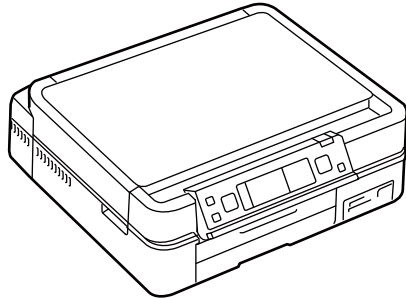
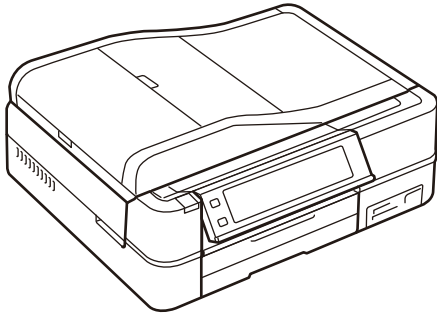


SERVICE MANUAL



Color Inkjet Printer

**Epson Artisan 800/
Epson Stylus Photo PX800FW/
Epson Stylus Photo TX800FW/
Epson Artisan 700/
Epson Stylus Photo PX700FW/
Epson Stylus Photo TX700FW**

PRECAUTIONS

Precautionary notations throughout the text are categorized relative to 1) Personal injury and 2) damage to equipment.

DANGER Signals a precaution which, if ignored, could result in serious or fatal personal injury. Great caution should be exercised in performing procedures preceded by DANGER Headings.

WARNING Signals a precaution which, if ignored, could result in damage to equipment.

The precautionary measures itemized below should always be observed when performing repair/maintenance procedures.

DANGER

1. ALWAYS DISCONNECT THE PRODUCT FROM THE POWER SOURCE AND PERIPHERAL DEVICES PERFORMING ANY MAINTENANCE OR REPAIR PROCEDURES.
2. NO WORK SHOULD BE PERFORMED ON THE UNIT BY PERSONS UNFAMILIAR WITH BASIC SAFETY MEASURES AS DICTATED FOR ALL ELECTRONICS TECHNICIANS IN THEIR LINE OF WORK.
3. WHEN PERFORMING TESTING AS DICTATED WITHIN THIS MANUAL, DO NOT CONNECT THE UNIT TO A POWER SOURCE UNTIL INSTRUCTED TO DO SO. WHEN THE POWER SUPPLY CABLE MUST BE CONNECTED, USE EXTREME CAUTION IN WORKING ON POWER SUPPLY AND OTHER ELECTRONIC COMPONENTS.
4. WHEN DISASSEMBLING OR ASSEMBLING A PRODUCT, MAKE SURE TO WEAR GLOVES TO AVOID INJURIES FROM METAL PARTS WITH SHARP EDGES.

WARNING

1. REPAIRS ON EPSON PRODUCT SHOULD BE PERFORMED ONLY BY AN EPSON CERTIFIED REPAIR TECHNICIAN.
2. MAKE CERTAIN THAT THE SOURCE VOLTAGES IS THE SAME AS THE RATED VOLTAGE, LISTED ON THE SERIAL NUMBER/RATING PLATE. IF THE EPSON PRODUCT HAS A PRIMARY AC RATING DIFFERENT FROM AVAILABLE POWER SOURCE, DO NOT CONNECT IT TO THE POWER SOURCE.
3. ALWAYS VERIFY THAT THE EPSON PRODUCT HAS BEEN DISCONNECTED FROM THE POWER SOURCE BEFORE REMOVING OR REPLACING PRINTED CIRCUIT BOARDS AND/OR INDIVIDUAL CHIPS.
4. IN ORDER TO PROTECT SENSITIVE MICROPROCESSORS AND CIRCUITRY, USE STATIC DISCHARGE EQUIPMENT, SUCH AS ANTI-STATIC WRIST STRAPS, WHEN ACCESSING INTERNAL COMPONENTS.
5. REPLACE MALFUNCTIONING COMPONENTS ONLY WITH THOSE COMPONENTS BY THE MANUFACTURE; INTRODUCTION OF SECOND-SOURCE ICs OR OTHER NON-APPROVED COMPONENTS MAY DAMAGE THE PRODUCT AND VOID ANY APPLICABLE EPSON WARRANTY.
6. WHEN USING COMPRESSED AIR PRODUCTS; SUCH AS AIR DUSTER, FOR CLEANING DURING REPAIR AND MAINTENANCE, THE USE OF SUCH PRODUCTS CONTAINING FLAMMABLE GAS IS PROHIBITED.

About This Manual

This manual describes basic functions, theory of electrical and mechanical operations, maintenance and repair procedures of the printer. The instructions and procedures included herein are intended for the experienced repair technicians, and attention should be given to the precautions on the preceding page.

Manual Configuration

This manual consists of six chapters and Appendix.

CHAPTER 1.PRODUCT DESCRIPTIONS

Provides a general overview and specifications of the product.

CHAPTER 2.OPERATING PRINCIPLES

Describes the theory of electrical and mechanical operations of the product.

CHAPTER 3.TROUBLESHOOTING

Describes the step-by-step procedures for the troubleshooting.

CHAPTER 4.DISASSEMBLY / ASSEMBLY

Describes the step-by-step procedures for disassembling and assembling the product.

CHAPTER 5.ADJUSTMENT

Provides Epson-approved methods for adjustment.

CHAPTER 6.MAINTENANCE

Provides preventive maintenance procedures and the lists of Epson-approved lubricants and adhesives required for servicing the product.

APPENDIX Provides the following additional information for reference:

- Exploded Diagram
- Parts List

Symbols Used in this Manual

Various symbols are used throughout this manual either to provide additional information on a specific topic or to warn of possible danger present during a procedure or an action. Be aware of all symbols when they are used, and always read NOTE, CAUTION, or WARNING messages.



Indicates an operating or maintenance procedure, practice or condition that is necessary to keep the product's quality.



Indicates an operating or maintenance procedure, practice, or condition that, if not strictly observed, could result in damage to, or destruction of, equipment.



May indicate an operating or maintenance procedure, practice or condition that is necessary to accomplish a task efficiently. It may also provide additional information that is related to a specific subject, or comment on the results achieved through a previous action.



Indicates an operating or maintenance procedure, practice or condition that, if not strictly observed, could result in injury or loss of life.



Indicates that a particular task must be carried out according to a certain standard after disassembly and before re-assembly, otherwise the quality of the components in question may be adversely affected.

Revision Status

Revision	Date of Issue	Description
A	August 27, 2008	First Release
B	December 10, 2008	<p>Revised Contents</p> <ul style="list-style-type: none"> <input type="checkbox"/> Chapter 3 <ul style="list-style-type: none"> ■ Made change and description has been added in Table 3-4 “Check point for Fatal error according to each phenomenon (Printer Mechanism)” (p58). ■ Made change and description has been added in Table 3-7 “Check point for Paper jam error according to each phenomenon” (p65). ■ Table 3-15 “Troubleshooting Abnormal Noise Problems” (p70) has been added. ■ Made change and description has been added in Table 3-16 “Troubleshooting Paper Feed Problems” (p70). ■ Made change and description has been added in Table 3-17 “Troubleshooting Paper Ejecting Problems” (p71). ■ Made change and description has been added in Table 3-18 “Troubleshooting Carriage Movement Problems” (p71). ■ Made change and description has been added in Table 3-19 “Troubleshooting Print Quality Problems” (p72). <input type="checkbox"/> Chapter 4 <ul style="list-style-type: none"> ■ Description has been added in 4.1.1 Precautions (p94). ■ Description has been added in 4.1.2 Tools (p95). ■ Description has been added in 4.1.3 Work Completion Check (p95). ■ Description has been added in 4.2 Disassembly Procedures (p99).

Revision	Date of Issue	Description
B	December 10, 2008	<ul style="list-style-type: none"> □ Chapter 4 <ul style="list-style-type: none"> ■ 4.2.1 Parts transferred from the old printer when replacing the Printer Mechanism (p101) has been added. ■ Made change in 4.2.2.1 ADF Unit (Artisan 800/PX800FW/TX800FW only) (p102). ■ Made change for reassembly in 4.2.2.2 Scanner Unit (p103). ■ Reassembly of 4.2.2.2 Scanner Unit (p103) has been added. ■ Caution of 4.2.3.2 Main Board / Grounding Plate M/B (p117) has been added. ■ Made change for caution in 4.2.4.1 Printhead (p124). ■ “PF Encoder” has been deleted. ■ “PF Scale” has been deleted. ■ Procedure and Checkpoint of 4.2.4.5 Ink Supply IC Holder Assy (p133) has been added. ■ Made change for reassembly in 4.2.4.6 Ink System (p135). ■ Procedure of 4.2.4.7 Lower ASF Paper Guide Assy (p138) has been added. ■ Made change in 4.2.4.8 CDR Tray Assy (p140). ■ Description has been added for reassembly in 4.2.4.11 Main Frame (p144). ■ Description has been added for reassembly in 4.2.4.13 EJ Frame Assy / EJ Release Frame Assy R/ EJ Release Frame Assy L (p147). ■ Made change in 4.2.4.14 PF Motor (p150). ■ Description has been added for reassembly in 4.2.4.16 Carriage Unit (p154). ■ Caution of 4.2.4.18 Rear Frame (p159) has been added. ■ Description has been added for reassembly in 4.2.4.19 Upper Paper Guide L/R / PE Sensor (p161). ■ “Paper Guide Front Assy” has been deleted. ■ Description has been added for reassembly in 4.2.4.20 Waste Ink Tray Assy (p163). ■ Procedure of 4.2.6.2 ADF Cover Assy/ADF Cover L (p175) has been added. ■ Made change for reassembly in 4.3.1.1 Scanner Unit (Artisan 700/PX700W/TX700W) (p185). ■ Caution of 4.3.2.2 Main Board/Grounding Plate M/B (Artisan 700/PX700W/TX700W) (p196) has been added.

Revision	Date of Issue	Description
B	December 10, 2008	<ul style="list-style-type: none"> <li data-bbox="674 181 953 240">☐ Chapter 5 Full-fledged revision <li data-bbox="722 261 1692 288">■ Made change and description has been added in Table 5-1 “Adjustment Items” (p210). <li data-bbox="722 309 1705 336">■ Made change and description has been added in Table 5-2 “Maintenance Items” (p213). <li data-bbox="722 357 1728 384">■ Made change and description has been added in Table 5-3 “Additional Functions” (p213). <li data-bbox="722 405 1776 432">■ Made change and description has been added in Table 5-4 “Required Adjustment List” (p216). <li data-bbox="722 453 1650 480">■ Check point of 5.2 Adjustment Using Adjustment Program (p219) has been added. <li data-bbox="722 501 1373 528">■ Made change in 5.2.4 Head Angular Adjustment (p221). <li data-bbox="722 549 1394 576">■ 5.2.7 PG Offset Value Adjustment (p225) has been added. <li data-bbox="722 596 1352 624">■ 5.2.8 Case Open Sensor Check (p226) has been added. <li data-bbox="722 644 1251 671">■ Made change in 5.2.9 AID inspection (p229). <li data-bbox="722 692 1896 751">■ Made change in 5.2.10 Banding Reduction System (BRS) Adjustment / Paper Feed Amount Profile (PFP) Correction (p230). <li data-bbox="722 772 1251 799">■ Made change in 5.3.1 PG Adjustment (p235). <li data-bbox="722 820 1482 847">■ Made change in 5.3.2 CR Timing Belt Tension Adjustment (p240). <li data-bbox="722 868 1478 895">■ Made change in 5.3.3 PF Timing Belt Tension Adjustment (p241). <li data-bbox="722 916 1944 975">■ Made change in 5.3.4 Touch Panel Adjustment (Epson Artisan 800/Epson Stylus Photo PX800FW/TX800FW only) (p242). <li data-bbox="722 995 1251 1023">■ 5.4.1 I/S Decompress (p244) has been added. <li data-bbox="722 1043 1314 1070">■ 5.4.2 AID SHK Error Reset (p245) has been added. <li data-bbox="674 1091 831 1118">☐ Chapter 6 <li data-bbox="722 1139 1425 1166">■ Lubrication point of 6.1.3 Lubrication (p249) has been added.

Revision	Date of Issue	Description
C	February 27, 2009	<p>Revised Contents</p> <ul style="list-style-type: none"> □ Chapter 4 <ul style="list-style-type: none"> ■ Made change and description of “Carriage Stopper jig” has been added in Table 4-1 “Tools” (p95). ■ Made change in 4.2.4.1 Printhead (p124). ■ Made change in “ Assembling the Printhead (p126)”. ■ Made change in 4.2.4.5 Ink Supply IC Holder Assy (p133). ■ Made change in 4.2.4.14 PF Motor (p150). ■ Made change in “ Main board (top side) (Artisan 800/PX800FW/TX800FW) (p203)”. ■ Made change in “ Main board (top side) (Artisan 700/PX700W/TX700W) (p204)”. □ Chapter 5 <ul style="list-style-type: none"> ■ PG adjustment has been added in Table 5-1 “Adjustment Items” (p210). ■ Made change and description has been added in Table 5-4 “Required Adjustment List” (p216). ■ Made change in 5.3.1 PG Adjustment (p235). ■ Made change in 5.3.3 PF Timing Belt Tension Adjustment (p241).

Contents

Chapter 1 PRODUCT DESCRIPTION

1.1 Features.....	13	1.7.2.4 Specifications for Handling Image Data.....	33
1.2 Printing Specifications.....	14	1.7.2.5 Memory Card Direct Print Menu.....	34
1.2.1 Basic Specifications.....	14	1.7.2.6 Makes Prints from Index Sheet Function.....	35
1.2.2 Ink Cartridge.....	14	1.7.2.7 Print Layout.....	36
1.2.3 Print Mode.....	15	1.7.3 Camera Direct Print Function (PictBridge).....	39
1.2.4 Supported Paper.....	17	1.7.3.1 Available DSC.....	39
1.2.5 Printing Area.....	19	1.7.3.2 Print Settings Available from DSC.....	39
1.3 Scanner Specifications.....	20	1.7.3.3 General Operation Procedure.....	40
1.3.1 Scanning Range.....	20	1.7.3.4 Operations when a DSC is connected.....	40
1.4 General Specifications.....	21	1.7.4 Various Settings (Setup Mode).....	41
1.4.1 Electrical Specifications.....	21	1.7.5 FAX Function (FAX Mode).....	43
1.4.2 Safety Approvals (Safety standards/EMI).....	21	1.7.5.1 Basic Specifications.....	43
1.4.3 Acoustic Noise.....	21	1.7.5.2 Supported Functions.....	43
1.4.4 Durability.....	22	1.7.6 Other Functions.....	46
1.4.5 Environmental Conditions.....	22	1.7.6.1 Scan Mode.....	46
1.5 Interface.....	23	1.7.6.2 Backup Data.....	46
1.5.1 USB Interface.....	23	1.7.6.3 Print Ruled Papers.....	46
1.5.2 FAX Interface.....		1.7.6.4 Coloring Book.....	
(Only Epson Artisan 800/Epson Stylus Photo PX800FW/TX800FW).....	23	(Only Epson Artisan 800/Epson Stylus Photo PX800FW/TX800FW).....	46
1.5.3 Network Interface.....	23		
1.5.4 Memory Card Slots.....	25		
1.6 Control Panel.....	26		
1.6.1 Operation Buttons & LEDs.....	26		
1.6.2 Control Panel Functions in Each Mode.....	27		
1.6.2.1 Control Panel Functions.....	27		
1.7 Specification for Each Function.....	29		
1.7.1 Stand-alone Copy Function (Copy Mode).....	29		
1.7.1.1 Supported Paper and Copy Mode.....	29		
1.7.1.2 Stand-alone Copy Menu.....	30		
1.7.1.3 Copy Speed (TBD).....	31		
1.7.1.4 Relation Between Original and Copy.....	31		
1.7.2 Memory Card Direct Print Function (Photos Mode).....	32		
1.7.2.1 Supported Paper and Print Mode.....	32		
1.7.2.2 Supported File Type and Media Type.....	32		
1.7.2.3 Automatic Detection of Images in Memory Card.....	33		

Chapter 2 OPERATING PRINCIPLES

2.1 Overview.....	48
2.1.1 Printer Mechanism.....	48
2.1.2 Printhead.....	48
2.1.3 Motors & Sensors.....	49
2.1.4 PG setting.....	51
2.1.5 Printer Initialization.....	52

Chapter 3 TROUBLESHOOTING

3.1 Overview.....	54
3.1.1 Specified Tools.....	54
3.1.2 Preliminary Checks.....	54
3.2 Troubleshooting.....	55
3.2.1 Motor and Sensor Troubleshooting.....	55
3.3 Troubleshooting by Error Message.....	56

3.3.1 Error Message List.....	56	4.2.2.9 Rear ASF Paper Guide Cover	111
3.3.2 Troubleshooting by Error Message	58	4.2.2.10 Rear Right FAX Housing	112
3.4 Troubleshooting without Error Message	70	4.2.2.11 Right Housing / Card Cover.....	113
3.4.1 Troubleshooting Printer Mechanism Problems	70	4.2.2.12 Cassette Unit	114
3.4.2 Troubleshooting Electrical Problems	76	4.2.2.13 Paper Guide Top Assy.....	115
3.4.3 Troubleshooting I/F-related Problems.....	76	4.2.3 Removing the Circuit Board.....	115
3.5 Troubleshooting Duplex Unit Problems.....	78	4.2.3.1 Panel Unit.....	115
3.6 Network Troubleshooting.....	79	4.2.3.2 Main Board / Grounding Plate M/B.....	117
3.7 FAX Troubleshooting		4.2.3.3 Power Supply Unit	121
(Epson Artisan 800/Epson Stylus Photo PX800FW/TX800FW only)	81	4.2.3.4 Wireless LAN Board.....	122
3.7.1 FAX Log.....	81	4.2.3.5 Card Slot Assy.....	123
3.7.2 Error Code/Superficial Phenomenon-Based Troubleshooting	85	4.2.4 Disassembling the Printer Mechanism	124
3.8 Fax Function/External Connection Function Check		4.2.4.1 Printhead.....	124
(Epson Artisan 800/Epson Stylus Photo PX800FW/TX800FW only)	87	4.2.4.2 CR Scale.....	129
3.8.1 Outline	87	4.2.4.3 Decompression Pump Unit.....	130
3.8.2 Fax Function and External Connection Function Check.....	87	4.2.4.4 CSIC Assy	132
3.8.2.1 Fax Function Check by [Method A] and External Connection Function Check	87	4.2.4.5 Ink Supply IC Holder Assy	133
3.8.2.2 Fax Function Check by [Method B] and External Connection Function Check	91	4.2.4.6 Ink System.....	135
3.8.2.3 Fax Function Check by [Method C] and External Connection Function Check	92	4.2.4.7 Lower ASF Paper Guide Assy	138
		4.2.4.8 CDR Tray Assy	140
		4.2.4.9 LD Roller.....	142
		4.2.4.10 Pick-up Roller	143
		4.2.4.11 Main Frame	144
		4.2.4.12 Front Frame.....	147
		4.2.4.13 EJ Frame Assy / EJ Release Frame Assy R/ EJ Release Frame Assy L	147
		4.2.4.14 PF Motor	150
		4.2.4.15 CR Motor.....	152
		4.2.4.16 Carriage Unit.....	154
		4.2.4.17 Transmission Holder Assy	158
		4.2.4.18 Rear Frame	159
		4.2.4.19 Upper Paper Guide L/R / PE Sensor	161
		4.2.4.20 Waste Ink Tray Assy	163
		4.2.4.21 Lower Paper Guide Waste Ink Pad Assy	165
		4.2.4.22 Front Paper Guide Waste Ink Pad.....	166
		4.2.5 Disassembling Scanner Unit.....	167
		4.2.5.1 Scanner Upper Housing (Artisan 800/PX800FW/TX800FW)	167
		4.2.5.2 Scanner Motor Unit.....	168
		4.2.5.3 Scanner Carriage Unit	169
		4.2.5.4 Scanner CR Encoder Board.....	172
		4.2.5.5 Cover Open Sensor.....	173
		4.2.6 Disassembly of the ADF Unit (Artisan 800/PX800FW/TX800FW only)	174

Chapter 4 DISASSEMBLY/ASSEMBLY

4.1 Overview	94
4.1.1 Precautions.....	94
4.1.2 Tools	95
4.1.3 Work Completion Check	95
4.1.4 Additional Procedure/Procedural Differences	97
4.2 Disassembly Procedures.....	99
4.2.1 Parts transferred from the old printer when replacing the Printer Mechanism	101
4.2.2 Removing the Housing	102
4.2.2.1 ADF Unit (Artisan 800/PX800FW/TX800FW only).....	102
4.2.2.2 Scanner Unit.....	103
4.2.2.3 Hinge	105
4.2.2.4 Upper Left Housing / Panel Lock Button.....	106
4.2.2.5 Upper Housing	107
4.2.2.6 Rear Left Housing	109
4.2.2.7 Left Housing / Decoration Belt L.....	109
4.2.2.8 Stacker Assy	110

4.2.6.1 ADF Hinge	174	5.2.9 AID inspection.....	229
4.2.6.2 ADF Cover Assy/ADF Cover L.....	175	5.2.10 Banding Reduction System (BRS) Adjustment / Paper Feed Amount Profile (PFP) Correction.....	230
4.2.6.3 ADF LD Frame Assy	176	5.2.10.1 BRS (Banding Reduction System) Adjustment	232
4.2.6.4 ADF Right Cover/ADF Rear Cover.....	176	5.2.10.2 PFP Adjustment.....	233
4.2.6.5 ADF Cover Stacker/ADF Document Support Cover	178	5.3 Adjustment without Using Adjustment Program	235
4.2.6.6 ADF Front Cover.....	179	5.3.1 PG Adjustment	235
4.2.6.7 ADF Document Support Assy.....	179	5.3.2 CR Timing Belt Tension Adjustment.....	240
4.2.6.8 ADF Frame Unit.....	180	5.3.3 PF Timing Belt Tension Adjustment.....	241
4.2.6.9 ADF Motor Unit.....	181	5.3.4 Touch Panel Adjustment (Epson Artisan 800/Epson Stylus Photo PX800FW/TX800FW only)	242
4.2.6.10 ADF PF Roller.....	183	5.4 Other functions	244
4.3 Disassembly/reassembly procedures specific to Artisan 700/PX700W/TX700W..	185	5.4.1 I/S Decompress.....	244
4.3.1 Removing the Housing	185	5.4.2 AID SHK Error Reset.....	245
4.3.1.1 Scanner Unit (Artisan 700/PX700W/TX700W)	185		
4.3.1.2 Upper Left Housing (Artisan 700/PX700W/TX700W)	187		
4.3.1.3 Upper Housing (Artisan 700/PX700W/TX700W).....	188		
4.3.1.4 Rear Left Housing (Artisan 700/PX700W/TX700W).....	190		
4.3.1.5 Left Housing/Decoration Belt L (Artisan 700/PX700W/TX700W)	191		
4.3.1.6 Rear Right Housing (Artisan 700/PX700W/TX700W)	192		
4.3.1.7 Right Housing/Card Cover (Artisan 700/PX700W/TX700W)	193		
4.3.2 Removing the Circuit Board (Artisan 700/PX700W/TX700W)	194		
4.3.2.1 Panel Unit (Artisan 700/PX700W/TX700W)	194		
4.3.2.2 Main Board/Grounding Plate M/B (Artisan 700/PX700W/TX700W)	196		
4.3.2.3 Card Slot Assy (Artisan 700/PX700W/TX700W)	199		
4.3.3 Disassembling the Scanner Unit (Artisan 700/PX700W/TX700W)	200		
4.3.3.1 Document Cover.....	200		
4.3.3.2 Scanner Upper Housing (Artisan 700/PX700W/TX700W).....	201		
4.4 Routing FFC/cables	202		

Chapter 5 ADJUSTMENT

5.1 Adjustment Items and Overview	210
5.1.1 Servicing Adjustment Item List.....	210
5.1.2 Required Adjustments	216
5.2 Adjustment Using Adjustment Program	219
5.2.1 Top Margin Adjustment	219
5.2.2 Bi-D Adjustment.....	219
5.2.3 PW Adjustment/First Dot Position Adjustment	220
5.2.4 Head Angular Adjustment	221
5.2.5 PF Adjustment	222
5.2.6 MAC Address Setting.....	223
5.2.7 PG Offset Value Adjustment.....	225
5.2.8 Case Open Sensor Check.....	226

Chapter 6 MAINTENANCE

6.1 Overview	248
6.1.1 Cleaning.....	248
6.1.2 Service Maintenance.....	248
6.1.2.1 Printhead cleaning.....	248
6.1.2.2 Service Call	249
6.1.3 Lubrication.....	249

Chapter 7 APPENDIX

7.1 Connector Summary.....	259
7.2 Exploded Diagram / Parts List	260

CHAPTER

1

PRODUCT DESCRIPTION

1.1 Features

Epson Artisan 800/Epson Stylus Photo PX800FW/TX800FW/Epson Artisan 700/Epson Stylus Photo PX700W/TX700W are color inkjet printers that have 4 in 1 functions (Printer for PC, Scanner for PC, Standalone copy, Memory card printing).

□ Common features

- Printer
 - Printing from a computer or directly printing from a memory card
 - Auto duplex printing using Duplex Printing Unit (option)
 - Built-in CD/DVD tray
 - Front double paper feeding function using a double-deck cassette
 - Auto nozzle check (cleaning) using AID
 - Maximum print resolution: SMGA 5760 (H) x 1440 (V) dpi
 - F6 Turbo II print head achieves higher print speed than ever (Black: 180 nozzles x 1, Color: 180 nozzles x 5 per color)
 - Six independent ink cartridges is installed (Dye inks)
 - Borderless printing on specified EPSON brand paper is available
- Scanner
 - Scanning from a computer
 - Offers a function that directly stores a scan data to a memory card
- Copy
 - High quality copy using the printing and scanning functions. Offers 13 preset copy layouts
- USB interfaces
 - Enables to print images in an external storage device
 - Backup copy of a memory card can be made on an external media
 - Offers camera direct print (PictBridge)
- Network
 - Available for printing, scanning, and memory card access via wired/wireless network
- Wireless
 - Mounting the optional Bluetooth unit offers wireless communication with an external device

□ Features unique to Epson Artisan 800/Epson Stylus Photo PX800FW/TX800FW

- FAX
 - Sending/receiving fax
- ADF
 - Continuous scanning using an ADF

□ Differences between the models

Epson Artisan 800/Epson Stylus Photo PX800FW/TX800FW/Epson Artisan 700/Epson Stylus Photo PX700W/TX700W are different on networking, FAX and the Panel specifications as shown below.

Item	Epson Artisan 800/Epson Stylus Photo PX800FW/TX800FW	Epson Artisan 700/Epson Stylus Photo PX700W/TX700W
LCD display size	3.5 inch	2.5 inch
Panel operation	Touch panel	Button
ADF	Equipped	---
FAX function	Supported	---
Network interfaces	Supported	Supported

□ Dimensions

- Epson Artisan 800/Epson Stylus Photo PX800FW/TX800FW
 - Dimensions*1: 466 mm (W) x 385 mm (D) x 198 mm (H)
 - Weight*2: 10.5 kg
- Epson Artisan 700/Epson Stylus Photo PX700W/TX700W
 - Dimensions*1: 466 mm (W) x 385 mm (D) x 150 mm (H)
 - Weight*2: 9.0 kg

Note *1: Paper support and stacker are closed. Rubber feet are included.

*2: Except ink cartridges and cables such as the AC cable, etc.

1.2 Printing Specifications

1.2.1 Basic Specifications

Table 1-1. Printer Specifications

Item	Specification
Print method	On-demand ink jet
Nozzle configuration	Black: 180 nozzles x 1 Color: 180 nozzles x 5 (Light Cyan, Magenta, Yellow, Cyan, Light Magenta)
Print direction	Bi-directional minimum distance printing, Unidirectional printing
Print resolution	Horizontal x Vertical (dpi) • 360 x 180 • 720 x 720 • 360 x 360 • SMGA 5760 x 1440 (1440 x 1440) • 720 x 360
Control code	• ESC/P Raster command • ESC/P-R (RGB) command • EPSON Remote command
Input buffer size	64 Kbytes
Paper feed method	Friction feed, using the ASF (Auto Sheet Feeder)
Paper path	Front feed, front out
Paper feed rates	T.B.D ms (at 25.4mm feed)
PF interval	Programmable in 0.01764 mm (1/1440 inch) steps

1.2.2 Ink Cartridge

The product numbers of the EPSON ink cartridges for this printer are shown below.

Table 1-2. Product No. of Ink Cartridges

Color	EAI	Latin/CISMEA/Asia	Euro
Black	T0981 (S)	T0811N (S) T0821N (2S)	T0791 (S) T0801 (2S)
Cyan	T0982 (S) T0992 (2S)	T0812N (S) T0822N (2S)	T0792 (S) T0802 (2S)
Magenta	T0983 (S) T0993 (2S)	T0813N (S) T0823N (2S)	T0793 (S) T0803 (2S)
Yellow	T0984 (S) T0994 (2S)	T0814N (S) T0824N (2S)	T0794 (S) T0804 (2S)
Light Cyan	T0985 (S) T0995 (2S)	T0815N (S) T0825N (2S)	T0795 (S) T0805 (2S)
Light Magenta	T0986 (S) T0996 (2S)	T0816N (S) T0826N (2S)	T0796 (S) T0806 (2S)

Shelf life

Two years from production date (if unopened), six months after opening package.

Storage Temperature

Table 1-3. Storage Temperature

Situation	Storage Temperature	Limit
When stored in individual boxes	-20 °C to 40 °C (-4°F to 104°F)	1 month max. at 40 °C (104°F)
When installed in main unit	-20 °C to 40 °C (-4°F to 104°F)	

Dimension

12.7 mm (W) x 68 mm (D) x 47 mm (H)



- Do not use expired ink cartridges.
- The ink in the ink cartridge freezes at -16 °C (3.2 °F). It takes about three hours under 25 °C (77°F) until the ink thaws and becomes usable.

1.2.3 Print Mode

Table 1-4. Print Mode (Color)

Media	Print Mode	Resolution (H x V) dpi	Dot Size (cps*1)	Bi-d	Micro Weave	Border-less
<ul style="list-style-type: none"> • Plain paper • Premium Bright White Paper (EAI) • Premium Bright White Inkjet Paper (others) 	Draft	360x180	Eco (450cps)	ON	OFF	N/A
	Normal	360x360	MC2-1 (360cps)	ON	OFF	N/A
	Photo Fine	720x720	MC1-1 (240cps)	ON	ON	N/A
<ul style="list-style-type: none"> • Ultra Premium Glossy Photo Paper (EAI) • Ultra Glossy Photo Paper (others) 	Photo*2	720x720 (1.0 pass)	MC1-2 (240cps)	ON	ON	OK
	Photo*2	720x720 (2.0 pass)	MC2-2 (280cps)	ON	ON	OK
	Super Photo	SMGA 5760x1440	MC1-5 (200cps)	ON	ON	OK
<ul style="list-style-type: none"> • Photo Paper Glossy (EAI) • Glossy Photo Paper (others) • Premium Photo Paper Glossy (EAI) • Premium Glossy Photo Paper (others) • Premium Photo Paper Semi-Gloss (EAI) • Premium Semigloss Photo Paper (other) 	Fine	720x360	MC1-2 (240cps)	ON	ON	OK
	Photo*2	720x720 (1.0 pass)	MC1-2 (240cps)	ON	ON	OK
	Photo*2	720x720 (2.0 pass)	MC2-2 (280cps)	ON	ON	OK
	Super Photo	SMGA 5760x1440	MC1-5 (200cps)	ON	ON	OK
<ul style="list-style-type: none"> • Premium Presentation Paper Matte (EAI) • Matte Paper - Heavyweight (others) 	Photo*2	720x720 (2.0 pass)	MC2-2 (280cps)	ON	ON	OK
	Super Photo	SMGA 5760x1440	MC1-5 (200cps)	ON	ON	OK
<ul style="list-style-type: none"> • Presentation Paper Matte (EAI) • Photo Quality Inkjet Paper*2 (others) 	Photo*2	720x720 (2.0 pass)	MC2-2 (280cps)	ON	ON	N/A
Envelope	Normal	360x360	MC2-1 (360cps)	OFF	OFF	N/A

Table 1-4. Print Mode (Color)

Media	Print Mode	Resolution (H x V) dpi	Dot Size (cps*1)	Bi-d	Micro Weave	Border-less
Double Matte Paper	Photo Fine	720x720	MC1-1 (240cps)	OFF	ON	N/A
	Photo*2	720x720 (2.0 pass)	MC2-2 (280cps)	ON	ON	N/A
Photo stickers	Photo*2	720x720 (2.0 pass)	MC2-2 (280cps)	ON	ON	N/A
<ul style="list-style-type: none"> • Iron-On Transfer Paper (EAI) • Iron-On Cool Peel Transfer Paper (others) 	Photo Fine	720x720	MC1-1 (240cps)	OFF	ON	N/A
CD/DVD Label*3	Super Photo	SMGA 5760x1440	MC1-5 (200cps)	ON	ON	N/A
High-quality CD/DVD Label*3	Super Photo	SMGA 5760x1440	MC1-5 (200cps)	ON	ON	N/A

Note *1: cps = character per second

*2: Photo mode uses 1.0 pass or 2.0 pass depending on the paper size.
1.0 pass supported size: 4" x6"
2.0 pass supported size: 5" x7", 8" x10", Letter, A4, 16:9 wide

*3: Print quality is not guaranteed in the settings other than [type: "CDR Tray" & media: "CD/DVD"] when carrying out CD/DVD printing from the PC.

Table 1-5. Print Mode (Monochrome)

Media	Print Mode	Resolution (H x V) dpi	Dot Size (cps*1)	Bi-d	Micro Weave	Border-less
• Plain paper • Premium Bright White Paper (EAI) • Premium Bright White Inkjet Paper (others)	Draft	360x180	Eco (450cps)	ON	OFF	N/A
	Normal	360x360	MC2-1 (360cps)	ON	OFF	N/A
	Photo Fine	720x720	MC1-1 (240cps)	ON	ON	N/A
• Ultra Premium Glossy Photo Paper (EAI) • Ultra Glossy Photo Paper (others)	Photo*2	720x720 (1.0 pass)	MC1-2 (240cps)	ON	ON	OK
	Photo*2	720x720 (2.0 pass)	MC2-2 (280cps)	ON	ON	OK
	Super Photo	SMGA 5760x1440	MC1-5 (200cps)	ON	ON	OK
• Photo Paper Glossy (EAI) • Glossy Photo Paper (others) • Premium Photo Paper Glossy (EAI) • Premium Glossy Photo Paper (others) • Premium Photo Paper Semi-Gloss (EAI) • Premium Semigloss Photo Paper (other)	Fine	720x360	MC1-2 (240cps)	ON	ON	OK
	Photo*2	720x720 (1.0 pass)	MC1-2 (240cps)	ON	ON	OK
	Photo*2	720x720 (2.0 pass)	MC2-2 (280cps)	ON	ON	OK
	Super Photo	SMGA 5760x1440	MC1-5 (200cps)	ON	ON	OK
• Premium Presentation Paper Matte (EAI) • Matte Paper - Heavyweight (others)	Photo*2	720x720 (2.0 pass)	MC2-2 (280cps)	ON	ON	OK
	Super Photo	SMGA 5760x1440	MC1-5 (200cps)	ON	ON	OK
• Presentation Paper Matte (EAI) • Photo Quality Inkjet Paper*2 (others)	Photo*2	720x720 (2.0 pass)	MC2-2 (280cps)	ON	ON	N/A
Envelope	Normal	360x360	MC2-1 (360cps)	OFF	OFF	N/A
	Photo Fine	720x720	MC1-1 (240cps)	OFF	ON	N/A

Table 1-5. Print Mode (Monochrome)

Media	Print Mode	Resolution (H x V) dpi	Dot Size (cps*1)	Bi-d	Micro Weave	Border-less
Double Matte Paper	Photo*2	720x720 (2.0 pass)	MC2-2 (280cps)	ON	ON	N/A
Photo stickers	Photo*2	720x720 (2.0 pass)	MC2-2 (280cps)	ON	ON	N/A
• Iron-On Transfer Paper (EAI) • Iron-On Cool Peel Transfer Paper (others)	Photo Fine	720x720	MC1-1 (240cps)	OFF	ON	N/A
CD/DVD Label*3	Super Photo	SMGA 5760x1440	MC1-5 (200cps)	ON	ON	N/A
High-quality CD/DVD Label*3	Super Photo	SMGA 5760x1440	MC1-5 (200cps)	ON	ON	N/A

Note *1: cps = character per second

*2: Photo mode uses 1.0 pass or 2.0 pass depending on the paper size.

1.0 pass supported size: 4" x6"

2.0 pass supported size: 5" x7", 8" x10", Letter, A4, 16:9 wide

*3: Print quality is not guaranteed in the settings other than [type: "CDR Tray" & media: "CD/DVD"] when carrying out CD/DVD printing from the PC.

1.2.4 Supported Paper

The table below lists the paper type and sizes supported by the printer. The supported paper type and sizes vary depending on destinations (between EAI, EUR, and Asia).

Table 1-6. Supported Paper

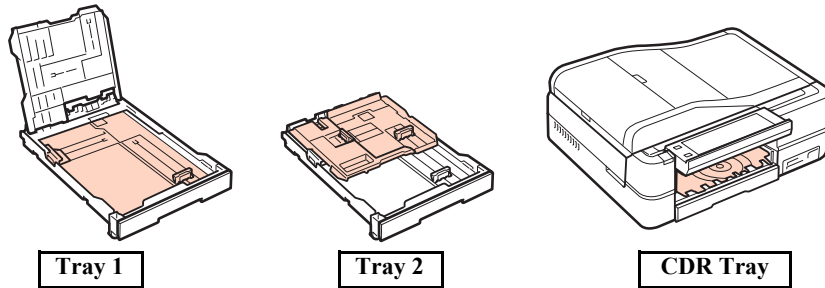
Paper Name	Paper Size		Thickness (mm)	Weight	EAI			EUR			Asia			Paper feed tray position*4		
					P*1	B*2	D*3	P*1	B*2	D*3	P*1	B*2	D*3	Tray 1	Tray 2	
Plain paper	Legal	215.9 x 355.6 mm (8.5"x14")	0.08-0.11	64-90 g/m ² (17-24 lb.)	Y	-	-	Y	-	-	Y	-	-	Y	-	
	Letter	215.9 x 279.4 mm (8.5"x11")			Y	-	Y	Y	-	Y	Y	-	Y	Y	-	
	A4	210 x 297 mm (8.3"x11.7")			Y	-	Y	Y	-	Y	Y	-	Y	Y	-	
	B5	182 x 257 mm (7.2"x10.1")			-	-	-	Y	-	Y	Y	-	Y	Y	-	
	A5	148 x 210 mm (5.8"x8.3")			-	-	-	Y	-	-	Y	-	-	Y	-	
	Half Letter	139.7 x 215.9 mm (5.5"x8.5")			Y	-	-	-	-	-	-	-	-	-	Y	-
	A6	105 x 148 mm (4.2"x5.8")			Y	-	-	Y	-	-	Y	-	-	-	-	Y
User Defined	89 x 127- 215.9 x 1117.6 mm (3.5"x5" - 8.5"x44")	Y	-	-	Y	-	-	Y	-	-	-	Y*5	-			
Premium Inkjet Plain Paper	A4	210 x 297 mm (8.3"x11.7")	0.11	80 g/m ² (21 lb.)	-	-	-	Y	-	Y	Y	-	Y	Y	-	
Premium Bright White Paper (EAI)	Letter	215.9 x 279.4 mm (8.5"x11")	0.11	90 g/m ² (24 lb.)	Y	-	Y	-	-	-	-	-	-	Y	-	
Bright White Inkjet Paper (Euro, Asia)	A4	210 x 297 mm (8.3"x11.7")	0.13	92.5 g/m ² (25 lb.)	-	-	-	Y	-	Y	Y	-	Y	Y	-	
Ultra Premium Glossy Photo Paper (EAI) Ultra Glossy Photo Paper (Euro, Asia)	Letter	215.9 x 279.4 mm (8.5"x11")	0.30	290 g/m ² (77 lb.)	Y	Y	-	-	-	-	-	-	-	Y	-	
	A4	210 x 297 mm (8.3"x11.7")			-	-	-	Y	Y	-	Y	Y	-	Y	-	
	8" x 10"	203.2 x 254 mm			Y	Y	-	-	-	-	-	-	-	-	Y	-
	5" x 7"	127 x 178 mm			Y	Y	-	Y	Y	-	-	-	-	-	-	Y
Premium Photo Paper Glossy (EAI) Premium Glossy Photo Paper (Euro, Asia)	Letter	215.9 x 279.4 mm (8.5"x11")	0.27	255 g/m ² (68 lb.)	Y	Y	-	-	-	-	-	-	-	Y	-	
	A4	210 x 297 mm (8.3"x11.7")			Y	Y	-	Y	Y	-	Y	Y	-	Y	-	
	8" x 10"	203.2 x 254 mm			Y	Y	-	-	-	-	-	-	-	-	Y	-
	5" x 7"	127 x 178 mm			Y	Y	-	Y	Y	-	Y	Y	-	-	-	Y
	4" x 6"	101.6 x 152.4 mm			Y	Y	-	Y	Y	-	Y	Y	-	-	-	Y
	16:9 wide	101.6 x 180.6 mm			-	-	-	Y	-	-	-	-	-	-	-	Y

Table 1-6. Supported Paper

Paper Name	Paper Size		Thickness (mm)	Weight	EAI			EUR			Asia			Paper feed tray position*4	
					P*1	B*2	D*3	P*1	B*2	D*3	P*1	B*2	D*3	Tray 1	Tray 2
Photo Paper Glossy (EAI) Glossy Photo Paper (Euro, Asia)	Letter	215.9 x 279.4 mm (8.5"x11")	0.25	258 g/m ² (68 lb.)	Y	Y	-	-	-	-	-	-	-	Y	-
	A4	210 x 297 mm (8.3"x11.7")			Y	Y	-	Y	Y	-	Y	Y	-	Y	-
	5" x 7"	127 x 178 mm			-	-	-	Y	Y	-	-	-	-	-	Y
	4" x 6"	101.6 x 152.4 mm			Y	Y	-	Y	Y	-	Y	Y	-	-	Y
Premium Photo Paper Semi-Gloss (EAI) Premium Semigloss Photo Paper (Euro, Asia)	Letter	215.9 x 279.4 mm (8.5"x11")	0.27	250 g/m ² (66 lb.)	Y	Y	-	-	-	-	-	-	-	Y	-
	A4	210 x 297 mm (8.3"x11.7")			-	-	-	Y	Y	-	Y	Y	-	Y	-
	4" x 6"	101.6 x 152.4 mm			Y	Y	-	Y	Y	-	Y	Y	-	-	Y
Premium Presentation Paper Matte (EAI) Matte Paper Heavy-weight (Euro, Asia)	Letter	215.9 x 279.4 mm (8.5"x11")	0.23	167 g/m ² (44 lb.)	Y	Y	-	-	-	-	-	-	-	Y	-
	A4	210 x 297 mm (8.3"x11.7")			-	-	-	Y	Y	-	Y	Y	-	Y	-
	8" x 10"	203.2 x 254 mm			Y	Y	-	-	-	-	-	-	-	Y	-
Ultra Premium Photo Paper Luster	Letter	215.9 x 279.4 mm (8.5"x11")	0.27	250 g/m ² (66 lb.)	Y	Y	-	-	-	-	-	-	-	Y	-
Double-sided Matte Paper	Letter	215.9 x 279.4 mm (8.5"x11")	0.22	185 g/m ² (49 lb.)	Y	Y	Y	-	-	-	-	-	-	Y	-
	A4	210 x 297 mm (8.3"x11.7")			-	-	-	Y	Y	Y	Y	Y	Y	Y	-
Photo Quality Inkjet Paper	Letter	215.9 x 279.4 mm (8.5"x11")	0.13	102 g/m ² (27 lb.)	Y	-	-	-	-	-	-	-	-	Y	-
	A4	210 x 297 mm (8.3"x11.7")			Y	-	-	Y	-	-	Y	-	-	Y	-
Envelopes	#10	104.8 x 241.3 mm (4.125"x9.5")	-	75-100 g/m ² (20-27 lb.)	Y	-	-	Y	-	-	Y	-	-	Y	-
	#DL	110 x 220 mm			-	-	-	Y	-	-	Y	-	-	Y	-
	#C6	114 x 162 mm			-	-	-	Y	-	-	Y	-	-	Y	-
Iron-On Transfer Paper (EAI) Iron-On Cool Peel Transfer Paper (others)	Letter	215.9 x 279.4 mm (8.5"x11")	0.14	130 g/m ² (35 lb.)	Y	-	-	-	-	-	-	-	-	Y	-
	A4	210 x 297 mm (8.3"x11.7")			-	-	-	Y	-	-	Y	-	-	Y	-
Photo Stickers 16	A6	105 x 148 mm (4.1"x5.8")	0.19	---	-	-	-	-	-	-	Y	-	-	-	Y
Photo Stickers 4	A6	105 x 148 mm (4.1"x5.8")	0.19	---	-	-	-	-	-	-	Y	-	-	-	Y
CD/DVD	ø12cm	ø12cm	---	---	Y	-	-	Y	-	-	Y	-	-	*6	-
	ø8cm	ø8cm	---	---	Y	-	-	Y	-	-	Y	-	-	*6	-
CD/DVD Premium Surface	ø12cm	ø12cm	---	---	Y	-	-	Y	-	-	Y	-	-	*6	-
	ø8cm	ø8cm	---	---	Y	-	-	Y	-	-	Y	-	-	*6	-

- Note *1: “Y” in the “P” column stands for “the paper type/size is Supported”.
 *2: “Y” in the “B” column stands for “Borderless printing is available”.
 *3: “Y” in the “D” column stands for “Duplex printing is available”.
 *4: See below for the Paper feed tray position.

Paper feed tray position



- *5: The paper other than the user definition range is not supported.
 *6: Front manual paper feeding with the built-in CDR Tray



- Make sure the paper is not wrinkled, fluffed, torn, or folded.
- The curve of paper must be 5 mm or below.
- When printing on an envelope, be sure the flap is folded neatly.
- Do not use the adhesive envelopes.
- Do not use double envelopes and cellophane window envelopes.

1.2.5 Printing Area

The printing area for this printer is shown below.

Table 1-7. Printing Area (Margins)

Print Mode	Paper Size	Margin			
		Left	Right	Top	Bottom
Standard print	Any size	3 mm	3 mm	3 mm	3 mm
	Envelope	5 mm	5 mm	3 mm	20 mm
Borderless print	4" x 6"	2.54 mm*	2.54 mm*	1.34 mm*	2.54 mm*
	Others			2.96 mm*	4.02 mm*

Note *: The margins for Borderless print are margins that bleed off the edges of paper.

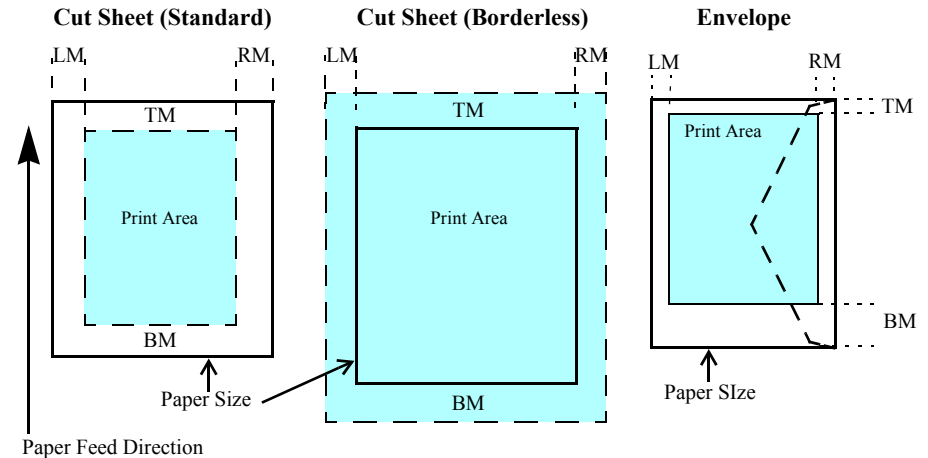


Figure 1-1. Printing Area

1.3 Scanner Specifications

Table 1-8. Basic Specifications

Item	Specification	
	Epson Artisan 800/Epson Stylus Photo PX800FW/TX800FW	Epson Artisan 700/Epson Stylus Photo PX700W/TX700W
Scanner type	Flatbed, color	
Scanning method	Moving carriage, stationary document	
Home position	The rear left corner	
Photoelectric device	CIS	
Light source	LED	
Maximum document sizes	A4 or US letter	
Scanning range	8.5" x 11.7" (216 mm x 297 mm)	
Maximum resolution	Main scan : 4,800 dpi (1,200 dpi*) Sub scan : 4,800 dpi (600 dpi*)	Main scan : 2,400 dpi Sub scan : 4,800 dpi
Maximum effective pixels	40,800 x 56,160 pixels	20,400 x 28,080 pixels
Pixel depth	16 bit per pixel (input) and 1 bit or 8 bit per pixel (output).	

Note *: When scanning using ADF

Table 1-9. ADF Specifications

(Only Epson Artisan 800/Epson Stylus Photo PX800FW/TX800FW)

Item	Specification
Document loading	Face-up
Maximum document sizes	A4 or US letter or Legal
Supported paper type	Plain paper only
Paper thickness	60 to 95 g/m ²
Maximum number of documents which can be set	30 sheets (Xerox-P 64 g/m ²) or 3mm (A4,US Letter) / 10 sheet (Legal)
Document path	Feeds from upper tray and ejects to lower tray
Document set position	Left back

1.3.1 Scanning Range

Table 1-10. Scanning Range

RL (read length)	RW (read width)	OLM (left margin)	OTM (top margin)
297 mm	216 mm	1.5 mm	1.5 mm

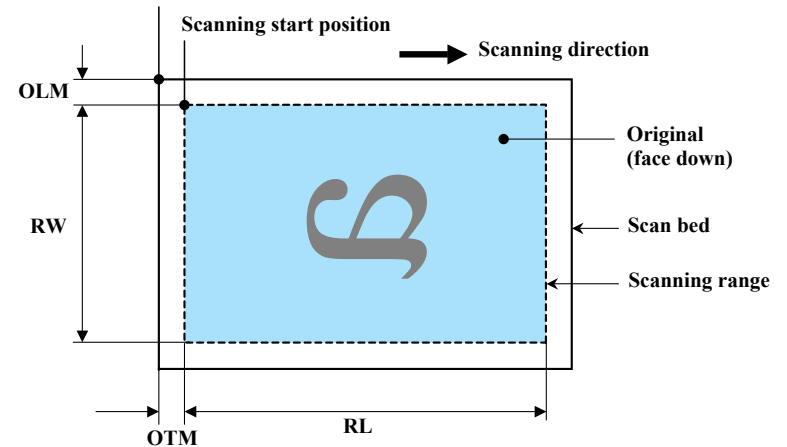


Figure 1-2. Scanning Range

1.4 General Specifications

1.4.1 Electrical Specifications

Table 1-11. Primary Power Specifications

Item	Epson Artisan 800/Epson Stylus Photo PX800FW/TX800FW		Epson Artisan 700/Epson Stylus Photo PX700W/TX700W		
	100-120 V model	220-240 V model	100-120 V model	220-240 V model	
Rated power supply voltage	100 to 120 VAC	220 to 240 VAC	100 to 120 VAC	220 to 240 VAC	
Input voltage range	90 to 132 VAC	198 to 264 VAC	90 to 132 VAC	198 to 264 VAC	
Rated current (Max. rated current)	0.8 A (1.6 A)	0.4 A (0.8 A)	0.8 A (1.6 A)	0.4 A (0.8 A)	
Rated frequency	50 to 60 Hz		50 to 60 Hz		
Input frequency range	49.5 to 60.5 Hz		49.5 to 60.5 Hz		
Energy conservation	International Energy Star Program compliant				
Power consumption	Copy (ISO/IEC24712 Pattern)	Approx. 26 W	Approx. 26 W	Approx. 25 W	Approx. 25 W
	Ready	Approx. 12 W	Approx. 12 W	Approx. 9.5 W	Approx. 9.5 W
	Sleep	Approx. 5.5 W	Approx. 5.5 W	Approx. 5.0 W	Approx. 5.0 W
	Off	Approx. 0.3 W	Approx. 0.5 W	Approx. 0.3 W	Approx. 0.5 W

Note : If the product has been idle status over 13 minutes, it goes into sleep mode within 2 minutes.

1.4.2 Safety Approvals (Safety standards/EMI)

USA	UL60950-1 FCC Part15 Subpart B Class B
Canada	CAN/CSA-C22.2 No.60950-1 CAN/CSA-CEI/IEC CISPR 22 Class B
Mexico	NOM-019-SCFI-1998
Taiwan*2	CNS13438 Class B CNS14336
EU	EN60950-1 EN55022 Class B EN61000-3-2, EN61000-3-3 EN55024
Germany	EN60950-1
Russia	GOST-R (IEC60950-1, CISPR 22)
Singapore*1	IEC60950-1
Korea	K60950-1 KN22 Class B KN61000-4-2/-3/-4/-5/-6/-11
China*2	GB4943 GB9254 Class B, GB17625.1
Hong Kong*2	IEC60950-1
Argentina*1	IEC60950-1
Australia	AS/NZS CISPR22 Class B

Note *1: Only Epson Artisan 700/Epson Stylus Photo PX700W/TX700W

*2: Only Epson Artisan 800/Epson Stylus Photo PX800FW/TX800FW

1.4.3 Acoustic Noise

□ Epson Artisan 800/Epson Stylus Photo PX800FW/TX800FW

- PC Printing*1: **T.B.D.** dB
- Scanning*2: **T.B.D.** dB

□ Epson Artisan 700/Epson Stylus Photo PX700W/TX700W

- PC Printing*1: 35 dB
- Scanning*2: 27 dB

Note *1: Premium Glossy Photo Paper/Highest quality

*2: default setting

1.4.4 Durability

Item	Durability	Remark
Total print life	Black	<ul style="list-style-type: none"> When printing A4 size sheet Black: 3.5% duty, Color: 5% duty
	Color	
Printhead	Six billions shots (per nozzle) or five years whichever comes first	
Scanner carriage	30,000 cycles of carriage movement	
Total ADF feeding*	10,000 pages	

Note *: Only Epson Artisan 800/Epson Stylus Photo PX800FW/TX800FW

1.4.5 Environmental Conditions

Table 1-12. Environmental Conditions

Condition	Temperature*1	Humidity*1,2	Shock	Vibration
Operating	10 to 35°C (50 to 95°F)	20 to 80%	1G (1 msec or less)	0.15G, 10 to 55Hz
Storage (unpacked)	-20 to 40°C*3 (-4°F to 104°F)	5 to 85%	2G (2 msec or less)	0.50G, 10 to 55Hz

Note *1: The combined Temperature and Humidity conditions must be within the blue-shaded range in Fig.1-3.

*2: No condensation

*3: Must be less than 1 month at 40°C.

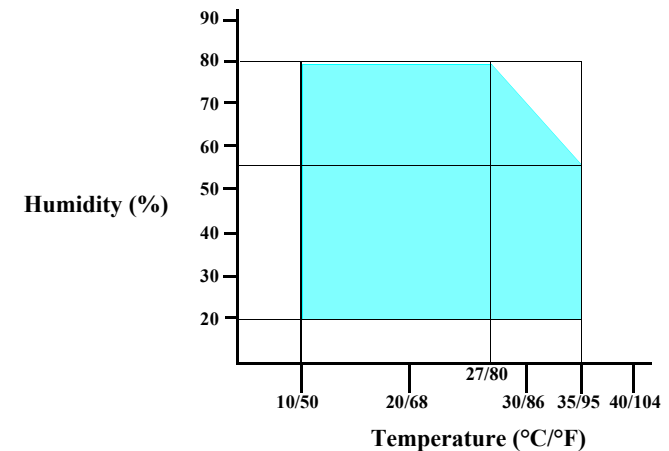


Figure 1-3. Temperature/Humidity Range



- When returning the repaired printer to the customer, make sure the Printhead is covered with the cap and the ink cartridge is installed.
- If the Printhead is not covered with the cap when the printer is off, turn on the printer with the ink cartridge installed, make sure the Printhead is covered with the cap, and then turn the printer off.

1.5 Interface

The following is the specifications of the USB Interface, Network Interface, FAX Interface (Only Epson Artisan 800/Epson Stylus Photo PX800FW/TX800FW), and Memory Card Slot mounted on this printer.

1.5.1 USB Interface

The table below describes the specifications of the two USB ports; USB device port for connecting with a host such as a computer, and the USB host port for connecting with an external devices such as a DSC (digital still camera).

Table 1-13. USB Interface Specifications

Item	USB Device port	USB Host port*
Compatible standards	<ul style="list-style-type: none"> Universal Serial Bus Specifications Revision 2.0 Universal Serial Bus Device Class Definition for Printing Devices Version 1.1 Universal Serial Bus Mass Storage Class Bulk-Only Transport Revision 1.0 	<ul style="list-style-type: none"> Universal Serial Bus Specifications Revision 2.0
Transfer rate	480 Mbps (High Speed)	480 Mbps (Max.)
Data format	NRZI	
Compatible connector	USB Series B	USB Series A
Max. cable length	2 [m] or less	

Note* : The following devices can be connected to the USB Host port.

- Devices compliant with DPS Version 1.0/1.1 (PictBridge)
- Devices compliant with Universal Serial Bus Mass Storage Class Bulk-Only Transport Revision 1.0, and the Subclass code is one of the followings.
 - 0x06 (SCSI transparent command set)
 - 0x05 (SFF-8070i command set)
 - 0x02 (SFF-8020i command set)

Table 1-14. Device ID

When IEEE 1284.4 is Enabled	When IEEE 1284.4 is Disabled
@EJL<SP>ID<CR><LF> MFG:EPSON; CMD:ESCPL2,BDC,D4,D4PX,ESCPRI; MDL:Model Name; CLS:PRINTER; DES:EPSON<SP>Model Name;	@EJL<SP>ID<CR><LF> MFG:EPSON; CMD:ESCPL2,BDC,ESCPRI; MDL:Model Name; CLS:PRINTER; DES:EPSON<SP>Model Name;

Note : The “Model Name” is replaced as shown in the following table.

Table 1-15. Model Names Indicated in the Device ID

Destination	Model Name	
	Epson Artisan 800/ Epson Stylus Photo PX800FW/TX800FW	Epson Artisan 700/ Epson Stylus Photo PX700W/TX700W
North America	Artisan 800	Artisan 700
Euro	Stylus Photo PX800FW	Stylus Photo PX700W
Asia/Pacific	Stylus Photo TX800FW	Stylus Photo TX700W

1.5.2 FAX Interface (Only Epson Artisan 800/Epson Stylus Photo PX800FW/TX800FW)

Port Name	Connector	Description
Line port	RJ11	Connects to phone cable from modular wall jack.
EXT port	RJ11	Connects to TAM or Telephone.

1.5.3 Network Interface

Epson Artisan 800/Epson Stylus Photo PX800FW/TX800FW/Epson Artisan 700/Epson Stylus Photo PX700W/TX700W can be connected to the network via Wired or Wireless LAN connection. (They can not be used simultaneously.) The following describes each Interface.

Wired LAN

The following interface is equipped for the Wired LAN connection. The communication mode can be selected from auto setting or fixed setting.

Table 1-16. Wired LAN

Item	Content
Connector	RJ-45 receptacle*: 1 port
Communication Speed	For either 10Base-T or 100Base-TX, the Full Duplex or Half Duplex can be selected.

Note* : 10Base-T/100Base-TX Ethernet is supported. MDI/MDI-X is selected automatically.

Table 1-17. Combination of the Wired LAN communication mode settings

Setting of this printer	Setting of the connected device
Auto Setting	Auto Setting (AUTO)
	100BASE-TX Half Duplex
	10BASE-T Half Duplex
100BASE-TX Full Duplex	100BASE-TX Full Duplex
100BASE-TX Half Duplex	Auto Setting (AUTO)
	100BASE-TX Half Duplex
10BASE-T Full Duplex	10BASE-T Full Duplex
10BASE-T Half Duplex	Auto Setting (AUTO)
	10BASE-T Half Duplex

Wireless LAN

The following interface is equipped for the Wireless LAN connection.

Table 1-18. Wireless LAN

Item	Content	
Applied Standard (2.4GHz spectrum band wireless network standards)	Conforms to IEEE802.11b, IEEE802.11g	
Wireless Operation Mode	IEEE802.11b	DS-SS (Half Duplex)
	IEEE802.11g	OFDM (Half Duplex)
Communication Range (line-of-sight distance)*	IEEE802.11b (11Mbps)	<ul style="list-style-type: none"> • 60m (indoor) • 220m (outdoor)
	IEEE802.11g (54Mbps)	<ul style="list-style-type: none"> • 20m (indoor) • 100m (outdoor)
Communication Mode	Ad-hoc (IBSS) or Infrastructure (ESS)	
Roaming Function	Not supported	
Output Signal Intensity	10mW	
Antenna	Built-in antenna (Diversity function is not supported)	

Note *: Referential value. It depends on surrounding conditions.

Table 1-19. Available Channels and Standard

Frequency Band (GHz)	Channel	IEEE Standard	Communication Speed (bps)*
2.400 - 2.4835	1 - 13	802.11b	11/5.5/2/1M
2.400 - 2.4835	1 - 13	802.11g	54/48/36/24/18/ 12/9/6M
2.471 - 2.497	14	802.11/11b	11/ 5.5/2/1M

Note "*": The communication speed will be changed automatically, depending on radio wave strength. bps = bit per second.

Switching Wired/Wireless LAN

This printer can be connect to the network via either Wired LAN or Wireless LAN connection only.

Enabling/disabling the Wireless LAN can be made from the Control Panel. When the Wireless LAN is enabled, it gets priority over the Wired Lan regardless of whether the LAN Cable is connected. The default Wireless LAN setting is "Disabled".

Table 1-20. Wireless LAN Setting from the Control Panel

Setting from Control Panel		LAN Cable Connection State	
		Connected	Disconnected
Wireless LAN	Disabled (Default)	Wired LAN	---*
	Enabled	Wireless LAN	Wireless LAN

Note* : No service via network is available without connecting the LAN Cable (because network communication is not established.) except printing a status sheet or the like.



When changing the networks while the power is on, wait at least for 10 seconds between disconnecting and reconnecting.

1.5.4 Memory Card Slots

CAUTION


If you insert a Memory Stick DUO to the Memory Card Slot without using the adapter, make sure to turn off the printer first, then remove the card using tweezers.

Table 1-21. List of Supported Memory Card

Priority	Slot	Compatible memory card	Standard	Max. capacity	Remarks
1	Memory Stick/ Memory Stick PRO	Memory Stick	“MemoryStick Standard” Format Specification Ver.1.43-00 compatible	128MB	Includes versions with memory select function
		MagicGate Memory Stick		128MB	Copy protection function is not supported
		MagicGate Memory Stick Duo			An adapter should be used
		Memory Stick PRO	MemoryStick PRO Format Specifications-without security specifications Ver.1.02-00 compatible	32GB	Copy protection function is not supported
		Memory Stick Duo	MemoryStick Duo Format Specification Ver.1.11-00 compatible		The Memory Stick Duo adapter should be used
		Memory Stick Pro Duo	MemoryStick PRO Duo Format Specification Ver.1.02-00 compatible		The Memory Stick Duo adapter should be used.
		Memory Stick micro	Memory Stick Micro Format Specification Ver.1.02-00 compatible		The Memory Stick adapter for standard size should be used.
	SD/MMC	SD (Security Digital)	SD Memory Card Specifications / PART1. Physical Layer Specification Ver. 2.0 compatible	2GB	
		miniSD/microSD			
		SDHC		32GB	
		miniSDHC/microSDHC			
		MultiMediaCard MultiMediaCard Plus	MultiMediaCard Standard Ver. 4.2 compatible	4GB/32MB	Only MultiMediaCard Plus supports up to 32GB.
	xD-Picture card	xD-Picture card	xD-Picture Card Specification Ver.1.20 compatible	2GB	Type M/H supported
2	CF Type II	Compact Flash	CF+ and CompactFlash Specification Revision 2.1 compatible	32GB	True-IDE compatible memory card only
		Microdrive			

- Note:
- Memory Stick/PRO, SD/MMC and xD-Picture Card shares the same slot.
 - When cards are inserted in the two slots at once, the slot which will be accessed first is determined according to the priority shown in the table.
 - To select a card that has been inserted in a non-active slot, first remove the card in the active slot.
 - In memory card direct printing mode, the image files in the active slot are valid and have assigned frame numbers. The number of images will not change if a card is inserted in another nonselected slot.
 - When the card inserted in the slot is accessed from the PC, only one drive is displayed at a time as a removable disk* and only the card that is in the active slot can be accessed via the removable disk. A card that has been inserted into a non-selected slot cannot be accessed. (This is for Windows. For Macintosh, the card in the active slot will be mounted on the desktop.)
 - Does not support 5V type of memory cards.
 - When a memory card is being accessed, do not touch the memory card.
 - For detailed information on the supported file system and formatting the memory card, refer to “1.7.2 Memory Card Direct Print Function (Photos Mode) (p. 32)”.

1.6 Control Panel

1.6.1 Operation Buttons & LEDs

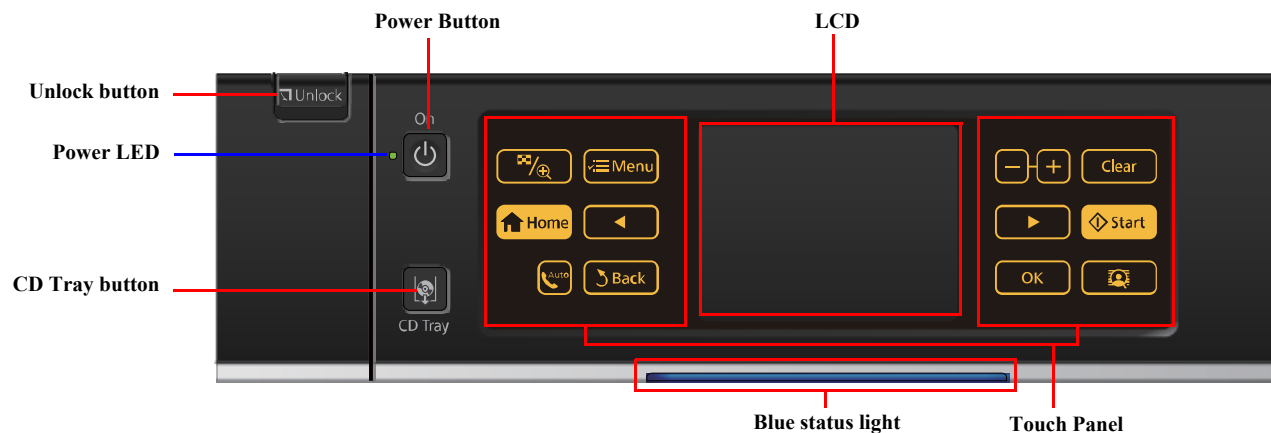


Figure 1-4. Control Panel (Epson Artisan 800/Epson Stylus Photo PX800FW/TX800FW)

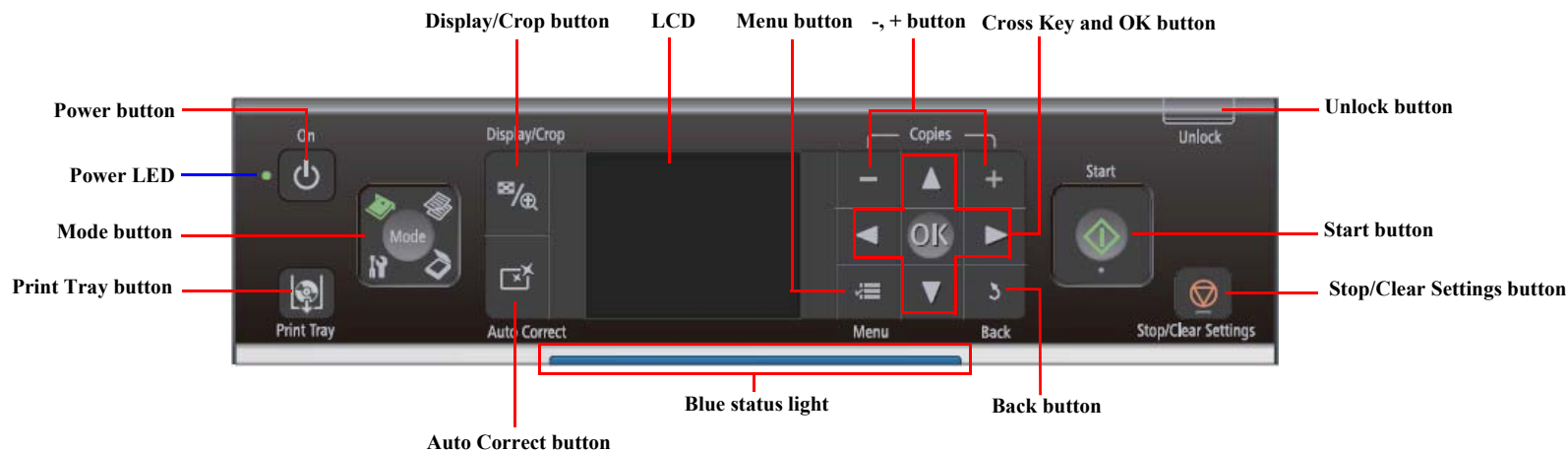


Figure 1-5. Control Panel (Epson Artisan 700/Epson Stylus Photo PX700W/TX700W)

Table 1-22. Button Functions
(Epson Artisan 800/Epson Stylus Photo PX800FW/TX800FW)

Button	Function
Power	Turns the power ON/OFF.
Touch Panel	Displays available buttons in each mode.
Unlock button	Release the lock of tilt adjustment of the Control Panel while pressing.
CD Tray	Ejects/retracts the CDR Tray.

Table 1-23. Button Functions
(Epson Artisan 700/Epson Stylus Photo PX700W/TX700W)

Button	Function
Power	Turns the power ON/OFF.
Display/Crop	<ul style="list-style-type: none"> • Goes to the zoom setting screen for the selected image. • Changes the image preview layout on the LCD.
-, +	Sets pages to print
Unlock	Release the lock of the Control Panel.
Start	Starts printing.
Stop/Clear Settings	<ul style="list-style-type: none"> • Stops operation and displays the menu screen. • Stops printing and ejects paper. • Returns the print settings in the current mode to their defaults and displays the Top screen. (Returns to the previous screen during printing maintaining the current settings)
Back	Cancels the previous operation.
Cross Key/OK	<ul style="list-style-type: none"> • Selects a menu item or a setting value. • Accepts the changed settings
Menu	Goes to the menu screen for each mode.
Auto Correct	Changes the Auto Correct ON/OFF.
Print Tray	Ejects/retracts the CDR Tray.
Mode	Changes modes in the following order. Copy/Photos/Scan/Backup Data/Print Ruled Papers/Setup/ Problem Solver/FAX

Table 1-24. LED

LED	Function
Power (Green)	<ul style="list-style-type: none"> • Flashes while powering ON/OFF. • Flashes during some sequence is in progress. • Flashes when a fatal/maintenance error occurs. • Lights when the status is other than above. (Stand by mode/during setting on the Panel, etc.)
Blue status light	Flashes or lights according to the printer status.

1.6.2 Control Panel Functions in Each Mode

1.6.2.1 Control Panel Functions

The table below shows the print setting menu items for each mode and their defaults, and when the settings are saved or returned to their defaults. Explanations on detailed control panel functions of the Epson Artisan 800/Epson Stylus Photo PX800FW/TX800FW/Epson Artisan 700/Epson Stylus Photo PX700W/TX700W are omitted here, because the LCD displays the detailed instruction.

Table 1-25. Timing of Saving or Initializing Control Panel Settings

Mode		Print Setting	Default Value
Copy	Normal Copy	Copy Type	Color
		Density	±0
		Layout	With Border
		2-Sided Printing	Off
		Reduce/Enlarge	Actual
		Paper Size	<ul style="list-style-type: none"> • EAI: Letter • Euro/Asia: A4
		Paper Type	Plain Paper
		Document Type	Text & Image
		Quality	Standard Quality
		Expansion	Standard
		Dry Time	Standard
		Binding Direction	Vertical-Short

Table 1-25. Timing of Saving or Initializing Control Panel Settings

Mode	Print Setting	Default Value		
Copy	Photo Copy	Color Restoration	Off	
		Paper Size	4 x 6 (10 x 15)	
		Paper Type	Prem. Glossy	
		Boderless	On	
		Expansion	Standard	
		Fix Photo	Fix Photo Off	
		Filter	Off	
	CD/DVD Print	CD Inner/Outer	Standard	
		Print Type	Print on a CD/DVD	
		Document Type	Text & Image	
		Quality	Best	
	Print Photo	<ul style="list-style-type: none"> • Print All Photos • View and Print Photos • Print Proof Sheet • Photo Layout Sheet • Print Index Sheet • Slide Show 	Select Photos	Select All Photos
			Paper Size	4 x 6 (10 x 15)
			Paper Type	Prem. Glossy
Borderless			On	
Layout			Boderless	
Quality			Standard	
Borderless			On	
Date			Off	
Print Info. On Photos			Off	
Fit Frame			On	
Bidirectional			On	
Fix Photo			Fix Photo On	
Scene Detection			Automatic	
Fix Red-Eye			Off - This photo	
Filter			Off	
Brightness			Standard	
Contrast			Standard	
Sharpness			Standard	
Saturation			Standard	
Print Proof SheetPaper			Paper Size	4 x 6 (10 x 15)
			Paper Type	Prem. Glossy
			infomation	File name

Table 1-25. Timing of Saving or Initializing Control Panel Settings

Mode	Print Setting	Default Value		
Print Photo	Photo Layout Sheet	Layout	2-up	
		Paper Size	4 x 6 (10 x 15)	
		Paper Type	Prem. Glossy	
		Layout Method	Automatic layout	
		Photo Layout	Place this photo	
		Quality	Standard	
		Expansion	Standard	
		Date	Off	
		Print Info. On Photos	Off	
		Fit Frame	On	
		Bidirectional	On	
		Print Index Sheet	Expansion	Standard
			CD/DVD Print	Layout
	Layout Method	Automatic layout		
	Photo Layout	Place this photo		
	CD Inner/Outer	Standard		
	Print Type	Print on a CD/DVD		
	CD Density	Standard Density		
	Fix Photo	Fix Photo On		
	Scene Detection	Automatic		
Fix Red-Eye	Off - This photo			
Filter	Off			
Brightness	Standard			
Sharpness	Standard			
Saturation	Standard			

Table 1-25. Timing of Saving or Initializing Control Panel Settings

Mode	Print Setting	Default Value		
Print Photo	Greeting Photo Card	Paper Size	• EAI: Letter • Euro/Asia: A4	
		Paper Type	Prem. Glossy	
		Layout	• EAI: 3-up • Euro/Asia: Borderless	
		Frame	Off	
		Fix Photo	Fix Photo On	
		Scene Detection	Automatic	
		Fix Red-Eye	Off - This photo	
		Filter	Off	
		Brightness	Standard	
		Contrast	Highest	
		Sharpness	Standard	
		Saturation	Standard	
		Play Movie and Print Photos (Only Epson Artisan 800/Epson Stylus Photo PX800FW/TX800FW)	Paper Size	4 x 6
			Paper Type	Prem. Glossy
Layout	• Borderless (Print 1 Frame) • 12-up (Print N Frame)			
Quality	Standard Quality			
Expansion	Standard			
Fit Frame	On			
Bidirectional	On			
Movie Enhance	On			
Fix Photo	Fix Photo On			
Filter	Off			
Brightness	Standard			
Contrast	Standard			
Sharpness	Standard			
Saturation	Standard			

Note : For the default value in FAX mode, refer to “1.7.5 FAX Function (FAX Mode) (p. 43)”.

1.7 Specification for Each Function

1.7.1 Stand-alone Copy Function (Copy Mode)

1.7.1.1 Supported Paper and Copy Mode

Table 1-26. Supported Paper and Copy Mode

Paper Type (UI notation)	Size	Print Quality	Resolution	Dot Size	Bi-d	Micro Weave
Plain	A4, A5*2 Letter*1	Draft	360x180	Eco	ON	OFF
		Standard	360x360	MC2-1	ON	OFF
		Best	720x720	MC1-1	ON	ON
Matte	A4, Letter*1	Standard	720x720	MC2-2	ON	ON
		Best	SMGA 5760x1440	MC1-5	ON	ON
Glossy/Glossy Paper	Letter*1, A4, 5x7*2, 4x6	Standard*3	720x720	MC1-2	ON	ON
		Standard	720x720	MC2-2	ON	ON
		Best	SMGA 5760x1440	MC1-5	ON	ON
Prem. Glossy	Letter*1, A4, 5 x 7, 8 x 10*1, 4 x 6	Standard*3	720x720	MC1-2	ON	ON
		Standard	720x720	MC2-2	ON	ON
		Best	SMGA 5760x1440	MC1-5	ON	ON
Ultra Glossy	Letter*1, A4, 5 x 7, 8 x 10*1, 4 x 6	Standard*3	720x720	MC1-2	ON	ON
		Standard	720x720	MC2-2	ON	ON
		Best	SMGA 5760x1440	MC1-5	ON	ON
CD/DVD	CD/DVD	Best	SMGA 5760x1440	MC1-5	ON	ON

Note *1: Supported only for EAI.

*2: Supported only for Euro/Asia.

*3: In the case of 4 x 6.

Note : In the case of copy using ADF, only the plain paper is available (Only Epson Artisan 800/Epson Stylus Photo PX800FW/TX800FW).

1.7.1.2 Stand-alone Copy Menu

The stand-alone copy mode menu for the Epson Artisan 800/Epson Stylus Photo PX800FW/TX800FW/Epson Artisan 700/Epson Stylus Photo PX700W/TX700W (settable items) are shown in the following tables.

Table 1-27. Copy Menus

Menu		Function
Number of copies		Sets the number of copies within the range of 1 to 99.
Copy type		Selects either color or monochrome.
Layout		Selects from layouts shown in Table 1-28 .
Double-sided printing*1		Selects either “On” or “Off”.
Print setting	Paper type	Selects paper type from the options shown in Table 1-26 .
	Paper size	Selects paper size from the options shown in Table 1-26 .
	Quality	Selects print quality from the options shown in Table 1-26 .
	Zoom	Selects zoom type from the 13 types below. <ul style="list-style-type: none"> • Actual (Sets any zoom with +/- key (25% to 400%) after selecting “Actual”) • Auto Fit Page • Legal > Letter • Letter > 4x6 • 4x6 > Letter • Letter > 5x7 • 5x7 > Letter • 4x6 > A4 • A4 > 4x6 • 5x7 > A4 • A4 > 5x7 • 4x6 > 8x10 • 8x10 > 5x7
Document Type		Selects from “Text”, “Text & Image”, “Photo”
Density		Selects from the nine density levels of -4 to +/-0 to +4.
Expansion (for borderless print)		Selects the margins level (margins bleed off the edges of paper) from the Standard (100%), Mid. (50%) or Min. (0%).*2

Note *1: Available when the Double-sided Printing Unit is installed.

*2: Percentages in parentheses indicate the proportion of the margin level to the maximum which bleeds off the edges of paper.

Note : When selecting the photo copy, “color restoration/filter” settings become available in addition to the above print settings.

Table 1-28. Copy Layout

Layout	Description
With Border	Makes a copy with 3mm of left/right/top/bottom white margins.
Borderless	Makes a copy with no white margins.
2-Sided 1-up*	Makes a double-sided copy of two sheets.
Book/2-Sided*	Makes a double-sided copy of two pages of a book.
2-up Copy	Make a scaling down copy of two sheets of A4 or B5 on one sheet.
2-Sided 2-up*	Make a scaling down double-sided copy of four sheets of A4 or B5.
Book/2-up	Make a scaling down copy of two pages of an A4 or B5 book on one sheet.

Note * : The layouts are available only when the duplex unit is installed.

Note : In the case of copy using ADF, only the plain paper is available.
(Only Epson Artisan 800/Epson Stylus Photo PX800FW/TX800FW)

1.7.1.3 Copy Speed (TBD)

- Not using ADF

Table 1-29. Copy Speed (Plain Paper)

Copy Conditions		Copy Speed (eMemo3, A4/Letter size)
Draft 360x180	Monochrome copy	39/40 cpm
	Color copy	39/39 cpm
Default 360x360	Monochrome copy	18.3/18.5 cpm
	Color copy	17.7/18.0 cpm

- Using ADF
(Only Epson Artisan 800/Epson Stylus Photo PX800FW/TX800FW)

Table 1-30. Copy Speed

Copy Conditions		Copy Speed	
		per copy	per five copies
Default	Monochrome copy	3.1 cpm	3.0 cpm
	Color copy	1.1 cpm	1.7 cpm
Best	Monochrome copy	0.8 cpm	0.4 cpm
	Color copy	0.8 cpm	0.4 cpm

1.7.1.4 Relation Between Original and Copy

The scanning start position is located on the front right of the scan bed. The relations between the original placed face down and its copy are as follows.

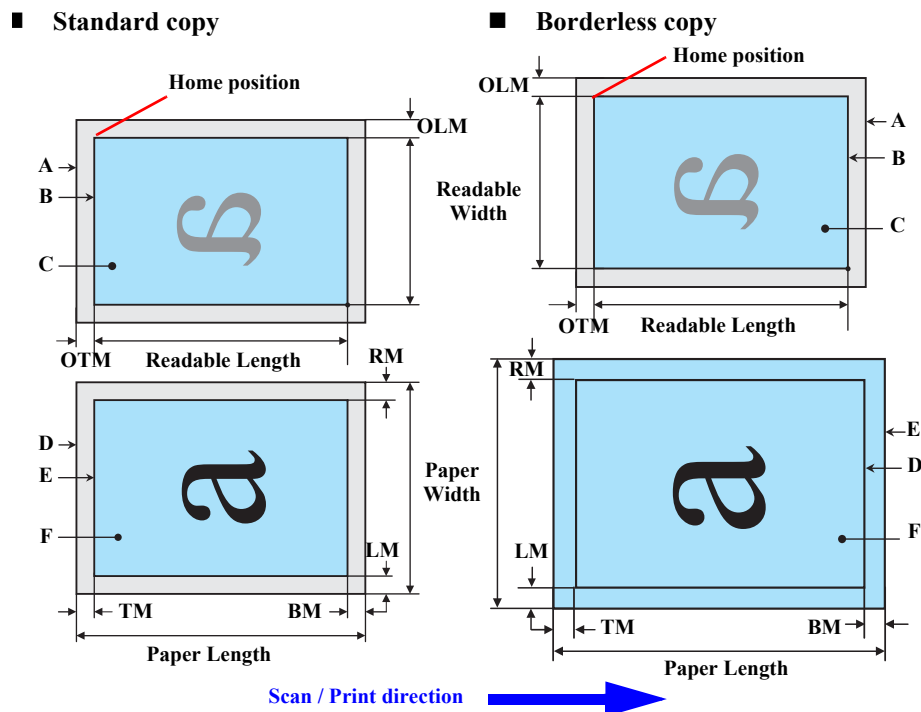


Figure 1-6. Relation Between Original and Copy (Borderless/With Borders)

Original Document

A	Scan bed	---
B	Scan area	"1-10 Scanning Range" (p.20)
C	Original (face down)	---
OTM	Top margin (out of scan range)	"1-10 Scanning Range" (p.20)
OLM	Left margin (out of scan range)	"1-10 Scanning Range" (p.20)

Copied Document

D	Copied paper	---
E	Print area	"1-7 Printing Area (Margins)" (p.19)
F	Copy	---
LM, RM	Left margin, Right margin*	"1-7 Printing Area (Margins)" (p.19)
TM, BM	Top margin, Bottom margin*	

1.7.2 Memory Card Direct Print Function (Photos Mode)

1.7.2.1 Supported Paper and Print Mode

Table 1-31. Supported Paper Type & Print Mode

Paper Type (UI notation)	Size	Print Quality	Resolution	Dot Size	Bi-d	Micro Weave
Plain	Letter* ¹ , A4,	Standard	360x360	MC2-1	ON	OFF
		Best	720x720	MC1-1	ON	ON
Matte	Letter* ¹ , A4	Standard	720x720	MC2-2	ON	ON
		Best	SMGA 5760x1440	MC1-5	ON	ON
Glossy/Glossy Paper	Letter* ¹ , A4, 5 x 7* ² , 4 x 6	Draft	720x360	MC1-2	ON	ON
		Standard* ³	720x720	MC1-2	ON	ON
		Standard	720x720	MC2-2	ON	ON
		Best Photo	SMGA 5760x1440	MC1-5	ON	ON
Prem. Glossy	Letter* ¹ , A4, 5 x 7, 8 x 10* ¹ , 4 x 6, 16:9wide	Draft	720x360	MC1-2	ON	ON
		Standard* ³	720x720	MC1-2	ON	ON
		Standard	720x720	MC2-2	ON	ON
		Best	SMGA 5760x1440	MC1-5	ON	ON
Ultra Glossy	letter* ¹ , A4, 5 x 7, 8 x 10* ¹ , 4 x 6, 16:9wide	Standard* ³	720x720	MC1-2	ON	ON
		Standard	720x720	MC2-2	ON	ON
		Best	SMGA 5760x1440	MC1-5	ON	ON
Photo Sticker ¹ * ²	A6	Standard	720x720	MC2-2	ON	ON
Photo Stickers* ²	100 x 148mm (3.9" x 5.8")	Standard	720x720	MC2-2	ON	ON
CD/DVD	CD/DVD	Best	SMGA 5760x1440	MC1-5	ON	ON

Note *1: Supported only for EAI.

*2: Supported only for Euro/Asia.

*3: In the case of 4 x 6.

1.7.2.2 Supported File Type and Media Type

The followings describe the file system, media format, and file type supported by the memory card direct function.

Table 1-32. Supported File System, Types and Media Format

Item		Specification
File system		DCF Version 1.0 or 2.0 * ¹ compliant. Other than those does not ensure proper operation. File systems available with the card reader function are restricted by the host's specification.
Media format	Memory card	<ul style="list-style-type: none"> • DCF Version 1.0 or 2.0 compliant • DOS FAT format (FAT12/FAT16/FAT32*²) with single partition (basic partitioned)
	CD-R	ISO9660 Level1 (Joliet) format
	DVD-R	<ul style="list-style-type: none"> • ISO9660 Level1 (Joliet) format • ISO9660 Level1 (Joliet) & UDF Bridge format*³
File type	JPEG (*.JPG)	Image files conform to Exif Version 2.21. (Exif version 1.0/2.0/2.1/2.2/2.21 are supported)
	Camera definition file (*.MRK)	Camera definition files used for DPOF mode. Valid if the full pass of the "AUTPRINT.MRK" is within 32 letters.
	P.I.F definition file (*.USD)	Print layout definition files compliant with PRINT Image Framer Rev.2.1 specifications. Files in "/EPUDL/" directory are valid.
	P.I.F definition file (*.FD2)	Print layout definition files compliant with PRINT Image Framer Rev.3.1 specifications. Files in a memory card are valid.

Note *1: Refer to the Camera File System Standard; "DCF Version 2.0, JEIDA-CP-3461" for more details.

*2: Available only when the memory card supports FAT32.

*3: UDF-formatted DVDs are not supported.

CHECK
POINT**The printer does not detect any files stored under the following directories or their sub-directories.**

- Directories containing system properties or hidden properties.
- “RECYCLED” (Windows directory for deleted files)
- “PREVIEW” (directories of CASIO DSC for thumbnail images)
- “SCENE” (directories of CASIO DSC for its Best Shot function)
- “MSSONY” (directories of SONY DSC for e-mail images, voice memos, movies, or non-compressed images)
- “DCIM\ALBUM\IMAGE” (directories of CASIO DSC for its album function)

1.7.2.3 Automatic Detection of Images in Memory Card

When a memory card is inserted in the card slot on the printer, or when a memory card is detected at power-on, the printer automatically searches for all images stored in the card. When the card is removed, the printer erases the information on the all detected files.

1.7.2.4 Specifications for Handling Image Data**Table 1-33. Specifications for Handling Image Data**

Item	Specification	Remarks
Image size (pixel)	<ul style="list-style-type: none"> • Horizontal: $80 \leq X \leq 9200$ • Vertical: $80 \leq Y \leq 9200$ 	---
Maximum number of images	Up to 9,990 images	When a memory card stores 9,990 or more images, the first 9,990 images are detected and become valid in the printer. The detecting order varies depending on the folder configuration in the card, so which images are included in the first 9,991 cannot be defined. However, images specified by camera definition files can be selected to be printed even when the total number of images has exceeded 9,990. Up to 999 camera defined image files can be specified.
Maximum number of copies	99 copies for each image. Up to 999 sheets in total.	---

Table 1-33. Specifications for Handling Image Data

Item	Specification	Remarks
Valid date and time	01/01/1980 00:00:00 to 12/31/2099 23:59:59	---
Thumbnail image data	Supports DCF Ver.1.0 or 2.0-compatible data (Exif format, 160x120 pixels)	Thumbnail images are used for the Print Index Sheet function.
File sorting	The printer sorts image files in ascending ASCII order based on their full-pathnames such as “\DCIM\100EPSON\EPSN0000.JPG”, and assigns a number to each of them. If over 1,000 files exist in the memory card, up to 999 files can be numbered and displayed on LCD. You can select which 999 files should be displayed from the menu on LCD.	<ul style="list-style-type: none"> • The image number assigned by the printer may be different from that assigned by the camera. • If two or more files have the same full pathname, the sorting function may not operate properly. (existence of the same full-pathname is not allowed under DOS)
Acquisition of date and time information	The printer acquires date and time information included in image files in the order of precedence shown below. 1. Date and time information in digital camera standard format (Exif) 2. Date and time information applied on DOS-compliant file system. 3. Fixed date and time information (01/01/1980, 00:00:00)	Date and time information included in an image file is not always the shooting date and time. It changes each time the image is edited and restored. The printer acquires the latest date and time information.

1.7.2.5 Memory Card Direct Print Menu

The following describes the menu (settable items) in Photos Mode of Epson Artisan 800/Epson Stylus Photo PX800FW/TX800FW/Epson Artisan 700/Epson Stylus Photo PX700W/TX700W.

Table 1-34. Memory Card Mode Menu

Menu Item	Function
View and Print Photos*1,2	Prints the selected images.
Print All Photos*1,2	Prints all images in a memory card. Specified number of copies is applied to the all images (the default is 1 copy). Specifying it for each of the images independently also can be made in the preview screen.
Print Proof Sheet	Prints an index sheet of the images in a memory card. Refer to Figure 1-9 for layout of the index sheet.
Print on CD/DVD	Prints the specified image as a CD/DVD label. Test printing on an A4 paper is also available.
Photo Greeting Card	Prints a template with specified images, and combines the images and hand writing on it by scanning it, then prints it on the 4 x 6 paper.
Photo Layout Sheet	Prints the images in a memory card with various layout. Refer to Figure 1-9 for layout.
Print Index Sheet	Print Index Sheet Prints an index sheet that prints images in a memory card in thumbnail form. The number of images to be included in the sheet can be selected from the following four options. “All image” (default), “Latest 30”, “Latest 60”, “Latest 90”*2
	Make Prints from Index Sheet Scans the Index Sheet, and prints images according to markings written on the sheet.
Play Movie and Print Photos (Only Epson Artisan 800/ Epson Stylus Photo PX800FW/ TX800FW)	Displays and prints a movies file (MotionJPEG/MPEG1) taken by the DSC, and stored in a memory card. Two types of printing, Print 1 Frame and Print N Frames are available.
Slide Show*3	Starts a slide show on the LCD. Images in a memory card is displayed one by one in the order sorted by the printer. Printing one of the images can be made from the paused screen.

Note *1: 0 to 99 copies can be specified for each of the images. Up to 999 copies in total.

*2: The images are listed in ASCII descending order.

*3: While performing the slide show, displaying number of copies, printing from an external device or from a computer cannot be made.

1.7.2.6 Makes Prints from Index Sheet Function

□ Print settings

Table 1-35. Print Settings

Item	Print Index Sheet	Makes Prints from Index Sheet
Number of copies	---	According to the marking on the index sheet.
Paper Type	Plain paper	
Paper Size	A4	
Layout	---	
Quality	Standard	Standard
Expansion	---	According to the setting made by the control panel.
Date	YYYY.MM.DD (2007.09.21)* ¹	According to the setting made by the control panel. YYYY.MM.DD (2007.09.21)* ¹
Bi-directional	On	On
Print Index Sheet Setting-Select	According to the setting made by the control panel.	---

Note *1: EAI model: MMM.DD.YYYY (Sep. 21.2007)

□ Rules on reading Index Sheet markings

The user can specify images to be printed and their print settings shown in [Table 1-35](#) by putting marking on the Index Sheet. The printer reads the markings according to the following rules.

Table 1-36. Rules on Reading Markings

Item	Mark	Description	Remarks
Left edge (one each)		Reference position for reading markings.	An error occurs if these markings cannot be read due to ink stain or any other cause.
Right edge (one each)		Reference position for reading markings.	
Block code (36 pcs.)		Sheet information (memory card, page)	
Image selection (30 pcs. x 3)		Selects the image to be printed.	An error occurs if no image selection marking is read.
Paper type/size (4 pcs.)		Selects the paper type/size.	An error occurs if two or more markings are read for one image.
Layout (2 pcs.)		Selects the layout.	An error occurs if two or more markings are read for one image. If no marking is read, borderless layout is applied.

Table 1-36. Rules on Reading Markings

Item	Mark	Description	Remarks
Date		Prints the date information.	When this marking is read, the date is printed on the image.

Note:

- About 50% or more range of the mark area must be marked out to be read by the printer.
- For running out and excessive marking out, the two white/black search patterns shown above are superimposed on the mark, and judgement is made according to this matching ratio.
- The judgement criteria is as follows;
black matching: 80% or more, white matching: 50% or more.
- The figure below shows the judgement example according to the rules described above.

<OK example>



<NG example>



□ Index Sheet errors

Table 1-37. Index Sheet Error List

Error Name	Description
Index sheet scan error (incorrect sheet setting)	The Index Sheet is not properly placed on the document glass.
Index sheet scan error (incorrect image selection marking)*	Image selection markings are not correct.
Index sheet scan error (incorrect paper selection marking)	Paper selection markings are not correct.
Index sheet scan error (unmatch between memory card and sheet)	The memory card may have been changed or some images may have been added or deleted after the Index Sheet is printed.

1.7.2.7 Print Layout

The following table describes supported layout for each paper type when printing the images. For printing area/margins in border-less printing or in bordered printing, refer to “1.2.5 Printing Area” (p.19). Other print layout are described in Figure 1-9.

Table 1-38. Supported Paper Type and Layout (1)

Paper Type (UI notation)	Corresponding Layout																	
	Borderless	With Border	Upper 1/2	Lower 1/2	2 up	4 up	8 up	20 up	16 up ^{*2}	Index-20 up	Index-30 up	Index-80 up	CD (With Border)	CD- 4 up	CD -variety	Jewel Case- Upper 1/2	Jewel Case- Index	Picture Package ^{*1}
Plain	---	O	---	---	O	O	O	O	---	---	---	O	O	O	O	O	O	O
Matte	O	O	O	O	O	O	O	O	---	---	---	O	---	---	---	O	O	O
Glossy Paper	O	O	O	O	O	O	O	O	---	O	O	O	---	---	---	O	O	O
Prem. Glossy	O	O	O	O	O	O	O	O	---	O	O	O	---	---	---	O	O	O
Ultra Glossy	O	O	O	O	O	O	O	O	---	O	O	O	---	---	---	O	O	O
PhotoSticker1	---	---	---	---	---	---	---	---	O	---	---	---	---	---	---	---	---	---
PhotoStickers	---	O	---	---	O	O	O	---	O	---	---	---	---	---	---	---	---	---
CD/DVD	---	---	---	---	---	---	---	---	---	---	---	---	O	O	O	---	---	---

Note *1: Supported only for EAI.

*2: Supported only for Euro/Asia.

*3: Prints in a layout of the CD/DVD label.

Note : Supported paper sizes differ depending on the types of paper.

Table 1-39. Supported Paper Type and Layout (2)

Paper Type (UI notation)	Corresponding Layout																
	Photo ID	PIF-1 up ^{*2}	PIF-n up ^{*2}	Camera Text	Index Sheet/ Photo Greeting Card Sheet	Photo Greeting Card- 3up-Greeting Card ^{*1}	Photo Greeting Card 1up (Borderless/with Border)	Photo Greeting Card- Upper 1/2	Photo Greeting Card- Lower 1/2	Reprint/Restore Photos (Borderless/With Border)	Note Print	Play movie and Print Photos- Print 1 frame (Borderless)	Play movie and Print Photos- Print 1 frame (With Border)	Play movie and Print Photos- Print 1 frame Upper 1/2	Play movie and Print Photos- Print 1 frame Lower 1/2	Play movie and Print Photos- Print 1 frame P.I.F. ^{*2}	Play movie and Print Photos- Print N frame 12 up
Plain	--	O	O	--	O	--	--	--	--	--	O	--	O	--	--	--	O
Matte	--	O	O	--	--	--	--	--	--	O	--	O	O	O	O	O	O
Glossy Paper	O	O	O	O	--	O	O	O	O	O	--	O	O	O	O	O	O
Prem. Glossy	O	O	O	O	--	O	O	O	O	O	--	O	O	O	O	O	O
Ultra Glossy	O	O	O	O	--	O	O	O	O	O	--	O	O	O	O	O	O
PhotoSticker1	--	--	--	--	--	--	--	--	--	--	--	--	--	--	--	--	--
PhotoStickers	--	O	O	--	--	--	--	--	--	--	--	--	--	--	--	--	--
CD/DVD	--	--	--	--	--	--	--	--	--	--	--	--	--	--	--	--	--

Note *1: Supported only for EAI.

*2: Supported only for Euro/Asia.

*3: Prints in a layout of the CD/DVD label.

Note : Supported paper sizes differ depending on the types of paper.

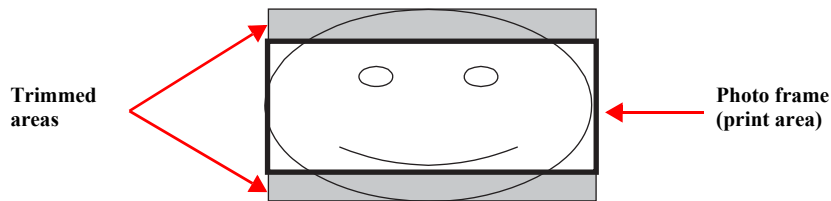
□ Trimming Function

A trimming function is provided as a means of coordinating an image with the types of photo frames handled by the printer. This function can be switched On/Off. This function is described briefly below.

The printed photo frame and an image to be printed are matched in length along one side and the image is resized along the perpendicular side to fit the frame on that side. Any part of the image that does not fit within the photo frame is trimmed away (not printed). However, if the number of pixels of the longer side of the image are more than twice as long as the shortest side, the trimming function is not effective when printing even the trimming is set. The trimming function is always set On if borderless or upper half layout is selected.

Trimming On

- When an image is aligned vertically with the photo frame.



- When an image is aligned horizontally with the photo frame.

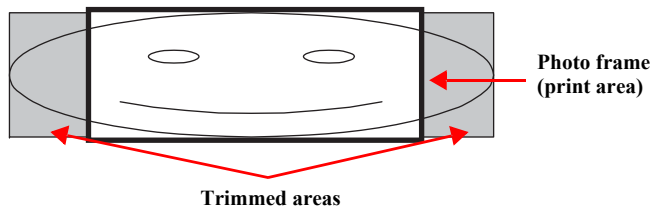
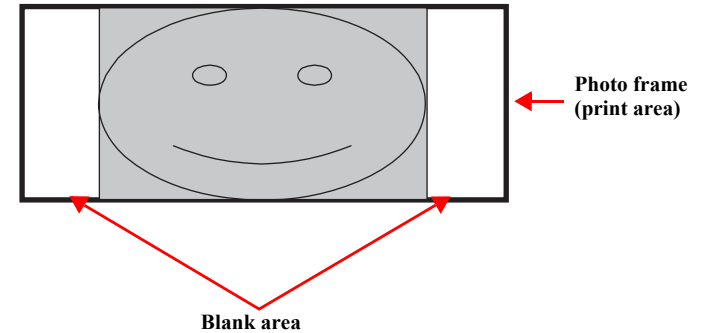


Figure 1-7. Trimming Function (when trimming is being operated)

Trimming Off

- When an image is aligned vertically with the photo frame.



- When an image is aligned horizontally with the photo frame.

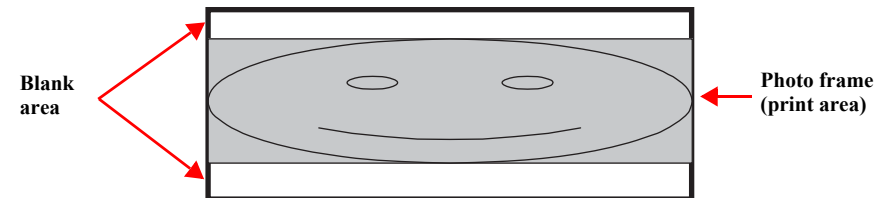


Figure 1-8. Trimming Function (when trimming is not operated)

□ Rules on Numbering and Rotating Images

The numbers shown in the figure below indicate the photo frame numbers used for the print layout. Horizontally oriented images are printed as shown by the numbers. Vertically oriented images, which has more pixels vertically than horizontally, the vertical photo data is allocated instead, and the number shown in the figure below is then rotated 90 degrees before being printed. In Index printing mode, the numbers are printed as they are shown below, regardless of the shape of the photo data.

However, when the photo data has an equal number of pixels vertically and horizontally the photos are printed without rotation, regardless of the layout.

NOTE: The vertical photo data refers to when the photo data file itself is set for a vertical (portrait) orientation. Photo data is defined as the vertical photo data if it is taken by a digital camera with a portrait position detecting function.)

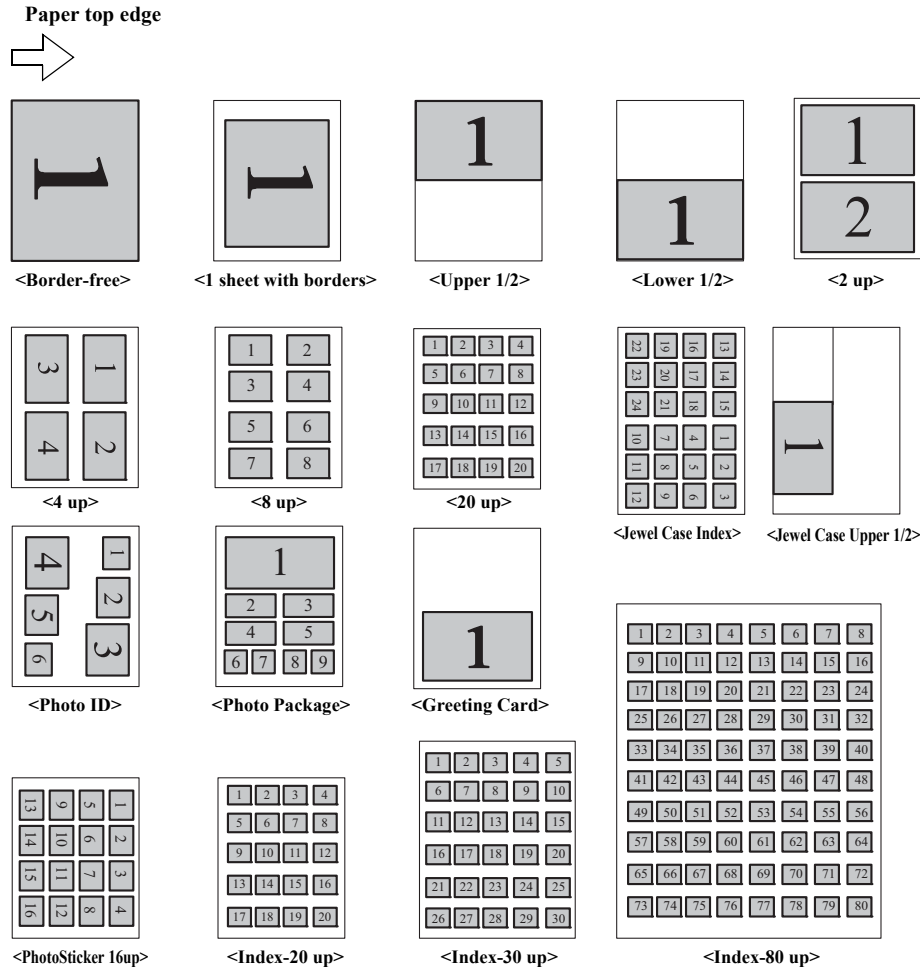


Figure 1-9. Rules on Numbering and Rotating Images

1.7.3 Camera Direct Print Function (PictBridge)

Printing operations (selecting images to be printed, making print settings, starting/canceling printing, and monitoring print process) can be carried out from a directly connected DSC (Digital Still Camera) that conforms to the standard described below.

1.7.3.1 Available DSC

Those devices which are compliant with “CIPA DC-001-2003 Digital Photo Solutions for Imaging Devices” (DPS Version 1.0) or “CIPA DC-001-2003 Rev.2.0, Digital Photo Solutions for Imaging Devices” (DPS Version 1.1).

1.7.3.2 Print Settings Available from DSC

The following print settings can be made from the DSC. However, depending on the DSC, some of the settings may not be available.

Table 1-40. Print Settings Available from DSC

Item	PictBridge
How to specify images	Single Sheet / Multiple Sheet / DPOF specified / XHTML-Print
Paper type	Plain Paper/ Prem. Glossy
Paper size	4 x 6, 5 x 7, 8 x 10, Letter (EAI model only), A4, 16:9wide, CD Label
Layout	Borderless / With Borders / 2-up / 4-up / 8-up / 20-up / Index/ CD-1 up with Border* / CD-4up* / CD-10up*
Date	On / Off
Quality	Not available
Auto Correct	On / Off
Trimming	Any specified area
Control of printer	The following operations are available; Getting the printer status, starting a print job or canceling it immediately or after printing the current page is finished.

Note* : When “Print on CD/DVD” is selected on the print setting menu.

1.7.3.3 General Operation Procedure



Before connecting the DSC, check that the printer is in the following status.

- No print job from a computer is processed or performed.
- Direct print from a memory card is not processed or performed.
- Stand alone copy using the scanner function is not operating.
- No paper out error or ink out error is occurring.

The DSC direct print procedure differs depending on the DSC specifications. The following explains common procedure.

1. Setting on the printer
Before connecting a DSC with a USB cable, make the print settings such as paper type/size, layout setting on the printer. This may not be required for some DSCs.
2. Setting on the DSC
Make the following settings on the DSC before connecting it to the printer. Some DSCs may require to first connect to the printer for making the settings.
 - When printing multiple images, specify images and number of copies using the DPOF and Multiple Sheet menus. The menus may not be available on some DSCs.
 - When printing a single image
Specify an image and the number of copies. Specifying the number of copies may not be available on some DSCs.
 - Select the paper type/size, layout, and make the Fit to Frame setting if necessary. These settings may not be available on some DSCs.
3. Starting to print
When the print settings on both the printer and the DSC is completed, follow the procedure below to start printing.
 1. Connect the printer and the DSC with a USB cable. Using a USB cable included in the DSC package is recommended.
 2. Operate the DSC to start printing.
 3. Printing is carried out according to the settings made on the DSC. When some print settings have not been made on the DSC, the corresponding settings made on the printer are applied.

1.7.3.4 Operations when a DSC is connected

Table 1-41. Operations during Connecting DSC

Operation	Specifications
Connecting DSC (print start)	When a DSC is connected as described in “1.7.3.3 General Operation Procedure (p. 40)” Step 3-1, Epson Artisan 800/Epson Stylus Photo PX800FW/TX800FW/Epson Artisan 700/Epson Stylus Photo PX700W/TX700W displays PictBridge logo on the LCD.
Canceling printing	A print job can be canceled from the DSC. The [Stop/Clear setting] button also cancels the print job.
After printing is completed	When performing memory card direct print after printing from a DSC, the USB cable connecting the DSC must be disconnected from the printer in advance.
Exclusion control	Print settings made on both the DSC and the printer can become impossible settings for the printer due to unsupported combination of paper type, paper size and layout. In such case, the print settings are automatically changed as follows. The settings made on the DSC are maintained. Any print setting items that are not specified by the DSC are changed in accordance with the DSC settings. When the paper type is changed, changed to Prem. Glossy, when the paper size is changed, changed to 4x6 size. And when the layout is changed, changed to Borderless layout.

1.7.4 Various Settings (Setup Mode)

Epson Artisan 800/Epson Stylus Photo PX800FW/TX800FW/Epson Artisan 700/Epson Stylus Photo PX700W/TX700W provides various configuration and maintenance. They can be done by selecting “Setup” from the menu on LCD. The following explains the outline of these menu functions.

Table 1-42. Menu List for Setup Mode

Item	Function
Ink Levels	<p>The current ink levels of each of the cartridges are displayed in bar chart by the rules described below.</p> <ul style="list-style-type: none"> The bar chart is displayed in the order of cyan, yellow, light cyan, black, magenta, and light magenta from the left. When initial filling is completed, or after replacing the cartridge, the ink level becomes 100% (full). The ink level is indicated in increment of 1%. Lower than 1% is rounded down.
Maintenance	<p>Runs various maintenance for the printer. The following shows each menu.</p> <ul style="list-style-type: none"> Nozzle Check A nozzle check pattern to check the Printhead nozzles status is printed. A head cleaning can be run if necessary. (Refer to Figure 1-10 for Printout pattern.) Head Cleaning Runs a printhead cleaning. The cleaning cannot be made when low ink level is detected. In such case, an ink low error is displayed instead of running the cleaning. Head Alignment Adjustment to improve the bi-directional print quality. Head alignment icon and the instructions for the adjustment are displayed on the LCD. Automatic Head Maintenance Selects On/Off of the auto head cleaning.

Table 1-42. Menu List for Setup Mode

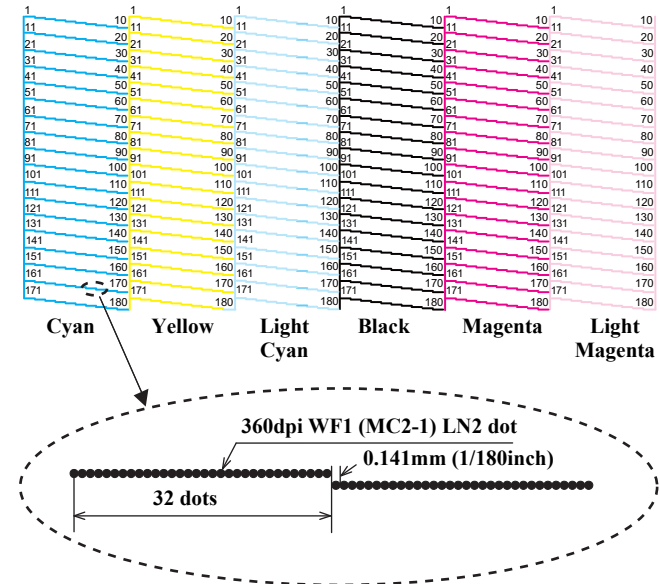
Item	Function
	<p>Changes settings for the printer. The menu is described below.</p> <ul style="list-style-type: none"> CD/DVD Alignment Makes the printing position adjustment for CD/DVD label. Stickers (Euro/Asia only) Makes the printing position adjustment for Stickers. Thick Paper Selects On/Off of friction reduction between paper and printhead.
Printer Setup	<ul style="list-style-type: none"> Sound Selects On/Off of the settings of beep sound*, audio output, and also selects the volume. Screen Saver Settings If the panel is not used in stand-by mode, plays a slide show using the images in a memory card as the screen-saver. Display Format The screen when displaying a photo can be selected from the following three types. <ul style="list-style-type: none"> ■ 1-up with Info ■ 1-up without Info ■ View Thumbnail Images Use Selected P.I.F. Frame with Photo Selects On/Off of photo printing using P.I.F frame. Date/Time* Daylight Saving Time* Country/Region* Language

Table 1-42. Menu List for Setup Mode

Item	Function
Network Settings	<p>Changes settings for Network.</p> <ul style="list-style-type: none"> • Confirm Network Settings Displays the current settings. Status Sheet can be printed. (Refer to Figure 1-11.) • General Network Setup Changes settings for printer name and TCP/IP (auto/manual). • Wireless LAN Setup Enabling/disabling Wireless LAN. • File Sharing Setup Changes settings of the files in a memory card for file sharing via network.
Home Network Print Settings	Makes the print settings via home networking using such as a digital TV or PC.
Fax Setting (Only Epson Artisan 800/Epson Stylus Photo PX800FW/TX800FW)	Changes settings for FAX. Refer to “ 1.7.5 FAX Function (FAX Mode) (p.43) ”.
Bluetooth Settings	Changes settings for Bluetooth.
PictBridge Setup	The print settings and color correction to be used for the camera direct print (PictBridge) can be selected and set. When print conditions (paper type, paper size, layout, quality, and auto correct) are specified from the DSC, the DSC settings take priority over the settings made here. For details, refer to “ 1.7.3 Camera Direct Print Function (PictBridge) (p.39) ”.
Select Location	Selects a folder when printing from an external device other than DSC.
Restore Default Settings	<p>Restores the default settings for FAX and Network.</p> <ul style="list-style-type: none"> • Individual initialization of FAX or network settings is available for Epson Artisan 800/Epson Stylus Photo PX800FW/TX800FW. • Individual initialization of network or other settings is available for Epson Artisan 700/Epson Stylus Photo PX700W/TX700W.

Note* : Only Epson Artisan 800/Epson Stylus Photo PX800FW/TX800FW.

Note : When the settings for the network are changed, network connection may be interrupted temporarily.



Note : The numbers shown in the figure are nozzle numbers. The numbers and the color names are not printed on an actual nozzle check pattern.

Figure 1-10. Nozzle Check Pattern

□ Print

Function	Specification
Paper size	Letter/A4/legal*1
Paper type	Fixed to plain paper
Resolution	Standard: 360 x 360 dpi
Dot size	MC2-1
Bi-directional	Available
Microweave	N/A
Borderless printing	N/A
Automatic reduction	<u>On</u> /Off
Backup fax reception and reprint	Available
List	Type: Last transaction (<u>off</u> /send error/every send) Fax log (last 30 transactions) Speed dial list Power-fail report Protocol trace
	Font size: 12pt
	Language: Depends on destination
Size mismatch	Print*2
Footer	N/A

Note *1: The default setting is letter for US/Canada/Mexico and A4 for other destinations.

*2: The printer stops printing after printing the first page on the current paper. The received fax images (data) can be reprinted.

□ User Setting

Function	Specification
Volume	Buzzer: <u>On</u> /Off
Date and time	Display*: yyyy.mm.dd.hh:mm (12h/24h)
	Backup: N/A
	Daylight time: Available
Pending job viewer	N/A (cannot reserve)
Elapsed time	Available (displays time to redial)
External memory	N/A
Language	Depends on destination
Audio monitor	Available (buzzer)

Note* : The display format can be changed from the Set up menu.

□ Dialing

Function	Specification	
Speed dial	Total registration	60 (Max.)
	Characters available for registering number	1-9, 0, space, *, #, - (pause), space
	Total digits for registering number	64 (Max.)
	Characters available for registering name	a-z, A-Z, 1-9, 0, @, _ - & / ; : , ? * () ' = + # ! % ~ , space
	Total characters for registering name	40 (Max.)
	Options	N/A
	Selection method	Press the Menu button to display the menu
	Function	Recalls fax numbers*1
One-touch dial	N/A	
Group dial	N/A	
Direct dial	Total digits	64 (Max.)
Redial	Busy	Fixed to two times
	No answer	
	Buffer	Last one number
Redial interval	Fixed to one minute	
Redial attempts	Fixed to two times	
Dial mode	Pulse	
PBX	N/A	
Dial prefix	N/A	
On-hook dialing	N/A	

Note *1: The fax numbers can be edited from the Fax settings menu.

□ Answering

Function	Specification
Auto answer	On/Off (with answer mode button)
	Ring to answer: 1-9 times*
DRD	All/single/double/triple/double&triple
TAM/IF	Available
Easy receive	N/A
Answer prefix	N/A
Caller ID	N/A
FAX/TEL mode	N/A
Remote receive/remote telephone	N/A

Note* : The default depends on destination.

□ Transmission

Function	Specification	
Sequential broadcast	N/A	
Direct transmission	Color only	
Memory transmission	Monochrome only	
Delayed memory transmission	Available	
Multi-page transmission	Total pages	100 (Max.)
	Data compression	Monochrome: MH/MR/MMR*1 Color: JPEG
Transmission reservation	N/A	
Fax header (Owner information)	Characters available	a-z, A-Z, 1-9, 0, @, _ - & / ; : , ? * () ' = + # ! % ~ , space
	Total characters	40 (Max.)
Fax header (Own number)	Characters available	1-9, 0, +, space
	Total characters	40 (Max.)
Overseas mode	N/A	
Poll to send	N/A	

Note *1: The compression method is automatically selected depending on the receiver.

Reception

Function	Specification
FAX forwarding	N/A
Block junk faxes	N/A
Block no-ID calls	N/A
Poll to receive	Available

 Communication

Function	Specification
ECM	On/Off
V.34	On/Off
Region	Depends on destination
JBIG	N/A

 Telephone

Function	Specification
External telephone	Jack: Available
	Handset: N/A
	Hook detect: Available
	Manual send: Available
	Manual receive: Available

 Others

Function	Specification
Power save mode	Available
Receive and print during power off	N/A
Copy during faxing	N/A
Scan during faxing	N/A
Save received data during power off	N/A

1.7.6 Other Functions

Epson Artisan 800/Epson Stylus Photo PX800FW/TX800FW/Epson Artisan 700/Epson Stylus Photo PX700W/TX700W allows you to use various functions by selecting one of the following modes from the menu on LCD.

1.7.6.1 Scan Mode

- Scan to Email
- Scan to Memory Card
- Scan to PC
- Scan to PDF

When “Scan to Memory Card” is selected, you can change settings for saving format, scanning range, document type, and saving quality according to the instructions displayed on the LCD. After scanning, the scanned data is saved in the memory card. As for other menus, the Epson Scan installed in PC is activated and runs each function.

1.7.6.2 Backup Data

You can save data as a back up from the file in the memory card to the file in the externally-connected CDR drive, etc. or delete all the files in the memory card.

1.7.6.3 Print Ruled Papers

You can print ruled lines on A4 plain paper for use of a sheet of notebook or a letter by operating according to the instructions displayed on the LCD. Ten types of ruled lines are available.

1.7.6.4 Coloring Book (Only Epson Artisan 800/Epson Stylus Photo PX800FW/TX800FW)

Scans the document on the document table, and traces the outline automatically, and prints the outline as a coloring sheet. As the auto outline tracing, three types of setting are available; “People”, “Scenery” and “Line Drawing”.

CHAPTER

2

OPERATING PRINCIPLES

2.1 Overview

This section describes the operating principles of the Printer Mechanism of Epson Artisan 800/Epson Stylus Photo PX800FW/TX800FW/Epson Artisan 700/Epson Stylus Photo PX700W/TX700W.

2.1.1 Printer Mechanism

The following describes the mechanism, motors and sensors that construct the printer.

2.1.2 Printhead

- Printing method : On demand inkjet (F6-Shrink head)
- Nozzle

Color	Bk, C, M, Y, Lc, Lm (6 colors)
Nozzle	1,080 nozzle (Each color 180 nozzle x 6 lines)
Nozzle pitch	0.141 mm for each line (1/180 inch)

The nozzle layout as seen from behind the printhead is shown below.

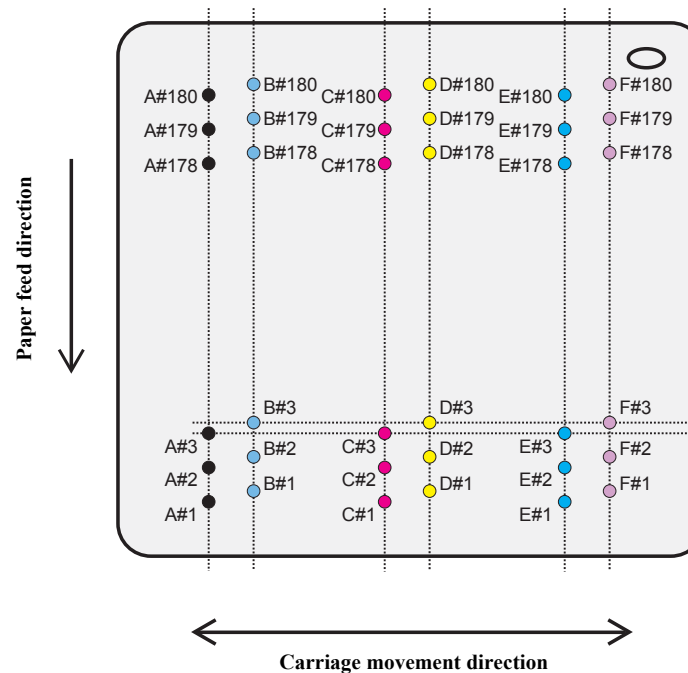


Figure 2-2. Nozzle Layout

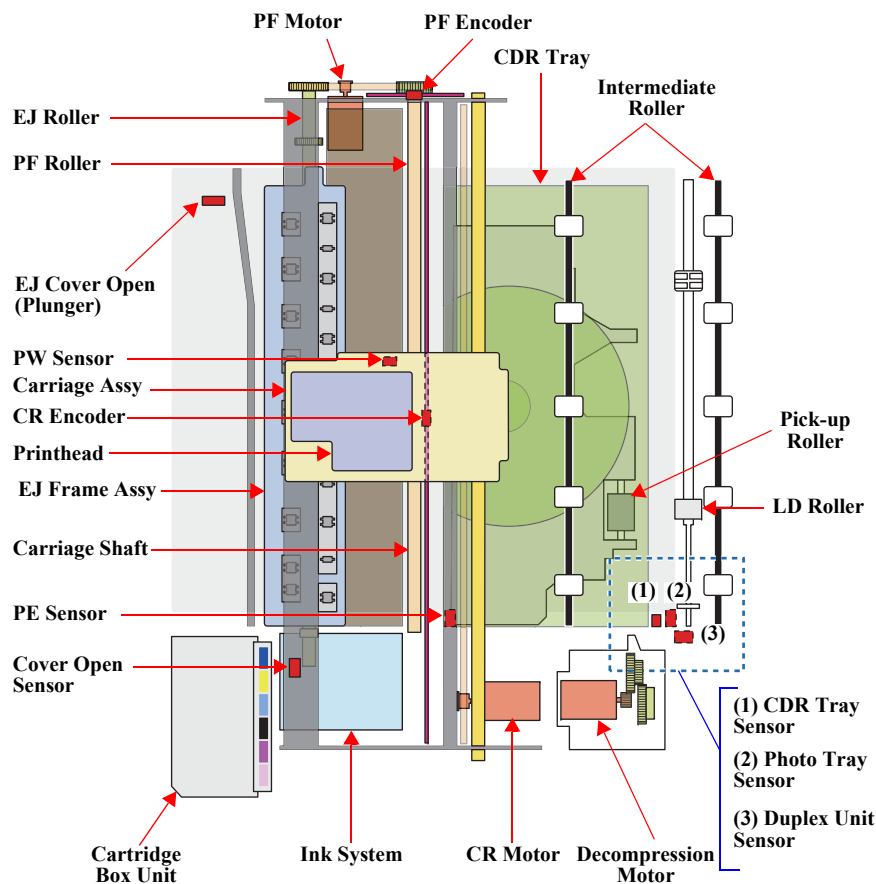


Figure 2-1. Printer Mechanism Block Diagram

2.1.3 Motors & Sensors

The following describes the motors and sensors.

Table 2-1. Motors & Sensors (Printer)

Name	Motors & Sensors name	#
Printhead		---
Carriage mechanism	CR Motor	A
	CR Encoder	1
	PW Sensor	2
Paper feeding mechanism	PF Motor	B
	PF Encoder	3
	PE Sensor	4
	CDR Tray Sensor	5
	EJ Cover Open (Plunger)	6
	Photo Tray Sensor	7
Ink Supply mechanism	Decompression Motor	C
Duplex Printing mechanism	Duplex Unit Sensor	8

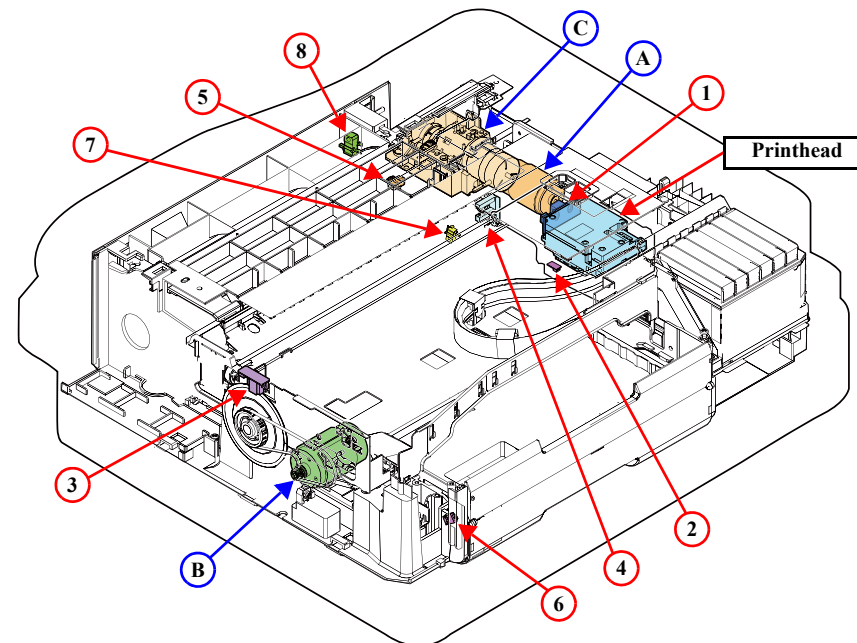


Figure 2-3. Motors & Sensors (Printer)

CHECK
POINT



See “3.2.1 Motor and Sensor Troubleshooting” (p.55) for the each motor and sensor specification.

Table 2-2. Motors & Sensors (Scanner)

Name	Motors & Sensors name	#
Scanner Carriage Unit		---
Open/close detection mechanism	Cover Open Sensor	9
Drive section of Scanner Carriage mechanism	Scanner Motor	D
	Scanner CR Encoder	10

Table 2-3. Motors & Sensors (ADF)

Name	Motors & Sensors name	#
Paper feeding mechanism	ADF Motor	E
	ADF DOC Sensor	11
	ADF PE Sensor	12



See “3.2.1 Motor and Sensor Troubleshooting” (p.55) for the each motor and sensor specification.

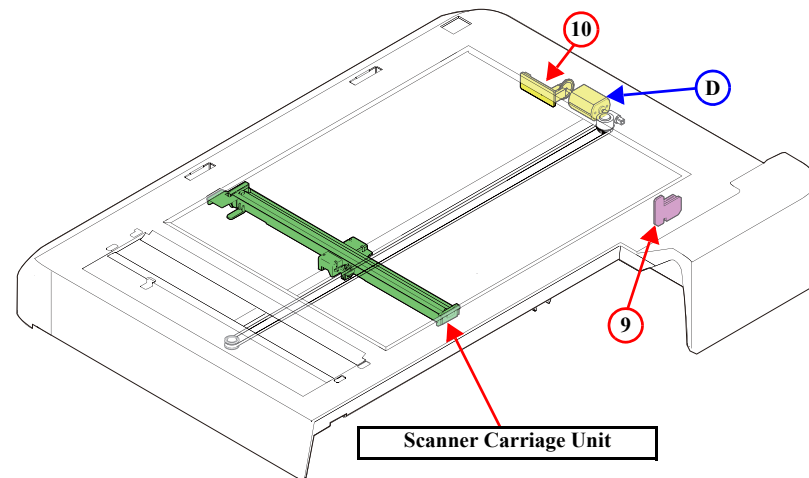


Figure 2-4. Motors & Sensors (Scanner)

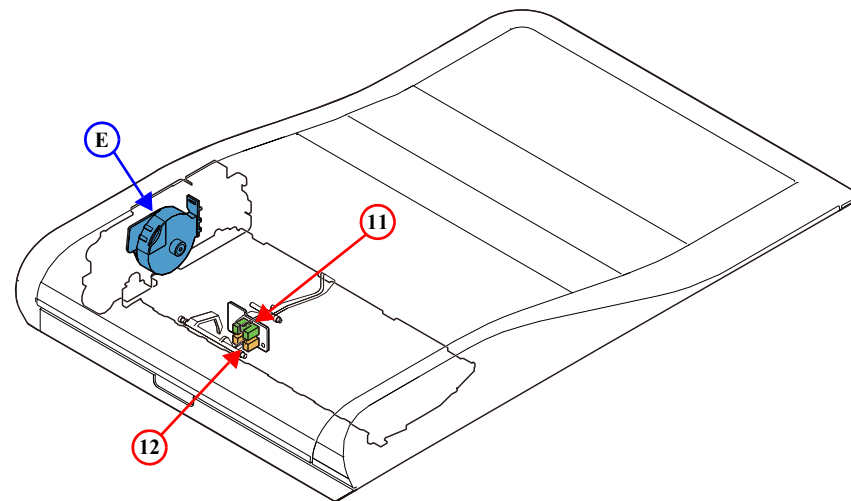


Figure 2-5. Motors & Sensors (ADF)

2.1.4 PG setting

Following is the PG setting for Epson Artisan 800/Epson Stylus Photo PX800FW/TX800FW/Epson Artisan 700/Epson Stylus Photo PX700W/TX700W.

Figure 2-6. PG positions/Cam

PG								
Type		Pos.1	→	Pos.2	→	Pos.3	→	Pos.4
PG measurement (mm)		PG (-)		PG (Typ)		PG (+)		PG (++)
Position name		Home position		Normal position		PG large position		PG max position
Description	Printing	EPSON brand paper		Plain paper printing Avoiding friction of PG (-)		Envelope printing Avoiding friction of PG (Typ)		CD/DVD
	Not printing	<input type="checkbox"/> Capping <input type="checkbox"/> Wiping <input type="checkbox"/> Ready position after initialization <input type="checkbox"/> AID		Capping		Capping		<input type="checkbox"/> Capping <input type="checkbox"/> EJ release
Rotating direction for PF Motor								

2.1.5 Printer Initialization

There are four kinds of initialization method, and the following explains each initialization

1. Hardware initialization
This printer is initialized when turning the printer power on, or printer recognized the cold-reset command (remote RS command).
When printer is initialized, the following actions are performed.
 - (a) Initializes printer mechanism
 - (b) Clears input data buffer
 - (c) Clears print buffer
 - (d) Sets default values
2. Operator initialization
Initialization when resetting the USB software, and the following are performed
 - (a) Clears input data buffer
 - (b) Clears print buffer
 - (c) Sets default values
3. Software initialization
The ESC@ command also initialize the printer.
When printer is initialized, the following actions are performed.
 - (a) Clears print buffer
 - (b) Sets default values
4. IEEE 1284.4 “rs” command initialization
The printer recognized the IEEE 1284.4 “rs” command.
When printer is initialized, the following action is performed.
 - Initialization when an error occurs.
 - (a) Initializes printer mechanism
 - (b) Clears input data buffer
 - (c) Clears print buffer
 - (d) Sets default values
 - Initialization in normal operation
 - (a) Clears input data buffer
 - (b) Clears print buffer
 - (c) Sets default values

CHAPTER

3

TROUBLESHOOTING

3.1 Overview

This chapter describes how to solve problems.



- Be careful to avoid electric shocks when checking the electrical circuit boards while the power is turned on.
- Touching an FET, transistor or heat sink with one hand while touching a metal part of the mechanism with the other hand could result in an electric shock, so carefully avoid this.
- After initial filling of ink has been repeated several times, immediate moving or tilting of the printer could result in leaking of ink that has not been completely absorbed by the Waste Ink Pad. When initial filling of ink has been repeated several times, check the ink remaining in the tip of the Waste Ink Tube and the waste ink not absorbed by the Waste Ink Pad before moving the printer.



- Disassembly and reassembly of parts is often required when identifying the causes of problems. The parts should be disassembled and re-assembled correctly while referring to “DISASSEMBLY/ASSEMBLY” (p.93) so that the operation and status of each check item can be correctly verified.
- Some individual part and units may require adjustment once they are removed or replaced. If removing or replacing parts which have specific instructions for adjustment included in “DISASSEMBLY/ASSEMBLY” (p.93), be sure to make these adjustments after repairing the problem location.

3.1.1 Specified Tools

This printer does not require any specified tools for troubleshooting.

3.1.2 Preliminary Checks

Before starting troubleshooting, be sure to verify that the following conditions are all met:

- The power supply voltage must be within the specification limits. (Measure the voltage at the wall socket.)
- The power code must be free from damage, short circuit or breakage, or miswiring in the power code.
- The printer must be grounded properly.
- The printer should not be located in a place where it can be exposed to too high or low temperature, too high or low humidity, or abrupt temperature change.
- The printer should not be located near waterworks, near humidifiers, near heaters or near flames, in a dusty atmosphere or in a place where the printer can be exposed to blast from an air conditioner.
- The printer should not be located in a place where volatile or inflammable gases are produced.
- The printer should not be located in a place where it can be exposed to direct rays of the sun.
- The printer must be placed on a strong and steady level table (without an inclination larger than five degrees).
- Any vibrating equipment must not be placed on or under the printer.
- The paper used must conform to the specification.
- There is no error in handling of the printer.
- Check the inside of the printer, and remove foreign matters if any, such as paper clips, staples, bits of paper, paper dust or toner.
- Clean the inside of the printer and the rubber rolls.

3.2 Troubleshooting

3.2.1 Motor and Sensor Troubleshooting



For the position of each sensor/motor, see 2.1.3 "Motors & Sensors" (p.49).

□ Motors

The resistance values for the CR motor and the PF motor are given below, however, the values cannot be used to check the motors status since they are DC motor and the resistance between the electric poles varies. Visually check the motors for abnormal operation and if it is hard to judge, replace the motor.

Table 3-1. Motor resistance and check point

Motor	Motor Type	Check point	Resistance
CR motor	DC motor with brush	Main Board: Pin1-Pin2 of CN21	19.7 Ω \pm 10 %
PF motor		Main Board: Pin1-Pin2 of CN22	19.7 Ω \pm 10 %
Decompression motor		Main Board: Pin1-Pin2 of CN24	88 Ω \pm 15 %
Scanner motor		Main Board: Pin1-Pin2 of CN49	(TBD) Ω \pm 10 %
ADF motor	4-phase, 96-pole PM stepping motor	Main Board: Pin1-Pin3, Pin2-Pin4 of CN25	28.0 Ω \pm 7 %/phase (25 °C)

□ Sensors

Table 3-2. Sensor check point

Sensor name	Check point	Signal level	Switch mode
PE Sensor (Transmissive photo interrupter)	Main Board: Pin1-Pin2 of CN9	Less than 0.4 V	No paper
		More than 2.4 V	Detects the paper
Scanner Cover Open Sensor (1) (GMR sensor)	Main Board: Pin1-Pin2 of CN10	Less than 0.4 V	Scanner Open
		More than 2.4 V	Scanner Closed
Scanner Cover Open Sensor (2) (GMR sensor)	Main Board: Pin2-Pin4 of CN10	Less than 0.4 V	Carriage: at HP
		More than 2.4 V	Carriage: at the origin position (where the carriage touches the right frame)
PW Sensor (Reflective photo interrupter)	Main Board: Pin1-Pin3 of CN6	0 V (for reference only)	No paper
		3.3 V (for reference only)	Detects the paper
Duplex Unit Sensor (Mechanical contact points)	Main Board: Pin1-Pin2 of CN13	Less than 0.4 V	Duplex Unit attached
		More than 2.4 V	No Duplex Unit
CDR Tray Sensor (Mechanical contact points)	Main Board: Pin1-Pin2 of CN14	Less than 0.4 V	Detects CDR Tray
		More than 2.4 V	No CDR Tray
Photo Tray Sensor (Mechanical contact points)	Main Board: Pin1-Pin2 of CN12	Less than 0.4 V	Photo Tray in use
		More than 2.4 V	Photo Tray retracted
EJ Cover Open Sensor (Electromagnetic plunger)	Main Board: Pin1-Pin2 of CN19	Conducting	Hold
		Breaking	Open

3.3 Troubleshooting by Error Message

This section explains about errors during each sequence/operation (power-on, paper feeding, ink sucking or the like), error/warning messages displayed on the LCD and their error causes.

3.3.1 Error Message List

The following table lists the error messages displayed on the LCD with their possible cause and reference page for troubleshooting. If the error or warning indication is not found in the table below, refer to the Users Guide and the displayed instructions, and carry out appropriate troubleshooting.

Table 3-3. Error Indications and Fault Occurrence Causes

Error Name	LCD Message	Error Cause	Reference
Fatal error (printer mechanism)	A printer error has occurred. Turn off the printer and turn it on again. See your documentation.	Mechanical trouble occurred.	Table 3-4. (p58)
Fatal error (paper jam)	It is likely that a paper jam has occurred in the printer. Turn off the printer, then open the scanner unit and remove the paper. See your documentation.		
Fatal error (Scanner)	A scanner error has occurred. See your documentation.		
Maintenance request (waste ink over flow)	The printer's ink pads are at the end of their service life. Please contact Epson support.	The waste ink counter exceeds to capacity.	Table 3-5. (p64)
Paper jam error	Paper jam. Open the scanner unit. Remove the jammed paper, close the scanner unit, then press the [Start] button.	Paper remained in the paper path after paper ejection.	Table 3-6. (p64)
Double feed error	Multi-page feed error. Remove and reload the paper, then press the [Start] button.	Double feeding occurred during double sided printing.	Table 3-7. (p65)
Paper out error	Paper out or paper jam in the main tray, or the paper size is incorrect. Check the paper size settings or clear the jam and press the [Start] button.	Failure to load paper to print.	Table 3-8. (p66)
Ink end error	You need to replace the following ink cartridge(s).	Ink is out in some I/C.	Table 3-9. (p67)
No ink cartridge error	Install the following ink cartridge(s).	I/C was not set.	
Incorrect ink cartridge	Cannot recognize the following ink cartridge(s). Install them correctly.	Incorrect I/C was set.	
Head cleaning (Ink low error)	Replace the following ink cartridge(s) before cleaning the print head.	Head cleaning was attempted in the Ink low status.	
Scanner open error	The scanner unit is open. When replacing ink cartridge(s), close the scanner unit after replacing the cartridge(s).	Scanner Unit was opened during printing.	Table 3-10. (p67)

Table 3-3. Error Indications and Fault Occurrence Causes

Error Name	LCD Message	Error Cause	Reference
Photo tray error	The paper cassette is not set correctly. Check for any objects in the cassette or blocking the cassette path and insert it correctly. Then press the [Start] button.	<ul style="list-style-type: none"> • Photo Tray cannot operate. • Cassette was not set. 	Table 3-11. (p68)
Incorrect CD size error	You can only print on 8 cm CD/DVDs by using a computer. Set a 12 cm CD/DVD.	One of the CD/DVD media other than 12 cm was set.	Table 3-12. (p68)
Remaining maintenance media error	Remove the CD/DVD from the tray to carry out maintenance, then press the [CD tray] button.	A medium on the CD/DVD tray was detected during cleaning or the like.	Table 3-13. (p69)
ADF paper jam error	Paper jam in the automatic document feeder. Remove the jammed paper.	Paper jam occurred in the ADF Unit.	Table 3-14. (p69)
Duplex Unit related error	---	<ul style="list-style-type: none"> • Duplex Unit cannot be detected. • Paper jam occurred in the Duplex Unit. 	"3.5 Troubleshooting Duplex Unit Problems" (p.78)
Network related error	---	A network related error occurred.	"3.6 Network Troubleshooting" (p.79)
FAX error (Epson Artisan 800/ Epson Stylus Photo PX800FW/ TX800FW/Epson Artisan 700/ Epson Stylus Photo PX700W/ TX700W)	---	A FAX error occurred.	"3.7 FAX Troubleshooting (Epson Artisan 800/ Epson Stylus Photo PX800FW/ TX800FW only)" (p.81)

3.3.2 Troubleshooting by Error Message

The following tables provide troubleshooting procedures. Confirm the error message displayed on the LCD, and verify it in the following list for the corresponding troubleshooting remedy. If some parts need to be replaced or repaired, make sure to follow the procedure given in Chapter 4 "DISASSEMBLY/ASSEMBLY".

Table 3-4. Check point for Fatal error according to each phenomenon (Printer Mechanism)

Occurrence Timing	Symptoms	Failed Part / Part Name	Check Point	Remedy	Reference
At power-on	The CR Motor does not operate at all.	CR Motor	1. Is the CR Motor cable properly connected to CN21 connector on the Main Board?	1. Connect the CR Motor cable correctly to CN21 connector on the Main Board.	4.2.3.2 " Main Board / Grounding Plate M/B " (p.117)
			2. Is the CR Motor cable damaged?	2. Replace the CR Motor with a new one.	4.2.4.15 " CR Motor " (p.152)
			3. Does the CR Motor operate normally?	3. Replace the CR Motor with a new one.	
	The Carriage Unit hits against the right side of the Main Frame.	CR Encoder	1. Is the CR Encoder damaged?	1. Replace the CR Encoder with a new one.	4.2.4.16 " Carriage Unit " (p.154)
			2. Is the FFC correctly connected to the connector on the CR Encoder?	2. Connect the Head FFC correctly.	
		CR Scale	1. Is the CR Scale properly centered in the slit of the CR Encoder?	1. Install the CR Scale correctly.	4.2.4.2 " CR Scale " (p.129)
			2. Is the CR Scale surface clean?	2. Wipe any dirt off the surface of the CR Scale. When the contamination is severe, replace the CR Scale with a new one.	
			3. Is the CR Scale damaged?	3. Replace the CR Scale with a new one.	
			4. Is the CR Scale correctly installed?	4. Install the CR Scale and the torsion spring correctly.	
		The Carriage Unit hits against the Upper Paper Guide.	Upper Paper Guide	1. Is the Upper Paper Guide correctly installed?	1. Install the Upper Paper Guide correctly.

Table 3-4. Check point for Fatal error according to each phenomenon (Printer Mechanism)

Occurrence Timing	Symptoms	Failed Part / Part Name	Check Point	Remedy	Reference	
At power-on	The Carriage Unit movement is too slow.	Carriage Shaft	1. Is the Carriage Shaft free from dirt, and adequately lubricated?	1. Clean the Carriage Shaft and lubricate it as specified.	4.2.4.16 " Carriage Unit " (p.154)	
		CR Guide Plate	1. Is the CR Guide Plate free from dirt, and adequately lubricated?	1. Clean the CR Guide Plate and lubricate it as specified.	4.2.4.20 " Waste Ink Tray Assy " (p.163)	
		Ink Tube	1. Is the Ink Tube correctly routed?	1. Route the Ink Tube correctly.	4.2.4.5 " Ink Supply IC Holder Assy " (p.133)	
		Head FFC	1. Is the Head FFC correctly routed?	1. Route the Head FFC correctly.	4.4 " Routing FFC/cables " (p.202)	
		---	1. Is the Carriage path contaminated with foreign material (slip of paper)?	1. Remove any foreign material from Carriage path.	---	
	The Carriage Unit makes abnormal noise during operation (Slipping of CR Timing belt)	CR Timing Belt, Timing Driven Pulley Assy	1. Is the CR Timing Belt correctly installed to Timing Driven Pulley Assy?	1. Install the Timing Driven Pulley Assy to CR Timing Belt correctly.	4.2.4.16 " Carriage Unit " (p.154)	
			2. Is the CR Timing Belt correctly installed to the Pinion Gear of the CR Motor?	2. Install CR Timing Belt correctly.		
	PF Motor does not operate at all.	CR Timing Belt, Driven Pulley Assy	1. Is tension of the CR Timing Belt appropriate?	1. Reassemble the CR Timing Belt and check the tension of the CR Timing Belt again. If the tension is still not appropriate, replace the Printer Mechanism.	<ul style="list-style-type: none"> • 4.2.4.16 " Carriage Unit " (p.154) • 5.3.2 " CR Timing Belt Tension Adjustment " (p.240) 	
			PF Motor	1. Is the PF Motor cable properly connected to CN22 connector on the Main Board?	1. Connect the PF Motor cable correctly to CN22 connector on the Main Board.	4.2.3.2 " Main Board / Grounding Plate M/B " (p.117)
				2. Is the PF Motor cable damaged?	2. Replace the PF Motor with a new one.	4.2.4.14 " PF Motor " (p.150)
	3. Does the PF Motor operate normally?	3. Replace the PF Motor with a new one.				
	CR lock is not released and a fatal error occurs	Main Board	1. Check if the firmware is the latest.	1. Update the firmware to the latest.	---	
		Ink System	1. Check if the CR lock lever moves smoothly.	1. Replace the Ink System with a new one.	4.2.4.6 " Ink System " (p.135)	

Table 3-4. Check point for Fatal error according to each phenomenon (Printer Mechanism)

Occurrence Timing	Symptoms	Failed Part / Part Name	Check Point	Remedy	Reference
At power-on	Cap does not move up or down and the Carriage Unit cannot move out of the home position.	Ink System	1. Check if the Ink System is installed evenly (horizontally).	1. Re-install the Ink System with the cap section horizontally.	4.2.4.6 " Ink System " (p.135)
			2. Check if the cap section of the Ink System works smoothly.	2. Replace the Ink System with a new one.	
	The PF Roller makes a quick turn and then the error occurs.	PF Encoder	1. Is the PF Encoder FFC correctly connected to CN8 connector on the Main Board and the connector on the PF Encoder?	1. Connect the PF Encoder FFC correctly to CN8 connector on the Main Board.	4.2.3.2 " Main Board / Grounding Plate M/B " (p.117)
			2. Is the PF Encoder correctly installed?	2. Install the PF Encoder correctly.	---
			3. Is the PF Encoder damaged?	3. Replace the printer mechanism with a new one.	---
		PF Scale	1. Is the PF Scale surface clean?	1. Wipe any dirt off the surface of the PF Scale. When the contamination is severe, replace the printer mechanism with a new one.	---
	2. Is the PF Scale damaged?		2. Replace the printer mechanism with a new one.		
	The PF Motor makes abnormal noise during operation (Slipping of PF Timing Belt)	PF Timing Belt, PF Tensioner	1. Is the PF Timing Belt damaged?	1. Replace the printer mechanism with a new one.	<ul style="list-style-type: none"> • 4.2.4.14 " PF Motor " (p.150) • 5.3.3 " PF Timing Belt Tension Adjustment " (p.241)
			2. Is the PF Timing Belt correctly installed to the PF Tensioner?	2. Install the PF Timing Belt to the PF Tensioner correctly.	
			3. Is the PF Timing Belt correctly installed to the PF Motor?	3. Install the PF Timing Belt correctly.	
4. Is tension of the PF Timing Belt appropriate?			4. Reassemble PF Timing Belt if the tension is not enough and check the tension of the PF Timing Belt again. If the tension is still not appropriate, replace the Printer Mechanism.		
The Carriage Unit hits the Changing Lever when it moves to the 0 digit side.	Paper Guide Front Assy	1. Does the Changing Lever correctly move?	1. Replace the Paper Guide Front Assy with a new one.	4.2.4.20 " Waste Ink Tray Assy " (p.163)	

Table 3-4. Check point for Fatal error according to each phenomenon (Printer Mechanism)

Occurrence Timing	Symptoms	Failed Part / Part Name	Check Point	Remedy	Reference
At power-on	The error occurs at power-on before carrying out the initial ink charge.	PW Sensor	1. Is the CR Encoder FFC correctly connected to CN6 connector on the Main Board?	1. Connect the CR Encoder FFC correctly to CN6 on the Main Board.	4.2.3.2 " Main Board / Grounding Plate M/B " (p.117)
			2. Is the CR Encoder damaged?	2. Replace the Head FFC with a new one.	4.2.4.16 " Carriage Unit " (p.154)
			3. Is the PW Sensor damaged?	3. Replace the Carriage Unit with a new one.	
	The error occurs after cleaning.	Ink System	1. Is the AID Cable correctly connected to the connector on the SUB Board?	1. Connect the AID Cable correctly to connector on the SUB Board.	4.2.4.6 " Ink System " (p.135)
			2. Is the AID Cable damaged?	2. Replace the Ink System with a new one.	
			3. Is the AID Cable correctly routed?	3. Route the AID Cable correctly.	
		SUB Board (AID)	1. Is the FFC connecting the SUB Board to CN7 on the Main Board connected correctly?	1. Connect the FFC correctly.	4.2.3.2 " Main Board / Grounding Plate M/B " (p.117)
			2. Is the FFC connecting the SUB Board to CN7 on the Main Board damaged?	2. Replace the FFC with a new one.	• 4.2.3.5 " Card Slot Assy " (p.123)
			3. Is SUB Board damaged?	3. Replace the Card Slot Assy with a new one.	• 4.3.2.3 " Card Slot Assy (Artisan 700/PX700W/ TX700W) " (p.199)
• At power-on • During CDR printing	EJ Frame Assy does not move.	EJ Frame Assy	1. Is EJ Frame Assy correctly installed?	1. Install the EJ Frame Assy correctly.	4.2.4.13 " EJ Frame Assy / EJ Release Frame Assy R/ EJ Release Frame Assy L " (p.147)
			2. Is the path of the EJ Frame Assy contaminated with foreign material (slip of paper)?	2. Remove any foreign material for EJ Frame path.	
			3. Is the EJ Frame Assy adequately lubricated?	3. Lubricate the EJ Frame Assy as specified.	
		Fixing Plate R	1. Check if the Fixing Plate R works correctly in conjunction with the PG cam.	1. Properly lubricate the slider section to the frame.	6.1.3 " Lubrication " (p.249)
		Front Paper Guide Assy	1. Check the lubrication status of EJ release trigger.	1. Wipe off the grease once, and lubricate the part with the specified amount of grease.	6.1.3 " Lubrication " (p.249)

Table 3-4. Check point for Fatal error according to each phenomenon (Printer Mechanism)

Occurrence Timing	Symptoms	Failed Part / Part Name	Check Point	Remedy	Reference
<ul style="list-style-type: none"> • At power-on • During CDR printing 	EJ Frame Assy does not move.	APG Assy	1. Check if the spur gears of the APG Assy are correctly attached with their phases aligned.	1. Align the phases and install the spur gears correctly.	<ul style="list-style-type: none"> • 4.2.4.15 " CR Motor " (p.152) • 4.2.4.16 " Carriage Unit " (p.154)
		PF Scale	1. Check if there is dirt or foreign material attached on the PF Scale.	1. Clean the PF Scale. If not improved much, replace the printer mechanism with a new one.	---
	CDR Tray is not retracted.	CDR Tray Assy	1. Are the dowels of the arms of the CDR Tray Assy correctly attached with the grooves of the CDR Guide/ Lower Paper Guide Assy?	1. Install the CDR Tray Assy correctly.	4.2.4.8 " CDR Tray Assy " (p.140)
			2. Check if the CDR Tray Assy or the arms of the CDR Tray Assy warps.	2. Replace the CDR Tray Assy with a new one.	
		Spur Gear	1. Is the Spur Gear correctly installed?	1. Install the Spur Gear correctly.	
	CDR Guide Base Assy	1. Check the lubrication status of CDR Guide Base Assy.	1. Wipe off the grease once, and lubricate the part with the specified amount of grease.	6.1.3 " Lubrication " (p.249)	
The error occurs when PF Motor is still operating after CDR Tray was retracted.	CDR Tray Sensor	1. Is the CDR Tray Sensor cable properly connected to CN14 connector on the Main Board?	1. Connect the CDR Tray Sensor cable to CN14 on the Main Board.	4.2.3.2 " Main Board / Grounding Plate M/B " (p.117)	
		2. Is the CDR Tray Sensor cable damaged?	2. Replace the printer mechanism with a new one.	4.2.4.8 " CDR Tray Assy " (p.140)	
		3. Is the CDR Tray Sensor damaged?	3. Replace the printer mechanism with a new one.		
<ul style="list-style-type: none"> • At power-on • Changing PG position 	The error occurs when the platen gap is automatically changed.	APG Assy	1. Are the phases of the Spur Gears of the APG Assy correct?	1. Align the phases and install the spur gears correctly.	<ul style="list-style-type: none"> • 4.2.4.15 " CR Motor " (p.152) • 4.2.4.16 " Carriage Unit " (p.154)
<ul style="list-style-type: none"> • Before printing • Cleaning 	The error occurs before printing or cleaning.	Print Head	1. Is the Print Head damaged?	1. Replace the Print Head with a new one.	4.2.4.1 " Printhead " (p.124)
		Head FFC	1. Is the Head FFC correctly connected to CN1, CN2, CN3 and CN4 on the Main Board?	1. Replace the Head FFC with a new one.	
			2. Is the Head FC damaged?	2. Replace the Head FFC with a new one.	

Table 3-4. Check point for Fatal error according to each phenomenon (Printer Mechanism)


Occurrence Timing	Symptoms	Failed Part / Part Name	Check Point	Remedy	Reference
---	Others	Main Board	1. Is the Main Board damaged?	1. Replace the Main Board with a new one.	4.2.3.2 " Main Board / Grounding Plate M/B " (p.117)
		---	1. Check if the CR Stopper is blocking the printer operation because it has fallen into the mechanism. 	1. Remove the CR Stopper.	<ul style="list-style-type: none"> • 4.1.3 " Work Completion Check " (p.95) • 4.2.2.5 " Upper Housing " (p.107)

Table 3-5. Check point for Fatal error according to each phenomenon (Scanner)

Occurrence Timing	Symptoms	Failed Part / Part Name	Check Point	Remedy	Reference
At power-on	The Scanner Unit does not initialize at power-on.	Scanner Motor	1. Is the Scanner Motor cable properly connected to CN49 connector on the Main Board?	1. Connect the Scanner Motor cable correctly to CN49 connector on the Main Board.	4.2.5.2 " Scanner Motor Unit " (p.168)
			2. Is the coil resistance of the Scanner Motor TBD Ω Check with the tester. (See Table 3-1)	2. Replace the Scanner Motor cable with a new one.	
			3. Is the Scanner Motor Cable damaged?	3. Replace the Scanner Motor cable with a new one.	
		Scanner CR Encoder	1. Is the Scanner CR Encoder FFC properly connected to CN49 connector on the Main Board?	1. Connect the Scanner CR Encoder FFC correctly to CN49 connector on the Main Board.	4.2.5.4 " Scanner CR Encoder Board " (p.172)
			2. Is the Scanner CR Encoder FFC damaged?	2. Replace the Scanner CR Encoder FFC with a new one.	
		Scanner Carriage FFC	1. Is the Scanner Carriage FFC properly connected to CN41 connector on the Main Board?	1. Connect the Scanner Carriage FFC correctly to CN41 connector on the Main Board.	4.2.5.3 " Scanner Carriage Unit " (p.169)
			2. Is the Scanner Carriage FFC damaged?	2. Replace the Scanner Carriage FFC with a new one.	
		Scanner Carriage Unit	1. Is the Scanner Carriage Unit damaged?	1. Replace the Scanner Carriage FFC with a new one.	

Table 3-6. Check point for the Maintenance request according to each phenomenon

Occurrence Timing	Symptoms	Failed Part / Part Name	Check Point	Remedy	Reference
Any time	The Maintenance error is displayed.	Waste Ink Tray Assy/ Lower Paper Guide Waste Ink Pad Assy	---	Replace Waste Ink Tray Assy or/and Lower Paper Guide Waste Ink Pad Assy and reset the waste ink counter.	<ul style="list-style-type: none"> 4.2.4.20 " Waste Ink Tray Assy " (p.163) 4.2.4.21 " Lower Paper Guide Waste Ink Pad Assy " (p.165)

Table 3-7. Check point for Paper jam error according to each phenomenon

Occurrence Timing	Symptoms	Failed Part / Part Name	Check Point	Remedy	Reference
Any time	Paper feeding operation is performed normally, but the paper is not fed inside the printer.	Rear Paper Guide Assy	1. Is Rear Paper Guide Assy correctly installed?	1. Install the Rear Paper Guide Assy correctly.	4.2.4.9 "LD Roller" (p.142)
		Lower ASF Paper Guide Assy	1. Is Lower ASF Paper Guide Assy correctly installed?	1. Install the Lower ASF Paper Guide Assy correctly.	4.2.4.7 "Lower ASF Paper Guide Assy" (p.138)
			2. Is the intermediate roller shaft correctly installed?	2. Install the intermediate roller shaft correctly.	
			3. Is the surface of intermediate roller contaminated with micro pearl paper dust or greasy dirt?	3. Clean the intermediate roller.	
			4. Does the flap of the Lower ASF Paper Guide Assy come off?	4. Install the flap of the Lower ASF Paper Guide correctly.	
		LD Roller	1. Is LD Roller shaft correctly installed?	1. Install the LD Roller shaft correctly.	4.2.4.9 "LD Roller" (p.142)
			2. Is the surface of LD Roller contaminated with micro pearl paper dust or greasy dirt?	2. Clean the LD Roller.	
	Paper Guide Top Assy	1. Is the Paper Guide Top Assy correctly installed?	1. Install the Paper Guide Top Assy correctly.	4.2.2.13 "Paper Guide Top Assy" (p.115)	
	Upper Paper Guide L/R Assy	1. Is the Upper Paper Guide L/R Assy correctly installed?	1. Install the Upper Paper Guide L/R Assy correctly.	4.2.4.19 "Upper Paper Guide L/R / PE Sensor" (p.161)	
	Multiple sheets of paper are always fed at one time.	Cassette Unit	1. Is the Cassette Cork damaged or worn?	1. Replace the Cassette Cork with a new one.	4.2.2.12 "Cassette Unit" (p.114)
2. Is the rear end of the Cassette Assy damaged?			2. Replace the Cassette Unit with a new one.		
Sub Transmission Cam Holder		1. Is the Sub Transmission Cam Holder correctly installed?	1. Install the Sub Transmission Cam Holder correctly.	4.2.4.19 "Upper Paper Guide L/R / PE Sensor" (p.161)	

Table 3-7. Check point for Paper jam error according to each phenomenon

Occurrence Timing	Symptoms	Failed Part / Part Name	Check Point	Remedy	Reference
Any time	Leading edge of paper does not go through between the EJ Roller and the Star Wheels.	EJ Frame Assy	1. Is the Star Wheel Roller Holder disengaged?	1. Install the Star Wheel Holder correctly.	4.2.4.13 " EJ Frame Assy / EJ Release Frame Assy R/ EJ Release Frame Assy L " (p.147)
			2. Is the EJ Frame Assy correctly installed?	2. Install the EJ Frame Assy correctly.	
			3. Is there any abnormality on the drive section of EJ Frame Assy?	3. Assemble the EJ Frame Assy correctly.	
			4. Is the EJ Frame Assy deformed protruding downward?	4. Replace the EJ Frame Assy with a new one.	
	Feeding is unstable, and paper jam error occurs.	Upper Paper Guide L/R Assy	1. Check if the torsion springs; two kinds securing the Upper Paper Guide L/R Assy, are correctly installed.	1. Install the torsion springs securing the Upper Paper Guide L/R Assy correctly.	4.2.4.19 " Upper Paper Guide L/R / PE Sensor " (p.161)
			2. Check if the attachment direction of the roller of Upper Paper Guide R Assy is correct.	2. Install the roller of Upper Paper Guide R Assy correctly.	

Table 3-8. Check point for the Paper Out Error according to each phenomenon

Occurrence Timing	Symptoms	Failed Part / Part Name	Check Point	Remedy	Reference
Any time	The LD Roller rotates normally, but paper is not fed.	LD Roller	1. Is the surface of LD Roller contaminated with micro pearl paper dust or greasy dirt?	1. Clean the LD Roller.	4.2.4.9 " LD Roller " (p.142)
	The intermediate roller rotates normally, but paper is not fed.	Intermediate roller	1. Is the surface of intermediate roller contaminated with micro pearl paper dust or greasy dirt?	1. Clean the intermediate roller.	4.2.4.7 " Lower ASF Paper Guide Assy " (p.138)
	The Pick-up Roller rotates normally, but the paper is not fed into the printer.	Pick-up Assy	1. Is the surface of Pick-up Rollers contaminated with micro pearl paper dust or greasy dirt?	1. Clean the Pick-up Roller.	4.2.4.10 " Pick-up Roller " (p.143)
	The PF Motor drive force is not transmitted to the LD Roller.	Frame Assy L	1. Is the clutch of the Frame Assy L damaged?	1. Replace the printer mechanism with a new one.	4.2.4.13 " EJ Frame Assy / EJ Release Frame Assy R/ EJ Release Frame Assy L " (p.147)
	The PF Motor drive force is not transmitted to the Pick-up Roller.	Frame Assy R	1. Is the clutch of the Frame Assy R damaged?	1. Replace the printer mechanism with a new one.	

Table 3-8. Check point for the Paper Out Error according to each phenomenon

Occurrence Timing	Symptoms	Failed Part / Part Name	Check Point	Remedy	Reference
Any time	Paper is ejected just after paper is fed.	PE Sensor	1. Is the connector cable of the PE Sensor properly connected to CN9 connector on the Main Board?	1. Connect the connector cable of the PE Sensor correctly to CN9 connector on the Main Board.	4.2.4.19 " Upper Paper Guide L/R / PE Sensor " (p.161)
			2. Is the PE Sensor damaged?	2. Replace Front Paper Guide Assy with a new one.	
		Upper Paper Guide R	1. Is the lumiler protecting the PE Sensor contaminated?	1. Replace Upper Paper Guide Assy with a new one.	

Table 3-9. Check point for the Ink End Error / No Ink Cartridge Error / Incorrect Ink Cartridge Error according to each phenomenon

Occurrence Timing	Symptoms	Failed Part / Part Name	Check Point	Remedy	Reference
At power-on	The error occurs after the carriage detected the home position.	Ink Cartridge	1. Is the Memory chip on the Ink Cartridge disconnected or damaged?	1. Replace the Ink Cartridge with a new one.	---
		CSIC FFC	1. Is the CSIC FFC properly connected to CN5 connector on the Main Board and the connector on the CSIC Assy?	1. Connect the CSIC FFC correctly.	4.2.4.4 " CSIC Assy " (p.132)
		CSIC Assy	1. Is the CSIC terminal damaged?	1. Replace the CSIC Assy with a new one.	4.2.4.4 " CSIC Assy " (p.132)
2. Is the CR contact module damaged?	2. Replace the CSIC Assy with a new one.				

Table 3-10. Check point for the Scanner Open Error according to each phenomenon

Occurrence Timing	Symptoms	Failed Part / Part Name	Check Point	Remedy	Reference	
Any time	The Printer Cover is closed, but the cover open error is displayed.	Scanner Cover Open Sensor FFC	1. Is the Scanner Cover Open Sensor FFC properly connected to CN10 connector on the Main Board?	1. Replace the Scanner Unit with a new one.	<ul style="list-style-type: none"> • 4.2.5 " Disassembling Scanner Unit " (p.167) • 4.3.3 " Disassembling the Scanner Unit (Artisan 700/PX700W/TX700W) " (p.200) 	
			2. Is the Scanner Cover Open Sensor FFC damaged?	2. Replace the Scanner Unit with a new one.		
		Scanner Cover Open Sensor	1. Is the Scanner Cover Open Sensor damaged?	1. Replace the Scanner Unit with a new one.		
		Carriage Unit	1. Is the Sensor magnet of the Carriage Unit damaged?	1. Replace the Carriage Unit with a new one.		4.2.5.3 " Scanner Carriage Unit " (p.169)
		Upper Housing	1. Is the Open Sensor magnet of the Upper Housing damaged?	1. Replace the Upper Housing with a new one.		4.2.2.5 " Upper Housing " (p.107)

Table 3-11. Check point for the Photo Tray Error according to each phenomenon

Occurrence Timing	Symptoms	Failed Part / Part Name	Check Point	Remedy	Reference
Any time	Photo Tray does not move at all.	Cassette	1. Is the Cassette Unit correctly installed?	1. Install Cassette Unit correctly.	4.2.2.12 " Cassette Unit " (p.114)
			2. Is the Cassette Unit damaged?	2. Replace the Cassette Unit with a new one.	
		Photo Tray Sensor	1. Is the Photo Tray Sensor cable properly connected to CN12 connector on the Main Board?	1. Connect the Photo Tray Sensor cable correctly to CN12 on the Main Board.	4.2.3.2 " Main Board / Grounding Plate M/B " (p.117)
			2. Is Photo Tray Sensor cable damaged?	2. Replace the printer mechanism with a new one	---
			3. Is Photo Tray Sensor damaged?	3. Replace the printer mechanism with a new one	

Table 3-12. Check point for the CD size Error according to each phenomenon

Occurrence Timing	Symptoms	Failed Part / Part Name	Check Point	Remedy	Reference
Any time	The error occurs even the 12cm CD/DVD is on the CDR Tray.	PW Sensor	1. Is the PW Sensor free from ink stain or paper dust?	1. Clean the surface of the PW Sensor.	4.2.4.16 " Carriage Unit " (p.154)
			2. Is the PW Sensor connector cable properly connected to the connector of the PW Sensor and CR Encoder board?	2. Connect the PW Sensor connector cable correctly.	
			3. Is the PW Sensor connector cable damaged?	3. Replace the Carriage Unit with a new one.	
			4. Is the PW Sensor damaged?	4. Replace the Carriage Unit with a new one.	
		CDR Tray	1. Is the white marking of the CDR Tray free from ink stain or paper dust?	1. Clean the marking of the CDR Tray.	4.2.4.8 " CDR Tray Assy " (p.140)
			2. Is CDR Tray correctly installed?	2. Install the CDR Tray correctly.	

Table 3-13. Check point for the Maintenance Media Error according to each phenomenon

Occurrence Timing	Symptoms	Failed Part / Part Name	Check Point	Remedy	Reference
Any time	The error occurs even the 12cm CD/DVD is on the CDR Tray.	PW Sensor	1. Is the PW Sensor free from ink stain or paper dust?	1. Clean the surface of the PW Sensor.	4.2.4.16 " Carriage Unit " (p.154)
			2. Is the PW Sensor connector cable properly connected to the connector of the PW Sensor and CR Encoder board?	2. Connect the PW Sensor connector cable correctly.	
			3. Is the PW Sensor connector Cable damaged?	3. Replace the Carriage Unit with a new one.	
			4. Is the PW Sensor damaged?	4. Replace the Carriage Unit with a new one.	
		CDR Tray	1. Is the white marking of the CDR Tray free from ink stain or paper dust?	1. Clean the marking of the CDR Tray.	4.2.4.8 " CDR Tray Assy " (p.140)
			2. Is CDR Tray correctly installed?	2. Install CDR Tray correctly.	

Table 3-14. Check point for the ADF Paper Jam Error according to each phenomenon

Occurrence Timing	Symptoms	Failed Part / Part Name	Check Point	Remedy	Reference
At power-on	The error displays on the LCD after initialization at power-on.	ADF Cover Assy	1. Is the ADF Cover Assy closed?	1. Close the ADF Cover Assy.	4.2.6.2 " ADF Cover Assy/ ADF Cover L " (p.175)
Any time	The sheet is fed in the ADF Unit, but reading does not start, the error is displayed instead.	ADF PE Sensor	1. Is the ADF Sensor Cable properly connected to CN51 on the Main Board?	1. Connect the ADF sensor cable to CN51 on the Main Board correctly.	4.2.3.2 " Main Board / Grounding Plate M/B " (p.117)
			2. Is the ADF Sensor Cable damaged?	2. Replace the ADF Frame Assy with a new one.	4.2.6.8 " ADF Frame Unit " (p.180)
		ADF PE Sensor Lever	1. Is the ADF Sensor Lever deformed?	1. Replace the ADF Frame Assy with a new one.	4.2.6.8 " ADF Frame Unit " (p.180)
		ADF PF Roller	1. Is the Spur Gear 6.4 correctly installed to ADF PF Roller?	1. Install the Spur Gear 6.4 correctly.	4.2.6.10 " ADF PF Roller " (p.183)

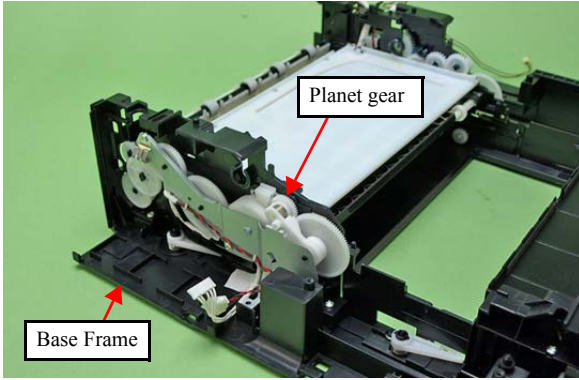
3.4 Troubleshooting without Error Message

3.4.1 Troubleshooting Printer Mechanism Problems

This section provides information for troubleshooting problems of printing mechanisms.

Abnormal Noises

Table 3-15. Troubleshooting Abnormal Noise Problems

Problem	Possible Cause	Check point	Remedy
When feeding Matt paper or the like, abnormal noise is generated in the rear left of the printer.	Engagement of the planet gear in the rear left of the Base Frame is incorrect.	<p>Check if the noise comes from the planet gear.</p>  <p>The diagram shows the internal mechanism of the printer. A red arrow points to a gear labeled 'Planet gear' which is meshed with other gears. Another red arrow points to the 'Base Frame' which houses the mechanism. The background is a light green color.</p>	Replace the printer mechanism with a new one

Paper feed error

Table 3-16. Troubleshooting Paper Feed Problems

Problem	Possible Cause	Check point	Remedy
Paper is not fed.	Paper Guide Top Assy installation error	Is the Paper Guide Top Assy correctly installed?	Install the Paper Guide Top Assy correctly. (See 4.2.2.13 " Paper Guide Top Assy " (p.115).)
	Contamination or wear of the Pick-up Roller, intermediate rollers, LD Roller	Is the surface of each Rollers contaminated with micro pearl paper dust or greasy dirt?	<p>Wipe and clean the rollers with a cleaning sheet.</p> <ol style="list-style-type: none"> 1. Attach the cleaning sheet to the Cassette Unit with a face down. 2. Operate a copy without a sheet on the Scanner. 3. Repeat it several times.
	Damage or wear of the cork of the Cassette Unit	Is the Cassette Cork damaged or worn?	Replace the cork of the Cassette Unit with a new one. (See 4.2.2.12 " Cassette Unit " (p.114).)
	Abnormal operation of the paper feed mechanism	Is there any abnormality found in the paper feed mechanism?	<ul style="list-style-type: none"> • Install them correctly if there is any abnormality found. • Remove dust if any.

Paper ejection error

Table 3-17. Troubleshooting Paper Ejecting Problems

Problem	Possible Cause	Check point	Remedy
Paper get jammed before being ejected	Paper feed operation failure	Does the PF Roller rotate normally and is the rotational force transmitted to the EJ Roller correctly?	Install the PF Motor properly and apply proper tension to the PF Timing Belt. (See 4.2.4.14 " PF Motor " (p.150), 5.3.3 " PF Timing Belt Tension Adjustment " (p.241).)
	EJ Roller operation failure	Does the EJ Roller rotate normally?	
	EJ Frame operation failure	Does the EJ Frame move normally?	
The CDR Tray does not come out.	CDR Tray operation failure	Are the dowels of the arms of the CDR Tray Assy correctly attached with the grooves of the CDR Guide Base Assy/ Lower Paper Guide Assy?	Install CDR Tray Assy correctly. (See 4.2.4.8 " CDR Tray Assy " (p.140).)
Paper ejected with the cover closed.	Electromagnetic plunger failure	Is the Electromagnetic plunger connected correctly to the Main Board?	Replace the printer mechanism if there is no connection error found. (See 4.2.3.2 " Main Board / Grounding Plate M/B " (p.117))

 Carriage error

Table 3-18. Troubleshooting Carriage Movement Problems

Problem	Possible Cause	Check point	Remedy
The movements of Carriage Unit during printing is abnormal	Something is obstructing the Carriage movements.	Is there any obstructions on the Carriage path?	Remove the obstructions. (See 4.2.4.16 " Carriage Unit " (p.154).)
		Does the Carriage Unit move smoothly when it is manually moved?	Clean the Carriage Shaft/CR Guide Plate and lubricate it as specified. (See 6.1.3 " Lubrication " (p.249).)
		Does the Head FFC have an adequate slack and not interrupting the Carriage movement? Check the FFC status by manually moving the Carriage Unit from side to side.	Route the Head FFC correctly on the Main Frame. (See 4.2.4.12 " Front Frame " (p.147), 4.4 " Routing FFC/cables " (p.202).)
		Is the routing of the Ink Supply Tube Assy correct? Check it and smoothness by manually moving the Carriage Unit from side to side to both ends.	Route the Ink Supply Tube Assy. (See 4.2.4.5 " Ink Supply IC Holder Assy " (p.133).)
		Is the CR Guide Plate correctly installed?	Install the CR Guide Plate correctly. (See 4.2.4.20 " Waste Ink Tray Assy " (p.163).)
		Is the PG adjustment appropriate?	Carry out the PG adjustment again. (See 5.3.1 " PG Adjustment " (p.235).)
		Is the tension of the CR Timing Belt appropriate?	Carry out the CR belt tension adjustment. If it is still not appropriate, replace the Printer mechanism with a new one. (See 5.3.2 " CR Timing Belt Tension Adjustment " (p.240).)

- Print quality problems

Table 3-19. Troubleshooting Print Quality Problems

Problem	Possible Cause	Check point	Remedy
Certain dots are always not printed correctly	Contamination of the Printhead surface (dots are missing)	Run a cleaning and make a test print. Repeat it several times.	Clean the Printhead surface using a cotton-tipped swab.
	The capping absorber contacts with the Printhead surface.	Is the capping absorber deformed or damaged?	Replace the Ink System with a new one. (See 4.2.4.6 " Ink System " (p.135).)
	Head FFC failure	Is the Head FFC damaged?	Check if the Head FFC is damaged. (See 4.2.4.1 " Printhead " (p.124), 4.2.4.16 " Carriage Unit " (p.154).)
	Printhead failure	Run a cleaning and nozzle check. Repeat it several times.	If the cleaning does not solve the problem, replace the Printhead with a new one. (See 4.2.4.1 " Printhead " (p.124).)
Dots are sometimes missing	Contamination of the Printhead surface (dots are missing)	Run a cleaning and nozzle check. Repeat it several times.	Clean the Printhead surface using a cotton-tipped swab.
	Ink cartridge failure	Replace the ink cartridges with new ones, and run a nozzle check.	Replace the Ink cartridges with new ones.
	Poor connection of the Head FFC	Check the FFC using a tester. Does the result show abnormality?	Replace the Head FFC with a new one. (See 4.2.4.1 " Printhead " (p.124), 4.2.4.16 " Carriage Unit " (p.154).)
	Printhead failure	Run a cleaning several times, and then run a nozzle check.	If the cleaning does not solve the problem, replace the Printhead with a new one. (See 4.2.4.1 " Printhead " (p.124).)
Printout is totally abnormal	Poor connection of the Head FFC	Is the FFC securely connected to the boards and Carriage Unit?	Connect the Head FFC correctly.
	Printhead failure	Is the Head FFC securely connected to the Printhead?	If no problem is found in the connection, replace the Printhead with a new one. (See 4.2.4.1 " Printhead " (p.124).)
Vertical lines are not straight	Improper Bi-D adjustment	Has the Bi-D adjustment been carried out properly?	Carry out the Bi-D adjustment. (See 5.2 " Adjustment Using Adjustment Program " (p.219).)
Ink mist is attached on the paper.	Anti static cloth on the rear frame is deformed.	Check if the anti static cloth is correctly formed to touch the paper.	Attach the anti static cloth again so as to let it touch the paper. If not improved much, replace the printer mechanism with a new one. (See 4.2.4.18 " Rear Frame " (p.159).)

Table 3-19. Troubleshooting Print Quality Problems

Problem	Possible Cause	Check point	Remedy
White bands appear on printouts	Contamination of the Carriage Shaft	Is the Carriage Shaft free from dirt?	Clean the Carriage Shaft surface with a soft dry cloth.
	Contamination of the CR Guide Plate	Is the CR Guide Plate free from dirt?	Clean the CR Guide Plate surface with a soft dry cloth.
	PF Roller failure	Is the PF Roller free from dirt?	Carefully clean the PF Roller surface with a soft brush.
		Is the PF Roller damaged?	Replace the PF Roller with a new one. (See 4.2.4.1 " Printhead " (p.124).)
	Ink cartridge failure	Set new ink cartridges and make a test print. The problem does not occur?	Replace the Ink cartridges with new ones.
	Sliding operation failure of the Carriage	Is the backside of the Main Frame where the Carriage slides against adequately lubricated?	Clean the Main Frame and apply G-71 grease as specified. (See 6.1.3 " Lubrication " (p.249).)
	Improper platen gap	Is the platen gap setting correct?	Carry out the PG adjustment. (See 5.3.1 " PG Adjustment " (p.235).)
	Damage of gears	Are the gears of the PF and ASF mechanisms free from damage or deformation?	Replace the faulty part with a new one.
	Due to contamination on the Printhead surface, ink droplets are fired diagonally.	Run a cleaning and make a test print. Repeat it several times.	Clean the Printhead surface using a cotton-tipped swab.
		Is the Head Cleaner free from dust or dirt?	Clean the Head Cleaner or replace it with a new one. (See 4.2.4.6 " Ink System " (p.135).)
	Printhead failure	Run a cleaning several times, and then make a test print.	Replace the Printhead with a new one. (See 4.2.4.1 " Printhead " (p.124).)
	Carriage Shaft failure	Is the Carriage Shaft correctly installed?	Reassemble the Carriage Shaft. (See 4.2.4.16 " Carriage Unit " (p.154).)
Is the Carriage Shaft surface damaged?		Replace the Carriage Shaft with a new one. (See 4.2.4.16 " Carriage Unit " (p.154).)	

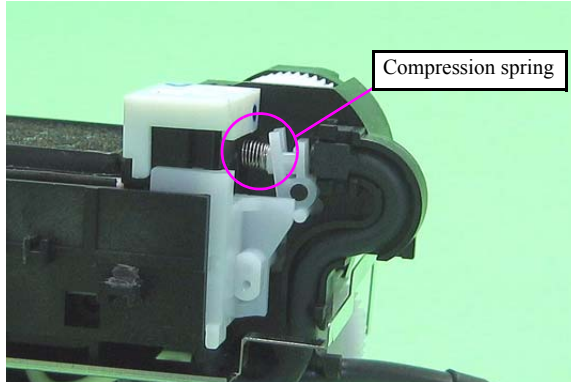
- Ink is not supplied properly

Table 3-20. Troubleshooting Ink Supply Problems

Problem	Possible Cause	Check point	Remedy
The carriage moves correctly, but the printout is abnormal	Ink cartridge failure	Set new ink cartridges and make a test print. The problem does not occur?	Replace the Ink cartridges with new ones.
	Incorrect connection of the Head FFC	Is the Head FFC properly connected to the Printhead and CN1, CN2, CN3 and CN4 connectors on the Main Board?	Connect the Head FFC correctly. (See 4.2.4.1 "Printhead" (p.124) .)
	Head Cleaner failure	Is the Head Cleaner free from dust or dirt?	Clean the Head Cleaner or replace it with a new one. (See 4.2.4.6 "Ink System" (p.135) .)
	Poor connection of the Head FFC	Check the FFC using a tester. Does the result show abnormality?	Replace the Head FFC with a new one. (See 4.2.4.1 "Printhead" (p.124) , 4.2.4.16 "Carriage Unit" (p.154) .)
	Printhead failure	Run a cleaning and make a test print. Repeat it several times.	If the cleaning does not solve the problem, replace the Printhead with a new one. (See 4.2.4.1 "Printhead" (p.124) .)
	Ink leak or clogging	Is ink leakage observed on the Printhead/Cartridge Box Unit?	Install the ink cartridges correctly. If this does not solve the problem, replace the ink cartridges with new ones.
		Is the Ink Supply Tube Assy properly connected to the Printhead and Cartridge Box Unit?	Connect Ink Supply Tube Assy to the Printhead and Cartridge Box Unit correctly. If the problem is not solved, replace the Printhead, or Ink Supply Tube Assy/Cartridge Box Unit with new ones. (See 4.2.4.1 "Printhead" (p.124) , 4.2.4.5 "Ink Supply IC Holder Assy" (p.133) .)
Is the Decompression Tube properly connected to the Cartridge Box Unit?		If no problem is found in the connection, replace the Decompression Tube with a new one. (See 4.2.4.3 "Decompression Pump Unit" (p.130) .)	

Waste ink error

Table 3-21. Troubleshooting Waste Ink Problems

Problem	Possible Cause	Check point	Remedy
Ink is not properly transported from the Printhead to the cap, or from the cap to the Ink Tubes.	The pump tube is partially compressed.	Is there any flat portions in the tubes?	Replace the Ink System with a new one. (See 4.2.4.6 " Ink System " (p.135).)
	Contamination or damage of the cap.	Is the Cap damaged or contaminated with foreign material?	Remove any foreign material using a cotton bud, or replace the Ink System with a new one if any damage is observed. (See 4.2.4.6 " Ink System " (p.135).)
	Disconnection of the Ink Tube from the cap.	Is the tube properly connected to the lower part of the Cap?	Connect the tubes correctly. (See 4.2.4.6 " Ink System " (p.135).)
	Cap movement failure	Is the compression spring of the cap section properly engaged?	Replace the Ink System with a new one. (See 4.2.4.6 " Ink System " (p.135).)
	The tube between the Waste Ink Tray Assy and the Ink System is partially flat.	Is the tube properly routed between the Waste Ink Tray Assy and the Ink System?	Securely connect the tube of the Waste Ink Pads and route the tube correctly. (See 4.2.4.6 " Ink System " (p.135).)
	Valve failure	Is the compression spring of the valve section properly engaged? 	Attach the compression spring correctly. If it is not improved, replace the Ink System with a new one. (See 4.2.4.6 " Ink System " (p.135).)

3.4.2 Troubleshooting Electrical Problems

Check the points described in the table below when the printer does not operate at all (LED does not light) at power-on.

Table 3-22. Troubleshooting Power Supply Problems

Problem	Check Point	Remedy
Power code failure	Replace the power code with another one, and check whether the printer is normally powered or not.	Replace the power code with a new one.
Incorrect AC power supply	Does the AC power source match with the requirement of the printer?	Use the correct power source.
Poor connection of the connectors	Is the Power Supply Unit Cable properly connected to CN501 connector on the Main Board?	Connect the cable correctly.
The fuse is blown	Is the fuse (F1) on the Power Supply Board blown?	Replace the Power Supply Board.
Abnormal output of the Power Supply Board	Is a normal voltage being output from the Power Supply Board?	Replace the Main Board when the output voltage is normal. Replace the Power Supply Unit when the output voltage is abnormal.

3.4.3 Troubleshooting I/F-related Problems

This section provides information for troubleshooting problems related to the USB interfaces and the Memory Card Slot.

□ USB Interface Error

Table 3-23. USB I/F Error

Problem	Check Point	Remedy
Incorrect printer driver installation	Click My Computer - Property - Device Manager on Windows computer. Is the printer driver is included in the Other Devices by mistake?	Uninstall the driver and reinstall it correctly referring to the Users Guide.
USB cable failure	Replace the cable with another one. Does the problem still occur?	Replace the USB cable.
Poor connection	Is the USB terminal free from foreign materials?	Remove the foreign material, and clean the contact points.
Main board failure	Check the Main Board for any damage.	Replace the Main Board.
Card board failure	Check the STG Board for any damage.	Replace the STG Board.

□ Troubleshooting Memory Card-related Problems

Table 3-24. Troubleshooting Memory Card-related problems

Problem	Check Point	Remedy
Memory Card data damage	Is the data on the memory card damaged by static electricity or the like?	Check if the card is readable with the computer. If not, format the card.
Use unsupported Memory Card	Check if the card is supported.	Use a supported memory card.
Memory card failure	Check if another Memory Card is recognized.	Replace the Memory Card with a new one.
Poor connection	Are the memory card or the slot free from foreign materials?	Remove the foreign material, and clean the contact points.
	Is the slot pin cracked or deformed?	Replace the Card Board.
Firmware error	---	Update the firmware.
Memory card can not be ejected	Is the memory card inserted without the memory card adapter?	Turn the power off and remove the memory card with the tweezers.
Electrical noise	Are the positions of the FFC and ferrite core appropriate?	Replace the Main Board with a new one if there is no problem with the routing.
Main board failure	Check the Main Board for any damage.	Replace the Main Board with a new one.
Card board failure	Check the STG Board for any damage.	Replace the STG Board.

3.5 Troubleshooting Duplex Unit Problems

This section provides troubleshooting information on the duplex unit. Find the problem you face in [Table 3-25](#), and troubleshoot the problem referring to the descriptions given in the “Possible Cause” and “Remedy”.

□ Problems and reference table

Table 3-25. Duplex Unit Problems & Reference Table

Error Message	Problem	Reference
Duplex unit open error	The duplex unit cannot be detected when it is working.	Table 3-26 (p.78)
Duplex unit paper jam error	A paper jam error occurred in the duplex unit.	Table 3-27 (p.78)

□ Duplex unit open error

Table 3-26. Duplex unit open error

Symptom	Possible Cause	Remedy
The duplex unit open error occurs when duplex printing is started.	1. The duplex unit is not installed correctly.	Install the duplex unit correctly.
	2. Duplex unit sensor failure/wrong connection	Check if the duplex unit sensor is correctly connected. If not, replace the printer mechanism with a new one. Check if the duplex unit sensor is damaged. If so, replace the printer mechanism with a new one.
The duplex unit open error occurs when duplex printing is started after recovering from a duplex unit paper jam error.	1. The duplex unit is not installed correctly.	Install the duplex unit correctly. (The duplex printing is resumed from the next page)
		Cancel the duplex print job.

□ Duplex unit paper jam error

Table 3-27. Duplex unit paper jam error

Symptom	Possible Cause	Remedy
The duplex unit paper jam error occurs when duplex printing is started.	1. A paper jam occurred in the duplex unit.	Remove the duplex unit (open the cover if necessary), and remove the paper. Leave the printer ON during the work. Then reinstall the unit. (The duplex printing is resumed from the next page)
	2. A paper jam occurred in the duplex unit or the printer failed to detect the duplex unit while reversing the paper for printing on its backside.	
	3. PE sensor failure/wrong connection	Check if the PE sensor is correctly connected. If not, connect it correctly. (See Table 3-2, 4.2.4.19 "Upper Paper Guide L/R / PE Sensor" (p.161)) Check if the PE sensor is damaged. If so, replace the Rear Paper Guide with a new one. (See Table 3-2, 4.2.4.19 "Upper Paper Guide L/R / PE Sensor" (p.161))

Note : If any of the above remedies cannot solve the problem, replace the duplex unit with a new one.

3.6 Network Troubleshooting

The following table describes the troubleshooting related to the Network function of the Epson Artisan 800/Epson Stylus Photo PX800FW/TX800FW/Epson Artisan 700/Epson Stylus Photo PX700W/TX700W.

□ Troubles in Network Settings

Table 3-28. Troubles in Network Settings

Symptom	Check Point	Remedy
Connection with Access Point/ Detection of Access Point can not be made (Wireless LAN)	1. Check if Access Point is ready for the connection.	Check if the connection can be made from the other devices.
	2. Check if Access Point is too far from the printer or blocked by obstruction.	Move Access Point closer to the printer or clear off the obstruction.
	3. Check if Access Point has any limitation for the access.	Check Access Point and change the setting for the access by setting the MAC Address or IP Address, etc. of the printer.
	4. Check if Access Point setting is made for non-display of the SSID (Network).	Input the SSID from the Control Panel.
	5. Check if WEP key or setting for the password is correct.	Check the WEP key and the password in a case-sensitive manner.
Communication with wired LAN can not be made	1. Check if the Wireless LAN Setting on the Control Panel is "Disable".	Change the Wireless LAN Setting into "Disable", because Wireless LAN and Wired LAN can not be used at the same time.
	2. Check if the combination for the HUB and router etc. and Link Speed of the Printer is proper.	Correct the Link Speed setting properly.
	3. Check if 10Base-T Repeater HUB is used.	Try other HUBs (Switching HUB etc.).

□ Troubles in installing a software

Table 3-29. Troubles in Installing a Software

Symptom	Check Point	Remedy
"Can not connect to internet thru LAN" is displayed.	1. In Wireless LAN's case, check if the network connection between the PC and Access Point is made.	Correctly connect the computer and the Access Point.
	2. In Wired LAN's case, check if the computer and the printer are properly connected to a LAN port such as a hub or router using a LAN cable.	Correctly connect the computer and the printer to a LAN port such as a hub or router using a LAN cable.
	3. Check the status of network settings/connection by printing the network status sheet.	Correctly set the network connection again if the network connection is not made.
	4. Check if the link lamp on the Access Point or hub connected to the printer is lighting or flashing.	<ul style="list-style-type: none"> • Try using another port. • Replace the LAN cable. • Configure Wireless LAN setting correctly.
	5. Check is IP address is correctly set.	Correctly set IP address.
	6. For the setting of the Windows Firewall or commercially available security software, check if the installed network access is set to "Shut down" or "Block" etc.	Set the Windows Firewall or commercially available security software as the exceptional application. *If the problem is not solved when using the commercially available security software, restart it once.

- Troubles during printing and scanning from PC

Table 3-30. Troubles during printing and scanning from PC

Symptom	Check Point	Remedy
Print cannot be made Scan cannot be made	1. In Wireless LAN's case, check if the network connection between the PC and Access Point is made.	Correctly connect the computer and the Access Point.
	2. In Wired LAN's case, check if the computer and the printer are properly connected to a LAN port such as a hub or router.	Correctly connect the computer and the printer to a LAN port such as a hub or router using a LAN cable.
	3. Check the status of network settings/connection by printing the network status sheet.	Correctly set the network connection again if the network connection is not made.
	4. Check if the link lamp on the Access Point or hub connected to the printer is lighting or flashing.	<ul style="list-style-type: none"> • Try using another port. • Replace the LAN cable. • Configure Wireless LAN setting correctly.
	5. Check if the network settings are correctly configured?	Correctly configure the network settings.
	6. Check if the network setting screen is displayed on the Control Panel.	Close the screen.
EPSON Scan cannot be started	1. For EPSON Scan settings, check if IP address is set directly.	If IP address is set using the DHCP function, specify IP address by searching address.

3.7 FAX Troubleshooting (Epson Artisan 800/ Epson Stylus Photo PX800FW/TX800FW only)

3.7.1 FAX Log

When an error related to fax occurs, it is not only indicated on the LCD but also saved as a log file. The error code is recorded in it, and according to this log the contents of the error can be confirmed

Table 3-31. FAX Log (1)

Log Name	Description	Save Destination														
Latest log (Last Transaction)	The latest communication log of sending / polling reception	Nonvolatile memory														
Communication log (Fax Log)	The following information is stored.	Nonvolatile memory														
	<table border="1"> <thead> <tr> <th>Item</th> <th>Information</th> </tr> </thead> <tbody> <tr> <td>Communication start date / time</td> <td>Year/month/day/hour/minute</td> </tr> <tr> <td>Communication type</td> <td>Sending/receiving/polling reception</td> </tr> <tr> <td>Communication ID</td> <td> Sending/polling reception: <ul style="list-style-type: none"> Destination name of speed dial (first 20 characters) Telephone number (last 20 characters) Destination fax ID (20 characters) Receiving: <ul style="list-style-type: none"> Destination fax ID (20 characters) </td> </tr> <tr> <td>Airtime</td> <td>Hour/minute/second</td> </tr> <tr> <td>Communication pages</td> <td>0 to 100</td> </tr> <tr> <td>Communication result</td> <td> Common: Normal/cancel/error code* Sending/polling reception: No dial tone detected/No fax signal detected/Busy tone detected </td> </tr> </tbody> </table>		Item	Information	Communication start date / time	Year/month/day/hour/minute	Communication type	Sending/receiving/polling reception	Communication ID	Sending/polling reception: <ul style="list-style-type: none"> Destination name of speed dial (first 20 characters) Telephone number (last 20 characters) Destination fax ID (20 characters) Receiving: <ul style="list-style-type: none"> Destination fax ID (20 characters) 	Airtime	Hour/minute/second	Communication pages	0 to 100	Communication result	Common: Normal/cancel/error code* Sending/polling reception: No dial tone detected/No fax signal detected/Busy tone detected
	Item		Information													
	Communication start date / time		Year/month/day/hour/minute													
	Communication type		Sending/receiving/polling reception													
	Communication ID		Sending/polling reception: <ul style="list-style-type: none"> Destination name of speed dial (first 20 characters) Telephone number (last 20 characters) Destination fax ID (20 characters) Receiving: <ul style="list-style-type: none"> Destination fax ID (20 characters) 													
	Airtime		Hour/minute/second													
Communication pages	0 to 100															
Communication result	Common: Normal/cancel/error code* Sending/polling reception: No dial tone detected/No fax signal detected/Busy tone detected															
Note * : For error codes, see Table 3-33. Error Code List (p.82) .																
Power failure log (Fax Log)	The information stored in this log is the same as the communication log. However, since the airtime is "Unknown" in this case, the result of it is recorded as "power failure".	Nonvolatile memory														



- The communication log is not stored under the following conditions:
- When the sending operation is canceled while storing B&W image or waiting for redialing.
 - In the case of a power failure during the operation of sending/polling reception including waiting status for redial, or during receive operation.
 - When the receiving operation is canceled before the fax signal is detected.
 - If the fax signal is not detected during receiving operation.

Table 3-32. FAX Log (2)

Log Name	Description	Save Destination																		
Protocol trace	The following information of the latest communication is stored.	Volatile memory																		
	<table border="1"> <thead> <tr> <th>Item</th> <th>Information</th> </tr> </thead> <tbody> <tr> <td>Communication start date / time</td> <td>Year/month/day/hour/minute</td> </tr> <tr> <td>Communication type</td> <td>Sending/receiving/polling reception</td> </tr> <tr> <td>Communication ID</td> <td> Sending/polling reception: <ul style="list-style-type: none"> Destination name of speed dial (first 20 characters) Telephone number (last 20 characters) Destination fax ID (20 characters) Receiving: <ul style="list-style-type: none"> Destination fax ID (20 characters) </td> </tr> <tr> <td>Airtime</td> <td>Hour/minute/second</td> </tr> <tr> <td>Communication pages</td> <td>0 to 100</td> </tr> <tr> <td>Communication result</td> <td> Common: Normal/cancel/error code Sending/polling reception: No dial tone detected/No fax signal detected/Busy tone detected </td> </tr> <tr> <td>Diagnosing code</td> <td>10 bytes</td> </tr> <tr> <td>Protocol data</td> <td> The latest 43 commands/responses* <ul style="list-style-type: none"> Time stamp Sending / receiving Command /response code (See Table 3-34. Command/Response Code (p.83)) FCF/FIF (first 33 octets). </td> </tr> </tbody> </table>		Item	Information	Communication start date / time	Year/month/day/hour/minute	Communication type	Sending/receiving/polling reception	Communication ID	Sending/polling reception: <ul style="list-style-type: none"> Destination name of speed dial (first 20 characters) Telephone number (last 20 characters) Destination fax ID (20 characters) Receiving: <ul style="list-style-type: none"> Destination fax ID (20 characters) 	Airtime	Hour/minute/second	Communication pages	0 to 100	Communication result	Common: Normal/cancel/error code Sending/polling reception: No dial tone detected/No fax signal detected/Busy tone detected	Diagnosing code	10 bytes	Protocol data	The latest 43 commands/responses* <ul style="list-style-type: none"> Time stamp Sending / receiving Command /response code (See Table 3-34. Command/Response Code (p.83)) FCF/FIF (first 33 octets).
	Item		Information																	
	Communication start date / time		Year/month/day/hour/minute																	
	Communication type		Sending/receiving/polling reception																	
	Communication ID		Sending/polling reception: <ul style="list-style-type: none"> Destination name of speed dial (first 20 characters) Telephone number (last 20 characters) Destination fax ID (20 characters) Receiving: <ul style="list-style-type: none"> Destination fax ID (20 characters) 																	
	Airtime		Hour/minute/second																	
	Communication pages		0 to 100																	
	Communication result		Common: Normal/cancel/error code Sending/polling reception: No dial tone detected/No fax signal detected/Busy tone detected																	
	Diagnosing code		10 bytes																	
Protocol data	The latest 43 commands/responses* <ul style="list-style-type: none"> Time stamp Sending / receiving Command /response code (See Table 3-34. Command/Response Code (p.83)) FCF/FIF (first 33 octets). 																			
Note * : If a large amount of FIF is received, the recorded command/response may be less than 43.																				

□ Error codes

Table 3-33. Error Code List

Error Code (HEX)	Phenomenon	LCD Display	Print Example
000	Successful completion (Monochrome)	Complete	OK
C000	Successful completion (Color)	Complete	OK Color
400	Communication error	Communication error	Error code
401	Communication error	Communication error	Error code
402	Communication error	Communication error	Error code
403	Communication error	Communication error	Error code
404	Communication error	Communication error	Error code
405	Communication error	Communication error	Error code
407	Communication error	Communication error	Error code
408	Communication error	Communication error	Error code
409	Communication error	Communication error	Error code
410	Communication error	Communication error	Error code
412	Communication error	Communication error	Error code
416	Communication error	Communication error	Error code
417	Communication error	Communication error	Error code
418	Communication error	Communication error	Error code
420	Fax signal was not detected during receive operation. (The call was a telephone call)	Not displayed	---
421	Communication error	Communication error	Error code
422	Communication error	Communication error	Error code
427	Communication error	Communication error	Error code
433	Communication error	Communication error	Error code
434	Communication error	Communication error	Error code
436	Communication error	Communication error	Error code
459	Communication error	Communication error	Error code
490	Communication error	Communication error	Error code
494	Communication error	Communication error	Error code
495	Communication error	Communication error	Error code
496	Communication error	Communication error	Error code
501	Communication error	Communication error	Error code
502	Communication error	Communication error	Error code
503	Communication error	Communication error	Error code
504	Communication error	Communication error	Error code

Table 3-33. Error Code List

Error Code (HEX)	Phenomenon	LCD Display	Print Example
505	Communication error	Communication error	Error code
540	Communication error	Communication error	Error code
541	Communication error	Communication error	Error code
542	Communication error	Communication error	Error code
543	Communication error	Communication error	Error code
544	Communication error	Communication error	Error code
550	Communication error	Communication error	Error code
554	Communication error	Communication error	Error code
620	Communication error	Communication error	Error code
621	Communication error	Communication error	Error code
623	Communication error	Communication error	Error code
624	Communication error	Communication error	Error code
630	A busy tone was detected after dialing	Talking (Line Busy)	Talking (Line Busy)
631	Communication error	Communication error	Error code
632	Communication error	Communication error	Error code
633	Communication error	Communication error	Error code
634	A fax signal was not detected for a given length of time after dialing	No Answer	No Answer
637	A dial tone was not detected before dialing	No Dial Tone	No Dial Tone
638	A power failure occurred during communication	Not displayed	Power Fail
700	The communication was canceled by an operation	Canceled	Canceled
706	System error	System Error	Error code
709	Communication error	Communication error	Error code
815	Communication error	Communication error	Error code
870	The image memory is full	Memory Full	Memory Full
871	The maximum number of files was exceeded	Error code	Error code
873	Communication error	Communication error	Error code
874	Communication error	Communication error	Error code
875	Communication error	Communication error	Error code
880	System error	System Error	Error code
881	System error	System Error	Error code

Table 3-33. Error Code List

Error Code (HEX)	Phenomenon	LCD Display	Print Example
882	System error	System Error	Error code
883	System error	System Error	Error code
884	System error	System Error	Error code
928	Collision (A call signal was detected when shifting to dial operation)	Not displayed	---
F0B	Communication error	Communication error	Error code
F1E	Communication error	Communication error	Error code
F20	Communication error	Communication error	Error code
F21	System error	System Error	Error code
F23	Communication error	Communication error	Error code
F24	Communication error	Communication error	Error code
F25	Communication error	Communication error	Error code
F27	System error	System Error	Error code
F28	System error	System Error	Error code
F29	Communication error	Communication error	Error code
F2A	Communication error	Communication error	Error code
F2B	No image data for reprint exists	No Image	---
F2F	System error	System Error	Error code
F3A	Communication error	Communication error	Error code
F51	System error	System Error	Error code
F57	Communication error	Communication error	Error code
F58	Communication error	Communication error	Error code
F59	System error	System Error	Error code
F60	A scanner fatal error occurs	See Table 3-3. Error Indications and Fault Occurrence Causes (p.56)	Error code
F61	A printer fatal error occurs	See Table 3-3. Error Indications and Fault Occurrence Causes (p.56)	Error code
F62	Reserved	---	Error code
F63	ADF misfeed or paper jam occurred	---	Error code
F64	The memory for printing received image is full	Error code	Error code

□ Command/response code

Table 3-34. Command/Response Code

Command/ response code	FCF value (HEX) (LSB first: X=0)		Content
	First	Second	
DIS	80	-	Digital Identification Signal
CSI	40	-	Called Subscriber Identification
NSF	20	-	Non-Standard Facilities
DTC	81	-	Digital Transmit Command
CIG	41	-	CallInG subscriber identification
NSC	21	-	Non-Standard facilities Command
PWD	C1	-	PassWoRD
SEP	A1	-	Selective Polling
Reserved (PSA)	61	-	Polled SubAddress
Reserved (CIA)	E1	-	Calling subscriber Internet Address
Reserved (ISP)	11	-	Internet Selective Polling address
DCS	82	-	Digital Command Signal
TSI	42	-	Transmitting Subscriber Identification
NSS	22	-	Non-Standard facilities Set-up
SUB	C2	-	SUBaddress
SID	A2	-	Sender IDentification
TRN	E6	-	Training
TCF	F0	-	Training Check
CTC	12	-	Continue To Correct
Reserved (TSA)	62	-	Transmitting Subscriber internet Address
Reserved (IRA)	E2	-	Internet Routing Address
CFR	84	-	ConFirmation to Receive
FTT	44	-	Failure To Train
CTR	C4	-	Response for Continue To correct
Reserved (CSA)	24	-	Called Subscriber internet Address
EOM	8E	-	End Of Message
MPS	4E	-	MultiPage Signal
EOP	2E	-	End Of Procedure
PRI-EOM	9E	-	Procedure Interrupt-End Of Message
PRI-MPS	5E	-	Procedure Interrupt-MultiPage Signal
PRI-EOP	3E	-	Procedure Interrupt-End Of Procedure
Reserved (EOS)	1E	-	End Of Selection
PPS-EOM	BE	8E	Partial Page Signal-End Of Message

Table 3-34. Command/Response Code

Command/ response code	FCF value (HEX) (LSB first: X=0)		Content
	First	Second	
PPS-MPS	BE	4E	Partial Page Signal-MultiPage Signal
PPS-EOP	BE	2E	Partial Page Signal-End Of Procedure
PPS-PRI-EOM	BE	9E	Partial Page Signal-Procedure Interrupt- End Of Message
PPS-PRI-MPS	BE	5E	Partial Page Signal-Procedure Interrupt- MultiPage Signal
PPS-PRI-EOP	BE	3E	Partial Page Signal-Procedure Interrupt- End Of Procedure
PPS-EOS	BE	1E	Partial Page Signal-End Of Selection
PPS-NULL	BE	00	Partial Page Signal-partial page boundary
EOR-EOM	CE	8E	End Of Retransmission-End Of Message
EOR-MPS	CE	4E	End Of Retransmission-MultiPage Signal
EOR-EOP	CE	2E	End Of Retransmission-End Of Procedure
EOR-PRI-EOM	CE	9E	End Of Retransmission-Procedure Interrupt-End Of Message
EOR-PRI-MPS	CE	5E	End Of Retransmission-Procedure Interrupt-MultiPage Signal
EOR-PRI-EOP	CE	3E	End Of Retransmission-Procedure Interrupt-End Of Procedure
EOR-EOS	CE	1E	End Of Retransmission-End Of Selection
EOR-NULL	CE	00	End Of Retransmission- partial page boundary
RR	6E	-	Receive Ready
MCF	8C	-	Message ConFirmation
RTP	CC	-	ReTrain Positive
RTN	4C	-	ReTrain Negative
PIP	AC	-	Procedure Interrupt Positive
PIN	2C	-	Procedure Interrupt Negative
PPR	BC	-	Partial Page Request
RNR	EC	-	Receive Not Ready
ERR	1C	-	Response for End of Retransmission
Reserved (FDM)	FC	-	File Diagnostic Message
DCN	FA	-	DisCoNnect
CRP	1A	-	Command RePeat
Reserved (FNV)	CA	-	Field Not Valid

Table 3-34. Command/Response Code

Command/ response code	FCF value (HEX) (LSB first: X=0)		Content
	First	Second	
PIX	FF	-	PIXel image
Space	Other combinations		Unknown command/response

3.7.2 Error Code/Superficial Phenomenon-Based Troubleshooting

This section explains the troubleshooting procedures based on the error codes and superficial phenomenon.



- When an error occurs, it may be displayed on the LCD panel with a message instead of an error code. To check the error code, print out a fax log.
- If the problem is not solved even after carrying out the remedy shown in the [Table 3-35](#), print out a protocol trace to analyze the cause of the error.

Table 3-35. Troubleshooting based on the error code/superficial phenomenon

Error code (LCD Message)/Phenomenon	Description	Remedy
Communication Error (The error is indicated with error code on the fax log.)	Communication error	Turn off v.34 and try again. Turn off ECM and try again. When using xDSL, check the connection from “Line” jack to the fax via the xDSL splitter. When using TAM, check the connection from “Line” jack to the TAM via the fax. Check if the telephone line makes any sounds.
Line Busy	The line is busy.	Try again later.
No answer	The other end of the line does not answer.	Check the number and dial again.
	The other end of the line answered but no answer tone is detected.	
Power fail	Power failure occurred during sending/receiving/printing/redialing.	Confirm the PS Board Connector Cable/PS Board is not damaged, and retry.
706,880-884,F21,F27-F28,F2F,F51,F59	A system error (fax circuit failure) occurs	Replace the Main board with a new one.
Memory full	Out of Memory	Ask the sender to resend the fax in several batches.
871	Maximum number of files is exceeded	
F60	A scanner fatal error occurred	<ul style="list-style-type: none"> • See Table 3-4 "Check point for Fatal error according to each phenomenon (Printer Mechanism)" (p.58). • See Table 3-5 "Check point for Fatal error according to each phenomenon (Scanner)" (p.64).
F61	A printer fatal error occurred	
F62-F63	Reserved	---
F64	The memory for printing received image is full	Ask the sender to resend the fax in several batches.
	The telephone cable is not connected properly.	Connect the telephone cable properly.
	The telephone line is not working.	Verify if the phone line works by connecting to a phone to it.
	Auto answer is set to “N”.	Set to “Y”.
	DRD setting is incorrect.	Set the setting to “ALL” and try again. Should other ring patterns be selected, contact the telephone company.
Cannot receive faxes	Calling signal cannot be detected.	Contact the telephone company or obtain the fax log for more analysis.

Table 3-35. Troubleshooting based on the error code/superficial phenomenon

Error code (LCD Message)/Phenomenon	Description	Remedy
Cannot dial	The telephone cable is not connected properly.	Connect the telephone cable properly.
	The telephone line is not working.	Verify if the phone line works by connecting to a phone to it.
	Pulse/Tone dial setting error	Turn the setting to the other one and try again.
Cannot receive/send faxes in color	ECM is set to off.	Set to on and try again.
	Fax mode is set to "B&W only".	Set to "B&W/Color".
Cannot print all the received data when printing data stored in memory	The size of the memory is 2.0 Mbyte. If the data becomes over the set threshold, oldest data are deleted to make room for new ones.	Ask the sender to resend the data if necessary because the data deleted from the memory can not be restored.
Images run off the paper	Auto reduction is set to off.	Set auto reduction to on and reprint the data.
	Paper size setting does not match the size of the received data.	Choose the correct setting and reprint the data.
	Paper size setting does not match the size of papers in the tray.	Choose the correct setting or load correct sized papers in the tray and reprint the data.

3.8 Fax Function/External Connection Function Check (Epson Artisan 800/Epson Stylus Photo PX800FW/TX800FW only)

3.8.1 Outline

Fax function/External connection (EXT port) function must be checked in addition to usual printing/scanning function after repairing/refurbishing the defective units. The following table describes each check method. Select an applicable Fax Function check method in your repair center and implement this operation.

Table 3-36. Fax Function/EXT port Function check

Checked Function	Check Method	Necessary Tools	Check Point
Fax Function	Method A*1 (PC FAX) (p.87)	<ul style="list-style-type: none"> • PC (OS: Win XP) • Repaired/Refurbished unit (1unit) • Telephone line simulator*1 (1pcs.) • Fax cable (2pcs.) 	<p>[Sender's check point] Make sure that printer send fax data correctly.</p> <p>[Receiver's check point] Make sure that printer receive fax data correctly.</p>
	Method B*1 (Only simulator) (p.91)	<ul style="list-style-type: none"> • Guaranteed unit (e.g. one of these models) • Repaired/Refurbished unit (1unit) • Telephone line simulator*1 (1pcs.) • Fax cable (2pcs.) 	
	Method C (PBX FAX) (p.92)	<ul style="list-style-type: none"> • Guaranteed unit (e.g. one of these models) • Repaired/Refurbished unit (1unit) • PBX in your office (internal phone) • Fax cable (2pcs.) 	
External Connection (EXT port) Function	--- *2	<ul style="list-style-type: none"> • Telephone (1pcs.) • Fax cable (1pcs.) 	<ol style="list-style-type: none"> 1. Check if you can hear ringing tone from telephone before receiving fax. In this case, the telephone sounds ringing. 2. Check if you can't hear dial tone from the telephone during receiving fax data. In this case, the telephone doesn't sound dial tone.

Note *1: In case of these methods, you have to use telephone line simulator for checking fax function. For your reference, web site address of the simulator is outlined below. (as of August 2007)

http://www.telephonetribute.com/telco_line_simulators.html

<http://www.skutchelectronics.com/sims.htm>

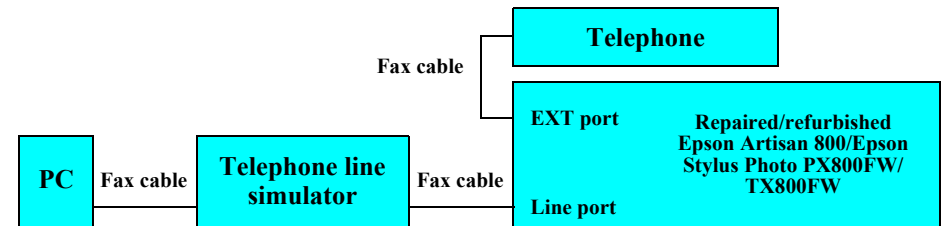
*2: You have to check this test whether you select any check method above.

3.8.2 Fax Function and External Connection Function Check

The following shows the detailed check condition/procedure of each method.

3.8.2.1 Fax Function Check by [Method A] and External Connection Function Check

SETTING METHOD



*Regarding FAX number, refer to the telephone line simulator's manual.

*Repaired/refurbished Epson Artisan 800/Epson Stylus Photo PX800FW/TX800FW is represented by "R" unit from this.
*Select default setting to "R" unit before this check referring to the following table.

Table 3-37. Default Settings of Repaired Epson Artisan 800/Epson Stylus Photo PX800FW/TX800FW ("R")

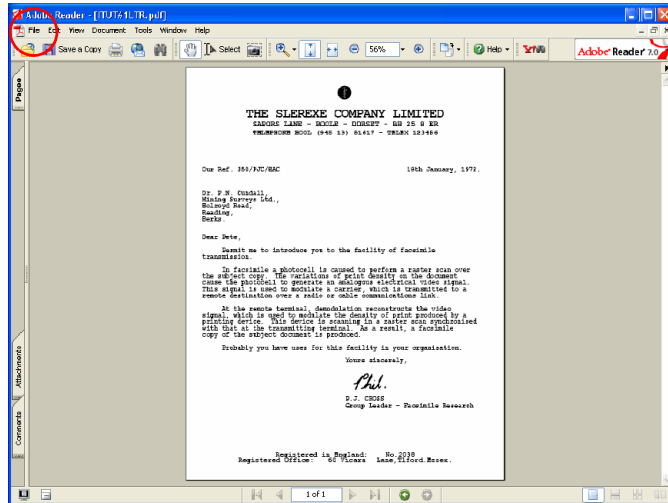
No	Function	Default Setting
1	Resolution	Standard
2	Contrast	Normal
3	Paper size	For US, Canada, Latin: "Letter" For other destinations: "A4"
4	Automatic reduction	On
5	Last transmission report	Off
6	Dial mode	Tone
7	DRD	All
8	ECM	On
9	V.34	On
10	Rings to answer	"5" *For Taiwan, Singapore: "2"

Note *: This default setting is applied for [Condition B] and [Condition C].

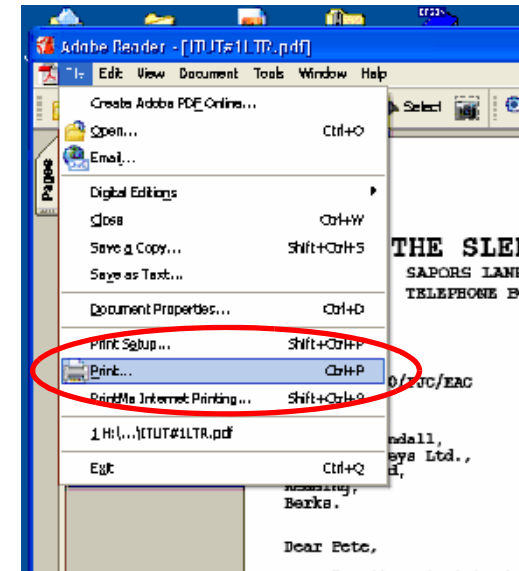
CHECK PROCEDURE

[Sender: PC =>Receiver: "R" unit]

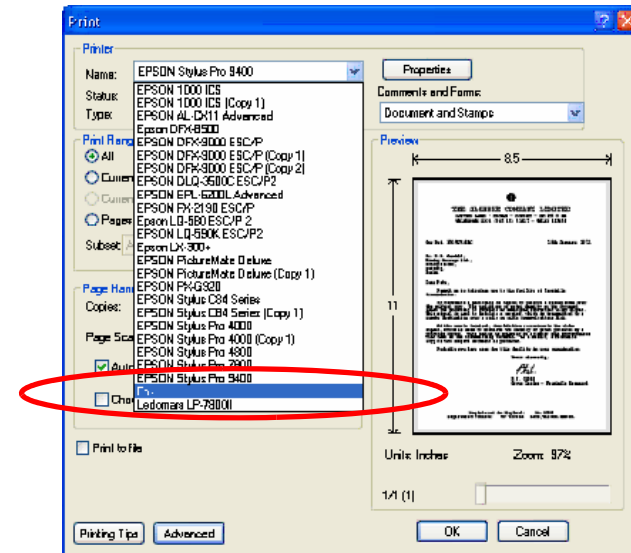
1. Install test chart (test chart name: "ITUT#1LTR.pdf") to PC.
2. Open test chart and select "File" menu.



3. Select "Print.....".



4. Select "Fax" from "Printer Name".



5. Input "Receiver Name" and "Fax Number", and click "Next" button.

Send Fax Wizard

Recipient Information
Enter the name and number of the person you want to send the fax to, or click Address Book to select a fax recipient.

To: SEC Address Book...

Location: Japan (81)

Fax number: 0123456789

Use dialing rules My Location Dialing rules...

To send to multiple recipients, type each recipient's information above, and then click Add to add the recipient to the list below.

Recipient name	Fax number
SEC	0123456789

Add Remove Edit

< Back Next > Cancel

6. Click "Next" button.

Send Fax Wizard

Preparing the Cover Page
Select a cover page template, and type a subject line and note if required by the template. The information is automatically added to the cover page.

Select a cover page template with the following information

Cover page template: confident Sender Information...

Subject line:

Note:

< Back Next > Cancel

7. Check as below screen, and click "Next" button.

Send Fax Wizard

Schedule
Specify when you want your fax to be sent, and set priority. Higher priority faxes will be sent first.

When do you want to send this fax?

Now

When discount rates apply

Specific time in the next 24 hours: 7:38:28 PM

What is the fax priority?

High

Normal

Low

< Back Next > Cancel

8. Click "Finish" button to send fax data from PC to "R" unit.

Send Fax Wizard

Completing the Send Fax Wizard
You have successfully created a fax as follows:

From:

Recipient name	Fax number
SEC	0123456789

Cover page template: <None Specified>

Subject: <None Specified>

Time to send: Now

Preview Fax...

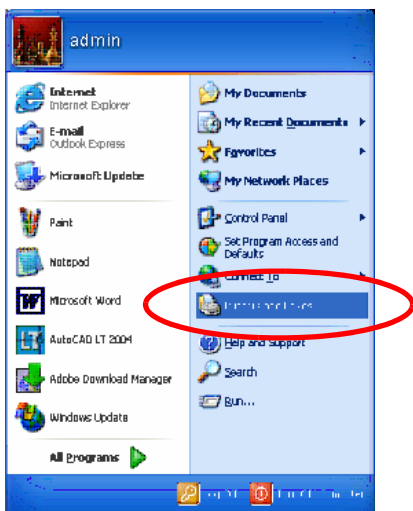
To send your fax, click Finish.

< Back Finish Cancel

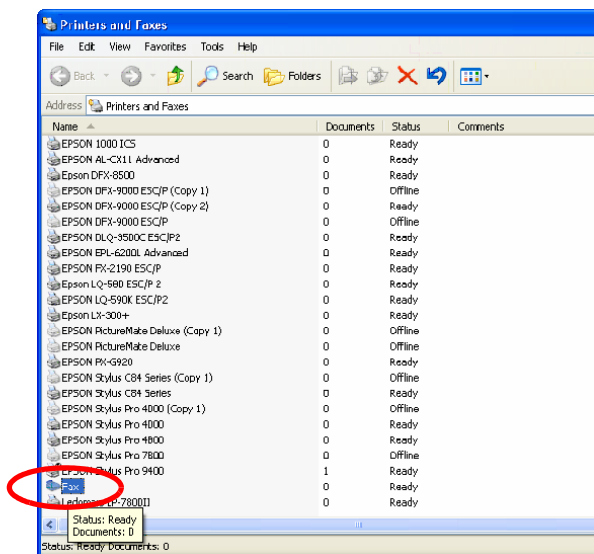
9. Confirm if telephone rings correctly during calling tone of "R" unit rings.
10. Confirm if dial tone of telephone is lost during "R" unit receives fax data without calling tone.

[Sender: "R" unit => Receiver: PC]

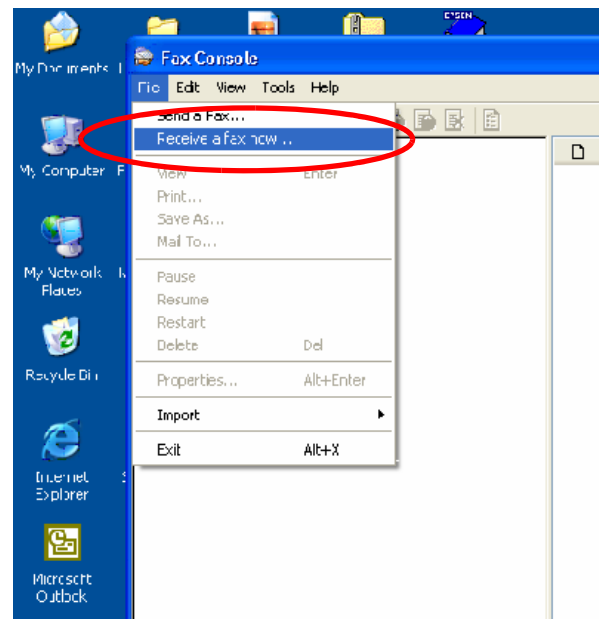
1. Select "Printer and Faxes" from Windows start menu.



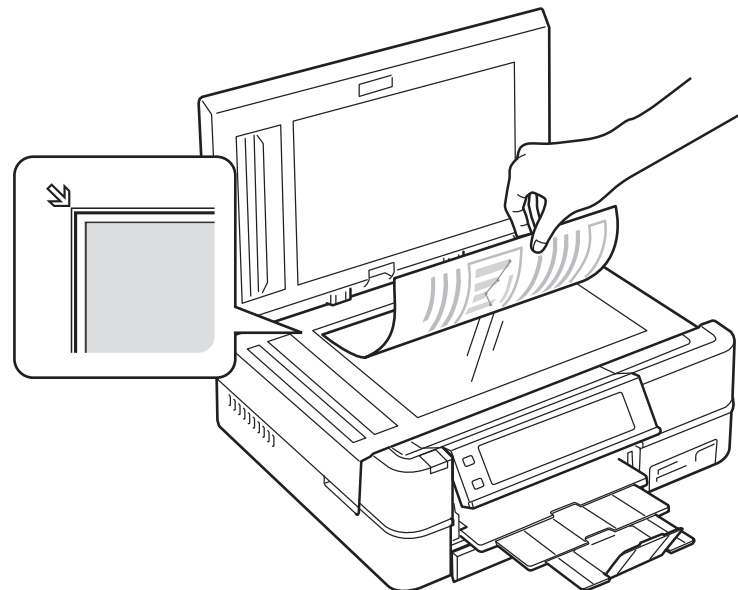
2. Select "Fax console" window.



3. Select "Receiver a fax now...." from file menu.



4. Set test chart on the document glass of "R" unit.



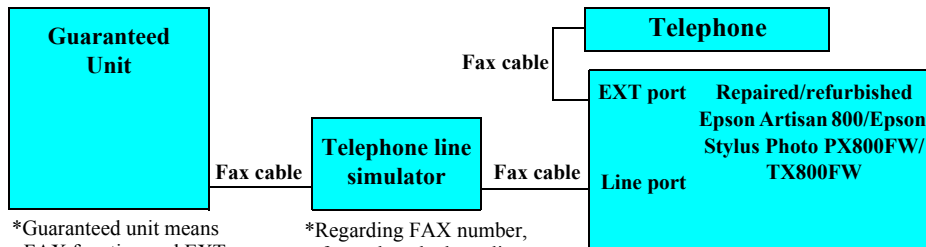
5. Enter fax mode by pushing fax button.
6. Input fax number of PC on “R” unit. (Regarding FAX number, refer to the telephone line simulator’s manual.)
7. Push “Start” button in “B&W” mode.
8. Push “Back” button after being displayed as “Send another page?” on LCD panel to send fax data from “R” unit to PC.

CHECK POINT OF “R” UNIT

Checked Function	Check Timing	Check Point
Fax Function	After sending of fax data	Make sure that “R” unit sends fax data correctly.
	After receiving of fax data	Make sure that “R” unit receives fax data correctly.
External Connection (EXT port) Function	During calling of fax (Step 9)	Check if you can hear ringing tone from telephone before receiving fax. In this case, the telephone sounds ringing.
	During receiving fax data (Step 10)	Check if you can’t hear dial tone from the telephone during receiving fax data. In this case, the telephone doesn’t sound dial tone.

3.8.2.2 Fax Function Check by [Method B] and External Connection Function Check

SETTING METHOD



*Guaranteed unit means FAX function and EXT port perform correctly. Guaranteed Epson Artisan 800/Epson Stylus Photo PX800FW/TX800FW is represented by “G” unit from this.

*Regarding FAX number, refer to the telephone line simulator’s manual.

*Repaired/refurbished Epson Artisan 800/Epson Stylus Photo PX800FW/TX800FW is represented by “R” unit from this.
*Refer to Table 3-37 on page 87 for default setting.

CHECK PROCEDURE

[Sender: “R” unit => Receiver: “G” unit]

1. Set test chart on the document glass of “R” unit.
2. Enter fax mode by pushing fax button.
3. Input fax number of “G” unit on “R” unit. (Regarding FAX number, refer to the telephone line simulator’s manual.)
4. Push “Start” button in “B&W” mode.
5. Push “Back” button after being displayed as “Send another page?” on LCD panel to send fax data from “R” unit to “G” unit.

[Sender: “G” unit => Receiver: “R” unit]

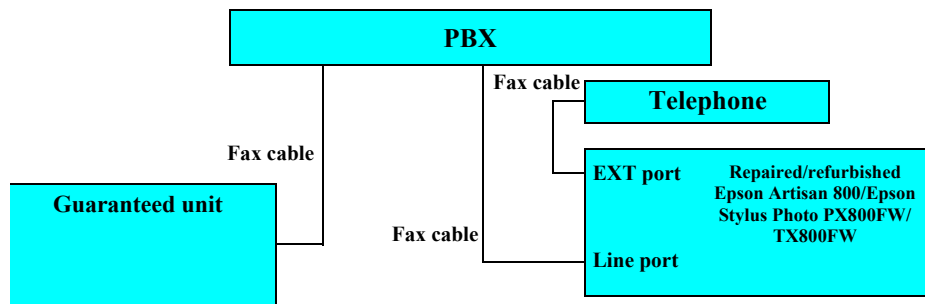
1. Set test chart on the document glass of “G” unit.
2. Enter fax mode by pushing fax button.
3. Input fax number of “R” unit on “G” unit. (Regarding FAX number, refer to the telephone line simulator’s manual.)
4. Push “Start” button in “B&W” mode.
5. Push “Back” button after being displayed as “Send another page?” on LCD panel to send fax data from “G” unit to “R” unit.
6. Confirm if telephone rings correctly during calling tone of “R” unit rings.
7. Confirm if dial tone of telephone is lost during “R” unit receives fax data without calling tone.

CHECK POINT OF “R” UNIT

Checked Function	Check Timing	Check Point
Fax Function	After sending of fax data	Make sure that “R” unit sends fax data correctly.
	After receiving of fax data	Make sure that “R” unit receives fax data correctly.
External Connection (EXT port) Function	During calling of fax (Step 6)	Check if you can hear ringing tone from telephone before receiving fax. In this case, the telephone sounds ringing.
	During receiving fax data (Step 7)	Check if you can’t hear dial tone from the telephone during receiving fax data. In this case, the telephone doesn’t sound dial tone.

3.8.2.3 Fax Function Check by [Method C] and External Connection Function Check

SETTING METHOD



*Guaranteed unit means FAX function and EXT port perform correctly. Guaranteed Epson Artisan 800/Epson Stylus Photo PX800FW/TX800FW is represented by "G" unit from this.

*Repaired/refurbished Epson Artisan 800/Epson Stylus Photo PX800FW/TX800FW is represented by "R" unit from this.
*Refer to [Table 3-37 on page 87](#) for default setting.

CHECK PROCEDURE

[Sender: "R" unit => Receiver: "G" unit]

1. Set test chart on the document glass of "R" unit.
2. Enter fax mode by pushing fax button.
3. Input fax number of "G" unit on "R" unit. (Regarding FAX number, refer to the telephone line simulator's manual.)
4. Push "Start" button in "B&W" mode.
5. Push "Back" button after being displayed as "Send another page?" on LCD panel to send fax data from "R" unit to "G" unit.

[Sender: "G" unit => Receiver: "R" unit]

1. Set test chart on the document glass of "G" unit.
2. Enter fax mode by pushing fax button.
3. Input fax number of "R" unit on "G" unit. (Regarding FAX number, refer to the telephone line simulator's manual.)
4. Push "Start" button in "B&W" mode.
5. Push "Back" button after being displayed as "Send another page?" on LCD panel to send fax data from "G" unit to "R" unit.
6. Confirm if telephone rings correctly during calling tone of "R" unit rings.
7. Confirm if dial tone of telephone is lost during "R" unit receives fax data without calling tone.

CHECK POINT OF "R" UNIT

Checked Function	Check Timing	Check Point
Fax Function	After sending of fax data	Make sure that "R" unit sends fax data correctly.
	After receiving of fax data	Make sure that "R" unit receives fax data correctly.
External Connection (EXT port) Function	During calling of fax (Step 6)	Check if you can hear ringing tone from telephone before receiving fax. In this case, the telephone sounds ringing.
	During receiving fax data (Step 7)	Check if you can't hear dial tone from the telephone during receiving fax data. In this case, the telephone doesn't sound dial tone.

CHAPTER

4

DISASSEMBLY/ASSEMBLY

4.1 Overview

This section describes procedures for disassembling the main components of Epson Artisan 800/Epson Stylus Photo PX800FW/TX800FW/Epson Artisan 700/Epson Stylus Photo PX700W/TX700W. Unless otherwise specified, disassembled units or components can be reassembled by reversing the disassembly procedure. Procedures which, if not strictly observed, could result in personal injury are described under the heading “WARNING”. “CAUTION” signals a precaution which, if ignored, could result in damage to equipment. Important tips for procedures are described under the heading “CHECK POINT”. If the assembly procedure is different from the reversed disassembly procedure, the correct procedure is described under the heading “REASSEMBLY”. Any adjustments required after reassembly of components or parts are described under the heading “ADJUSTMENT REQUIRED”. When you have to remove any components or parts that are not described in this chapter, refer to the exploded diagrams in the appendix.

Read the following precautions before disassembling and assembling.

4.1.1 Precautions

See the precautions given under the heading “WARNING” and “CAUTION” in the following columns when disassembling or assembling Epson Artisan 800/Epson Stylus Photo PX800FW/TX800FW/Epson Artisan 700/Epson Stylus Photo PX700W/TX700W.



- **Disconnect the power cable before disassembling or assembling the printer.**
- **If you need to work on the printer with power applied, strictly follow the instructions in this manual.**
- **Always wear gloves for disassembly and reassembly to protect your eyes from ink. If any ink gets in your eyes, wash your eyes with clean water and consult a doctor immediately.**
- **Always wear gloves for disassembly and reassembly to avoid injury from sharp metal edges.**
- **To protect sensitive microprocessors and circuitry, use static discharge equipment, such as anti-static wrist straps, when accessing internal components.**
- **Never touch the ink or wasted ink with bare hands. If ink comes into contact with your skin, wash it off with soap and water immediately. If you have a skin irritation, consult a doctor immediately.**



- **When powering this product, high-voltage current may be applied on some parts. To prevent ELECTRIC SHOCK, do not touch the following parts when the power is ON. If the shock should happen, the flowing current is very tiny, about a few hundreds μ A, therefore it will not do any harm on the human body.**
 - SUB Board
 - Cap section of the Ink System
 - The cables and terminals that connect above mentioned parts



- **When transporting the printer after installing the ink cartridge, pack the printer for transportation without removing the ink cartridge and be sure to secure the Ink Cartridge to the printer cover with tape tightly to keep it from moving.**
- **Use only recommended tools for disassembling, assembling or adjusting the printer.**
- **Observe the specified torque when tightening screws.**
- **Apply lubricants as specified. (See Chapter 6 “MAINTENANCE” (p247) for details.)**
- **Make the specified adjustments when you disassemble the printer. (See Chapter 5 “ADJUSTMENT” (p209) for details.)**
- **When reassembling the Waste Ink Tube, make sure that the tip of waste ink tube is placed in the correct position, otherwise ink may leak.**
- **When using compressed air products; such as air duster, for cleaning during repair and maintenance, the use of such products containing flammable gas is prohibited.**
- **Improper usage of the tool may adversely affect the quality seriously. Make sure to strictly observe the procedures in this manual to disassemble and assemble this product using proper tools.**
- **After disassembling/assembling, set the Transmission Arm to the Ink System position to avoid a fatal error caused by the locked Carriage. (See “4.2.4.6 Ink System (p135)”.)**

4.1.2 Tools

Use only specified tools to avoid damaging the printer.

Table 4-1. Tools

Name	Availability	EPSON Tool Code*
(+) Phillips screwdriver #1	O	1080530
(+) Phillips screwdriver #2	O	---
Flathead screwdriver	O	---
Flathead Precision screwdriver #1	O	---
Tweezers	O	---
Longnose pliers	O	---
Acetate tape	---	1003963
Nippers	O	---
Ink Supply Tube screwing tool	---	1508164
PG adjustment tool	---	1508165
Leak Check jig	---	---
Air Release jig	---	---
Carriage Stopper jig	---	---

Note *1: Some of the tools listed above are commercially available.

*2: EPSON provides the tools listed with EPSON tool code.

*3: Consult IJP CS Quality Assurance Department for how to get the Leak Check jig, the Air release jig and the Carriage stopper jig.

4.1.3 Work Completion Check

If any service is made to the printer, use the checklist shown below to confirm all works are completed properly and the printer is ready to be returned to the user.

Table 4-2. Work Completion Check

Classification	Item	Check Point	Status
Printer Unit	Self-test	Is the operation normal?	<input type="checkbox"/> OK / <input type="checkbox"/> NG
	ON-line Test	Is the printing successful?	<input type="checkbox"/> OK / <input type="checkbox"/> NG
	Printhead (Nozzle check pattern print)	Is ink discharged normally from all the nozzles?	<input type="checkbox"/> OK / <input type="checkbox"/> NG
	Carriage Mechanism	Does it move smoothly?	<input type="checkbox"/> OK / <input type="checkbox"/> NG
		Is there any abnormal noise during its operation?	<input type="checkbox"/> OK / <input type="checkbox"/> NG
		Is the CR Motor at the correct temperature? (Not too hot to touch?)	<input type="checkbox"/> OK / <input type="checkbox"/> NG
	Paper Feeding Mechanism	Is paper advanced smoothly?	<input type="checkbox"/> OK / <input type="checkbox"/> NG
		No paper jamming?	<input type="checkbox"/> OK / <input type="checkbox"/> NG
		No paper skew?	<input type="checkbox"/> OK / <input type="checkbox"/> NG
		No multiple feeding?	<input type="checkbox"/> OK / <input type="checkbox"/> NG
		No abnormal noise?	<input type="checkbox"/> OK / <input type="checkbox"/> NG
		Is the paper path free of any obstructions?	<input type="checkbox"/> OK / <input type="checkbox"/> NG
	Case open sensor check	Is the PF Motor at correct temperature?	<input type="checkbox"/> OK / <input type="checkbox"/> NG
		Does case open sensor operate normally? (See Chapter 5 "ADJUSTMENT" .)	<input type="checkbox"/> OK / <input type="checkbox"/> NG
	Transmission Arm position	Is the Transmission Arm set at the Ink System position? (See 4.2.4.6 "Ink System" (p.135) .)	<input type="checkbox"/> OK / <input type="checkbox"/> NG

Table 4-2. Work Completion Check

Classification	Item	Check Point	Status
Scanner unit	Mechanism	Is glass surface dirty?	<input type="checkbox"/> OK / <input type="checkbox"/> NG
		Is any foreign substance mixed in the CR movement area?	<input type="checkbox"/> OK / <input type="checkbox"/> NG
	CR mechanism	Does CR operate smoothly?	<input type="checkbox"/> OK / <input type="checkbox"/> NG
		Does CR operate together with scanner unit?	<input type="checkbox"/> OK / <input type="checkbox"/> NG
		Does CR make abnormal noise during its operation?	<input type="checkbox"/> OK / <input type="checkbox"/> NG
LED	Does LED turn on normally? And is white reflection test done near home position?	<input type="checkbox"/> OK / <input type="checkbox"/> NG	
ON-line Test	ON-line Test	Is the operation normal?	<input type="checkbox"/> OK / <input type="checkbox"/> NG
Copy	Copy	Is the local copy action normal?	<input type="checkbox"/> OK / <input type="checkbox"/> NG
Adjustment	Specified Adjustment	Are all the adjustment done correctly	<input type="checkbox"/> OK / <input type="checkbox"/> NG
Lubrication	Specified Lubrication	Are all the lubrication made at the specified points?	<input type="checkbox"/> OK / <input type="checkbox"/> NG
		Is the amount of lubrication correct?	<input type="checkbox"/> OK / <input type="checkbox"/> NG
Function	ROM Version	Version:	<input type="checkbox"/> OK / <input type="checkbox"/> NG
Packing	Ink Cartridge	Are the ink cartridges installed correctly?	<input type="checkbox"/> OK / <input type="checkbox"/> NG
	Waste Ink pad	Are the waste ink pads adequate to absorb?	<input type="checkbox"/> OK / <input type="checkbox"/> NG
	Protective materials	Is the printer carriage placed at the capping position?	<input type="checkbox"/> OK / <input type="checkbox"/> NG
	Securing Printer's Carriage	Is the CR stopper placed at the carriage securing position?	<input type="checkbox"/> OK / <input type="checkbox"/> NG
Others	Attachments, Accessories	Have all the relevant items been included in the package?	<input type="checkbox"/> OK / <input type="checkbox"/> NG

4.1.4 Additional Procedure/Procedural Differences

The disassembly/reassembly procedures of Epson Artisan800/Epson Stylus Photo PX800FW/Epson Stylus Photo TX800FW and Epson Artisan700/Epson Stylus Photo PX700W/Epson Stylus Photo TX700W are different. Unless otherwise specified, this chapter describes Epson Artisan800/Epson Stylus Photo PX800FW/Epson Stylus Photo TX800FW. Refer to the pages mentioned below for the disassembly/reassembly procedures of Epson Artisan700/Epson Stylus Photo PX700W/Epson Stylus Photo TX700W.

Each model is hereinafter called as follows.

Epson Artisan800/Epson Stylus Photo PX800FW/Epson Stylus Photo TX800FW: Artisan 800/PX800FW/TX800FW

Epson Artisan700/Epson Stylus Photo PX700W/Epson Stylus Photo TX700W: Artisan 700/PX700W/TX700W

Table 4-3. Procedure Differences

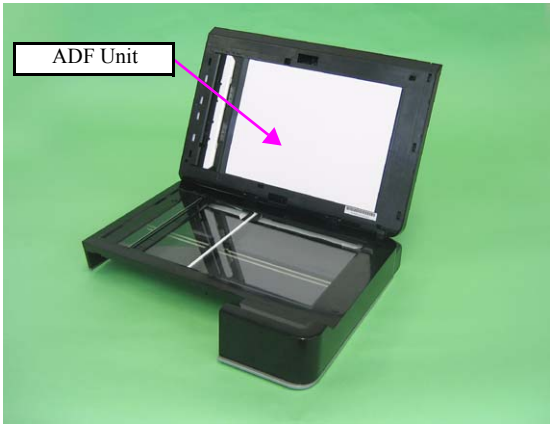
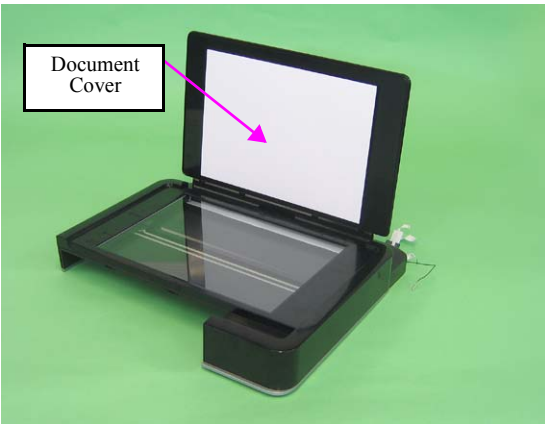
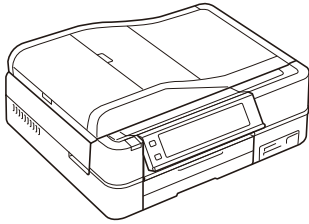
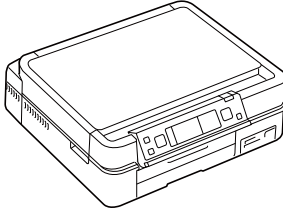
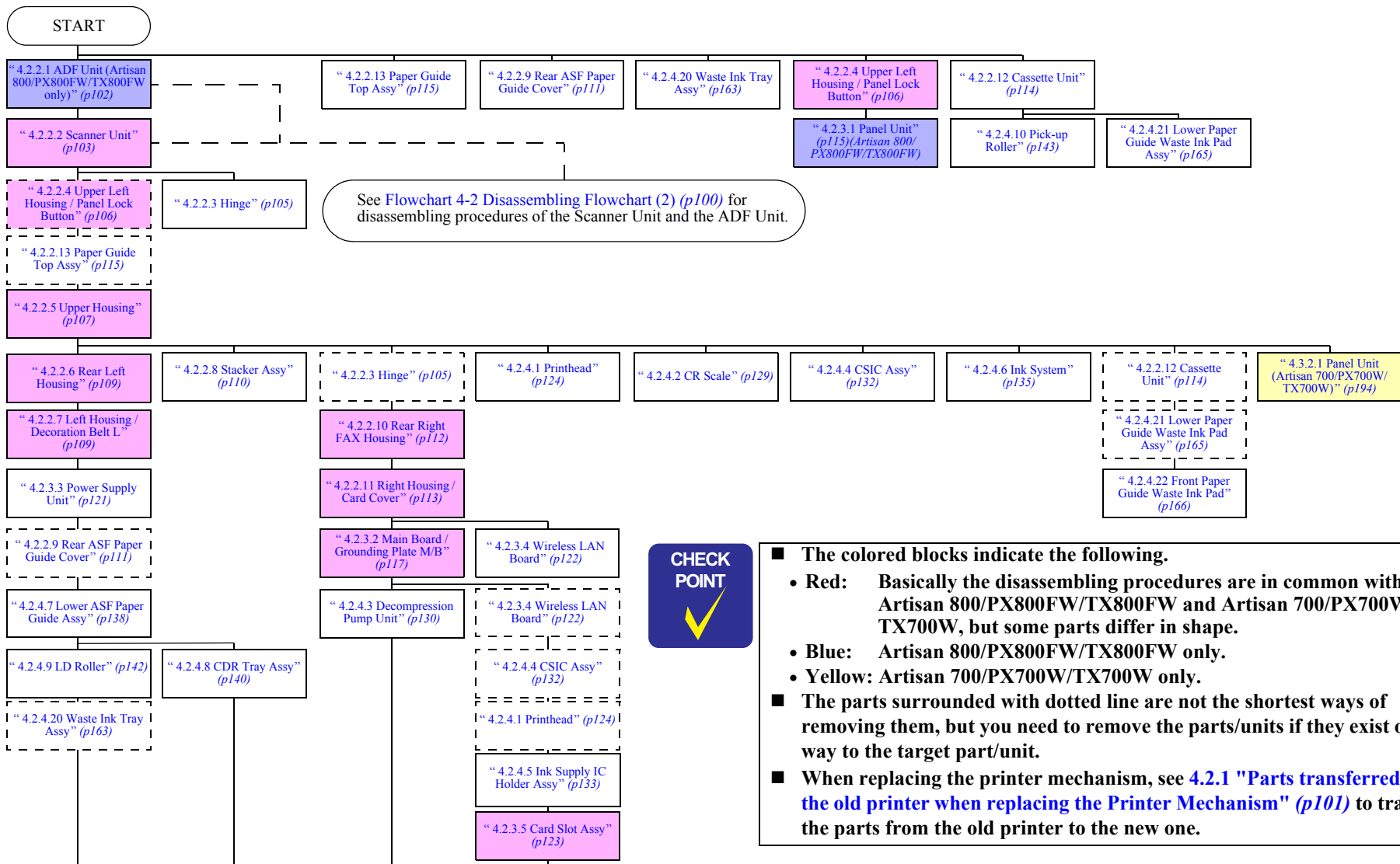
Parts name			Reference page
	Artisan 800/PX800FW/TX800FW	Artisan 700/PX700W/TX700W	
ADF Unit	ADF mechanism	No ADF mechanism	<ul style="list-style-type: none"> □ Artisan 800/PX800FW/TX800FW <ul style="list-style-type: none"> ■ 4.2.2.1 " ADF Unit (Artisan 800/PX800FW/TX800FW only) " (p.102)
Scanner Unit	The Document Cover and Housing are different depend on the ADF mechanism or not.		<ul style="list-style-type: none"> □ Artisan 800/PX800FW/TX800FW <ul style="list-style-type: none"> ■ 4.2.6 " Disassembly of the ADF Unit (Artisan 800/PX800FW/TX800FW only) " (p.174) ■ 4.2.5 " Disassembling Scanner Unit " (p.167) □ Artisan 700/PX700W/TX700W <ul style="list-style-type: none"> ■ 4.3.3.1 " Document Cover " (p.200) ■ 4.3.3.2 " Scanner Upper Housing (Artisan 700/PX700W/TX700W) " (p.201)
			
Panel Unit	7.8 inch touch panel 3.5 inch LCD	2.5 inch LCD (no touch panel)	<ul style="list-style-type: none"> □ Artisan 800/PX800FW/TX800FW <ul style="list-style-type: none"> ■ 4.2.3.1 " Panel Unit " (p.115) □ Artisan 700/PX700W/TX700W <ul style="list-style-type: none"> ■ 4.3.2.1 " Panel Unit (Artisan 700/PX700W/TX700W) " (p.194)

Table 4-3. Procedure Differences

Parts name			Reference page
	Artisan 800/PX800FW/TX800FW	Artisan 700/PX700W/TX700W	
Upper Housing Left Housing Rear Left Housing Upper Left Housing Right Housing Right Rear Housing	Housing is different. The numbers of the screws and positions are partially different. <div style="display: flex; justify-content: space-around; align-items: center;">   </div>		<input type="checkbox"/> Artisan 800/PX800FW/TX800FW <input checked="" type="checkbox"/> 4.2.2 " Removing the Housing " (p.102) <input type="checkbox"/> Artisan 700/PX700W/TX700W <input checked="" type="checkbox"/> 4.3.1 " Removing the Housing " (p.185)
Main Board	The specification of the Main Board is different as well as the positions of the connectors.		<input type="checkbox"/> Artisan 800/PX800FW/TX800FW <input checked="" type="checkbox"/> 4.2.3 " Removing the Circuit Board " (p.115)
FAX	FAX	No FAX	<input type="checkbox"/> Artisan 700/PX700W/TX700W <input checked="" type="checkbox"/> 4.3.2 " Removing the Circuit Board (Artisan 700/PX700W/TX700W) " (p.194)

4.2 Disassembly Procedures

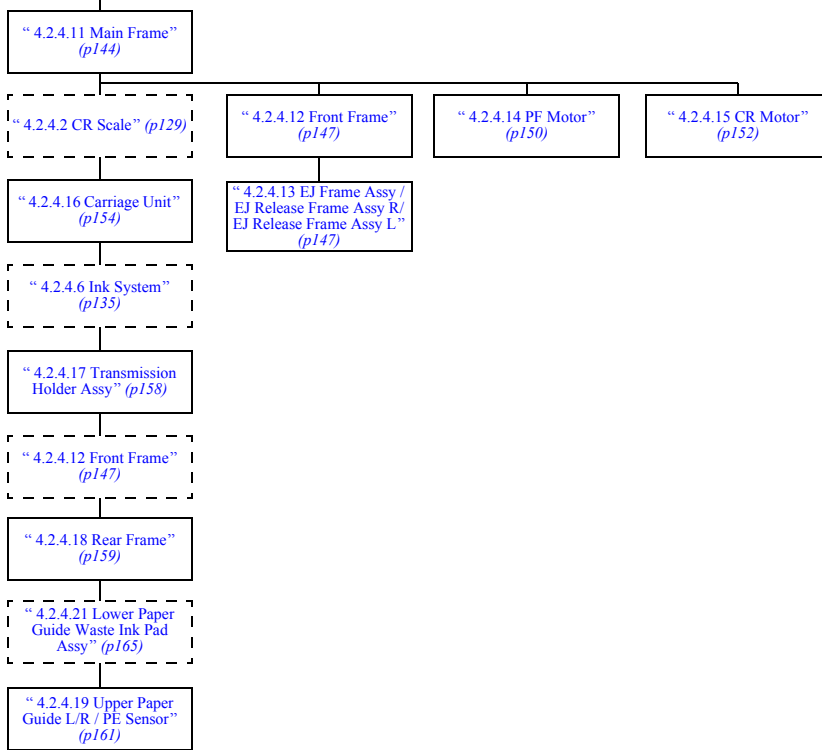
For disassembling each unit, refer to the pages in the following flowchart.



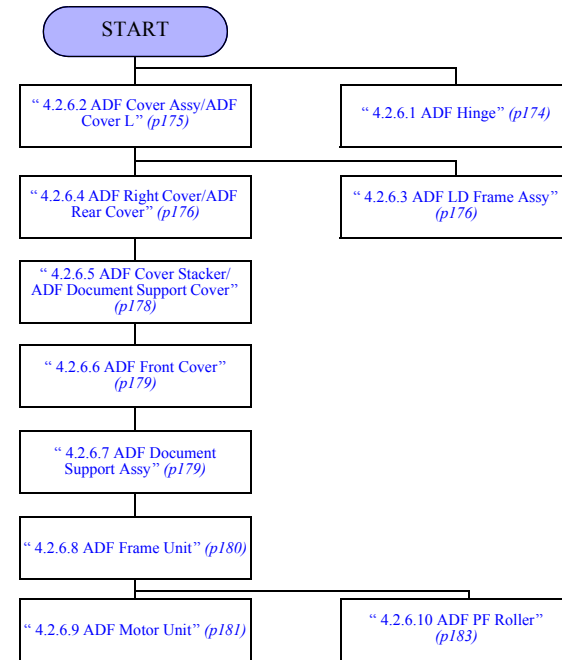
Flowchart 4-2 Disassembling Flowchart (2) (p100)

Flowchart 4-1. Disassembling Flowchart (1)

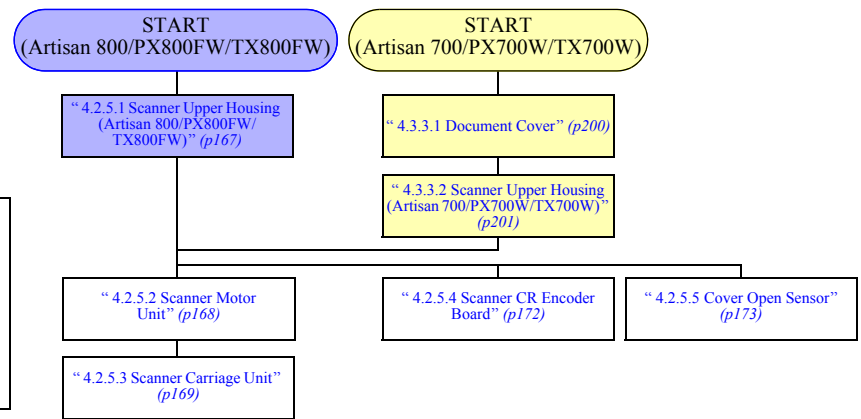
Flowchart 4-1 Disassembling Flowchart (1) (p99)



□ Disassembling the ADF Unit (Artisan 800/PX800FW/TX800FW only)



□ Disassembling the Scanner Unit



- The colored blocks indicate the following.
 - Blue: Artisan 800/PX800FW/TX800FW only.
 - Yellow: Artisan 700/PX700W/TX700W only.
- The parts surrounded with dotted line are not the shortest ways of removing them, but you need to remove the parts/units if they exist on the way to the target part/unit.

Flowchart 4-2. Disassembling Flowchart (2)

4.2.1 Parts transferred from the old printer when replacing the Printer Mechanism

When replacing the Printer Mechanism specified as ASP parts with a new one, transfer the parts in the list below from the old printer to the new one.



When removing/installing the Printhead in the process of replacing the Printer Mechanism, make sure to perform the related work in “4.2.4.1 Printhead (p.124)”

Parts to replace	
Artisan 800/PX800FW/TX800FW	Artisan 700/PX700W/TX700W
4.2.2.1 " ADF Unit (Artisan 800/PX800FW/ TX800FW only) " (p.102)	---
4.2.2.2 " Scanner Unit " (p.103)	4.3.1.1 " Scanner Unit (Artisan 700/PX700W/ TX700W) " (p.185)
4.2.2.4 " Upper Left Housing / Panel Lock Button " (p.106)	4.3.1.2 " Upper Left Housing (Artisan 700/ PX700W/TX700W) " (p.187)
4.2.2.5 " Upper Housing " (p.107)	4.3.1.3 " Upper Housing (Artisan 700/PX700W/ TX700W) " (p.188)
4.2.2.6 " Rear Left Housing " (p.109)	4.3.1.4 " Rear Left Housing (Artisan 700/PX700W/ TX700W) " (p.190)
4.2.2.7 " Left Housing / Decoration Belt L " (p.109)	4.3.1.5 " Left Housing/Decoration Belt L (Artisan 700/PX700W/TX700W) " (p.191)
4.2.2.10 " Rear Right FAX Housing " (p.112)	4.3.1.6 " Rear Right Housing (Artisan 700/ PX700W/TX700W) " (p.192)
4.2.2.11 " Right Housing / Card Cover " (p.113)	4.3.1.7 " Right Housing/Card Cover (Artisan 700/ PX700W/TX700W) " (p.193)
4.2.3.1 " Panel Unit " (p.115)	4.3.2.1 " Panel Unit (Artisan 700/PX700W/ TX700W) " (p.194)
4.2.3.2 " Main Board / Grounding Plate M/B " (p.117)	4.3.2.2 " Main Board/Grounding Plate M/B (Artisan 700/PX700W/TX700W) " (p.196)
4.2.3.5 " Card Slot Assy " (p.123)	4.3.2.3 " Card Slot Assy (Artisan 700/PX700W/ TX700W) " (p.199)
4.2.2.3 " Hinge " (p.105)	
4.2.2.9 " Rear ASF Paper Guide Cover " (p.111)	
4.2.2.12 " Cassette Unit " (p.114)	
4.2.2.13 " Paper Guide Top Assy " (p.115)	

Parts to replace	
Artisan 800/PX800FW/TX800FW	Artisan 700/PX700W/TX700W
4.2.3.3 " Power Supply Unit " (p.121)	
4.2.3.4 " Wireless LAN Board " (p.122)	
4.2.4.1 " Printhead " (p.124)	
4.2.4.3 " Decompression Pump Unit " (p.130)	
4.2.4.4 " CSIC Assy " (p.132)	
4.2.4.7 " Lower ASF Paper Guide Assy " (p.138)	
4.2.4.8 " CDR Tray Assy " (p.140)	
4.2.4.20 " Waste Ink Tray Assy " (p.163)	

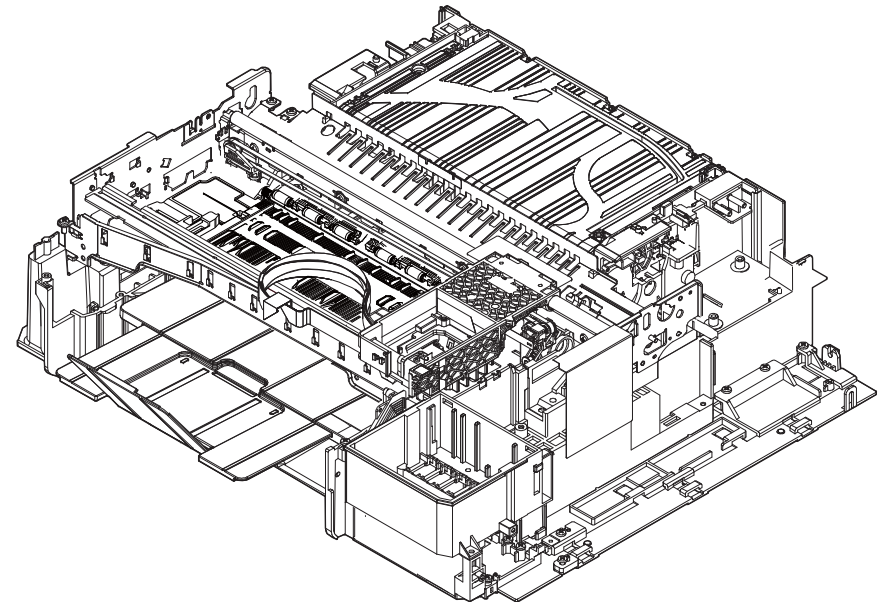


Figure 4-1. Printer Mechanism

4.2.2 Removing the Housing

4.2.2.1 ADF Unit (Artisan 800/PX800FW/TX800FW only)

- Parts/Components need to be removed in advance:

None

- Removal procedure

1. Open the Scanner Unit.

**CHECK
POINT**



The harness cover clamp needs to be cut when removing, and cannot be reused. When installing the Cable Cover, replace it with a new one.

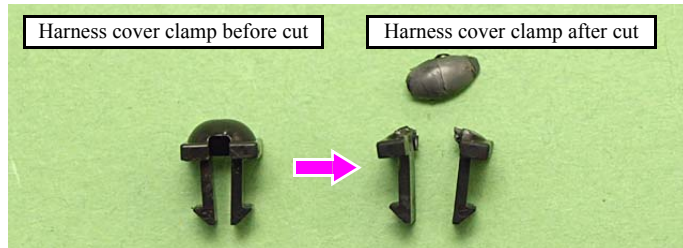


Figure 4-2. Damaged stopper

2. Cut the harness cover clamp with a nipper as shown in Fig. 4-3 and remove the harness cover clamp.
3. Slide the Cable Cover to the rear of the printer by pushing the point A of the Cable Cover to release the hooks (x4) and ribs (x2), and remove the Cable Cover.

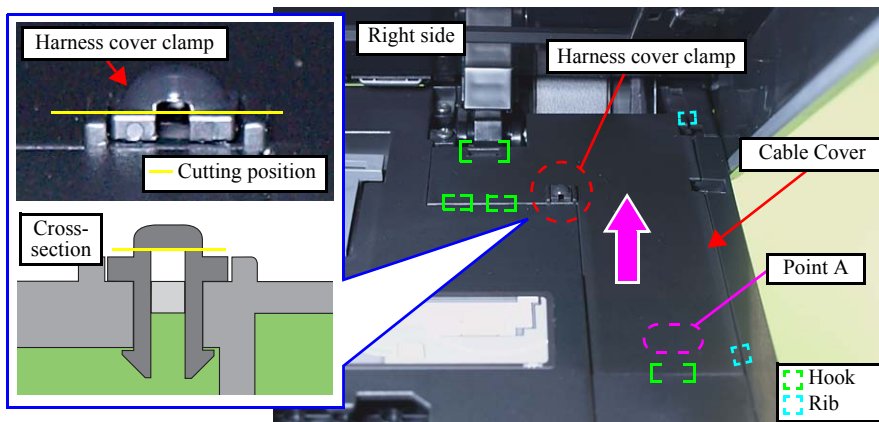


Figure 4-3. Removing the Cable Cover

4. Disconnect the ADF Motor Cable and ADF Sensor Cable from the connectors on the Main Board. (See Fig. 4-4.)
5. Pull out the terminal of the Grounding Wire from the fixing rib of the frame.

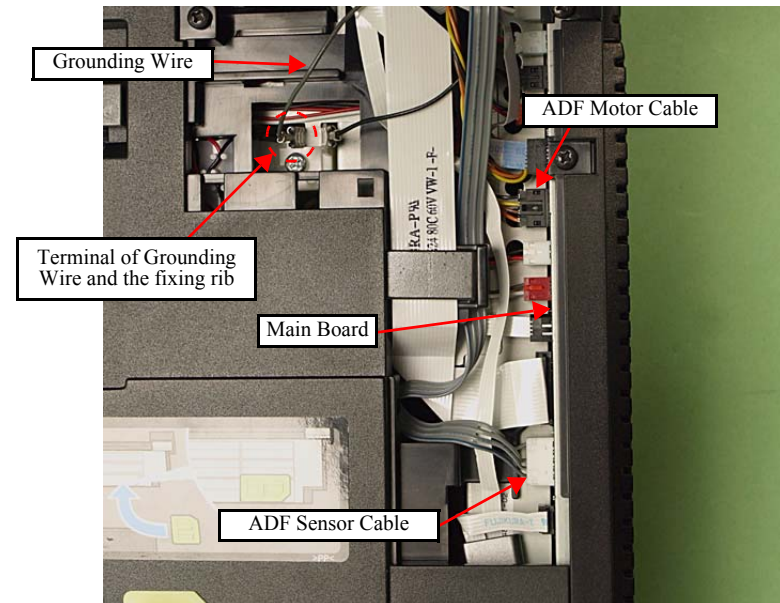


Figure 4-4. Removing the ADF Unit (1)

CAUTION

Take care not to let the cables get caught by the housing of the Scanner Unit.

6. Release the hooks (x2) of the Hinge and hook (x1) of the ADF Cable Cover from the rear side while holding the center of the ADF Unit. (See Fig. 4-5.)
7. Remove the ADF Unit while pulling out the ADF Motor Cable, the ADF Sensor Cable and the Grounding Wire from the hole of the Scanner Unit.

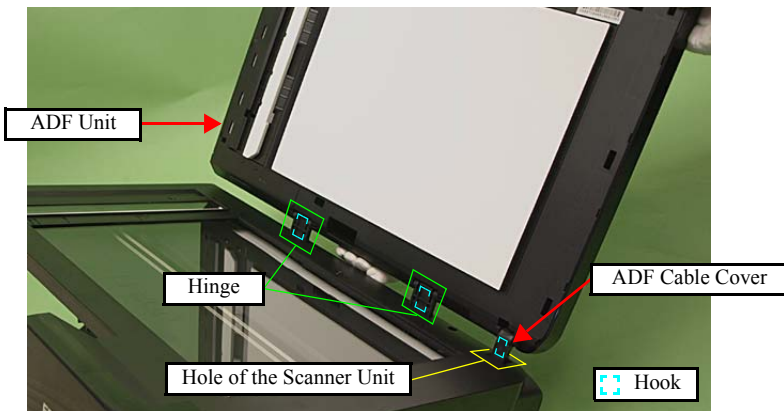


Figure 4-5. Removing the ADF Unit (2)

REASSEMBLY

- Insert the terminal of the Grounding Wire to the end of the rib of the Frame. (See Fig. 4-4.)
- For routing cables, see 4.4 "Routing FFC/cables" (p202).
- When installing the Cable Cover, secure it with a new Harness Cover Clamp. (See Fig. 4-3.)

4.2.2.2 Scanner Unit

CHECK POINT

The disassembly/reassembly procedures of Artisan 700/PX700W/TX700W differ from those of Artisan 800/PX800FW/TX800FW. See 4.3.1.1 "Scanner Unit (Artisan 700/PX700W/TX700W)" (p185) for the procedures.

- Parts/Components need to be removed in advance:
ADF Unit (Artisan 800/PX800FW/TX800FW only)
- Removal procedure
 1. Open the Scanner Unit.
 2. Disconnect the Scanner FFCs (x3) together with the Ferrite Cores (x2) from the Main Board. (See Fig. 4-6.)
 3. Pull out the terminal of the Grounding Wire from the fixing rib of the frame.

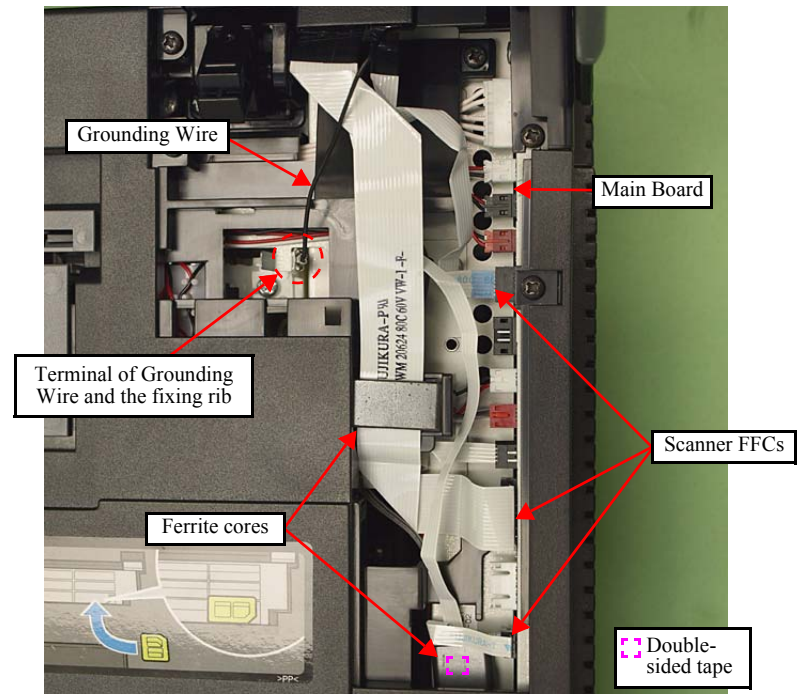


Figure 4-6. Removing the Scanner Unit (1)



Do not open/close the Scanner Unit with the screws removed to avoid damage of the Scanner Unit Hinge.

- Remove the screw (x1) that secures the Scanner Unit.

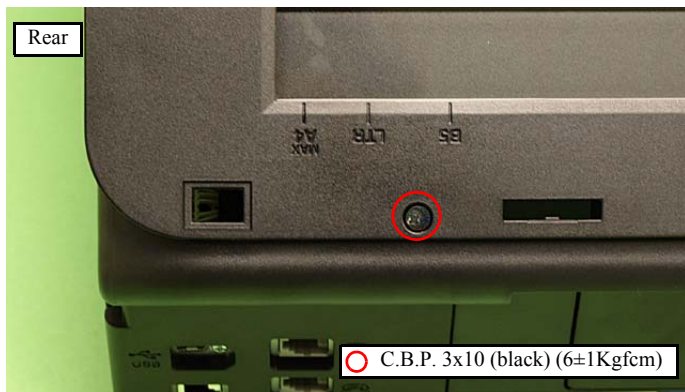


Figure 4-7. Removing the Scanner Unit (2)

- Lift the Hinge on the right side in the direction of the arrow (1) and slide the Scanner Unit in the direction of the arrow (2), and remove it.

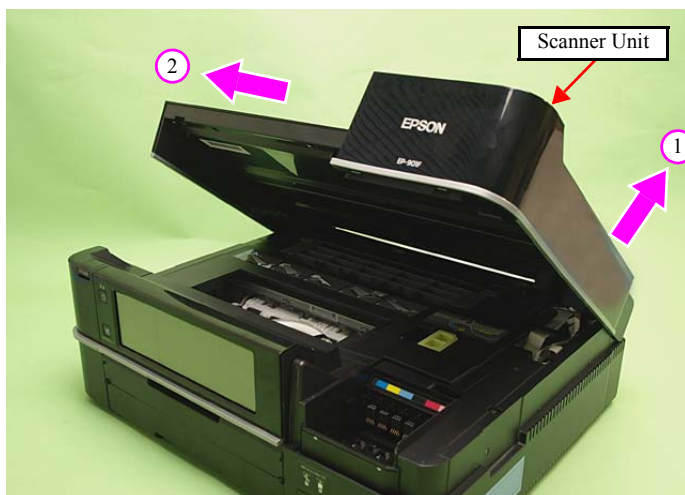


Figure 4-8. Removing the Scanner Unit (3)



- When installing the Scanner Unit, follow the procedure below.
 - Align and insert the dowel of the Scanner Unit to the positioning hole of the printer (Left inside).
 - Align and insert the rib of the Scanner Unit to the groove of the Hinge.

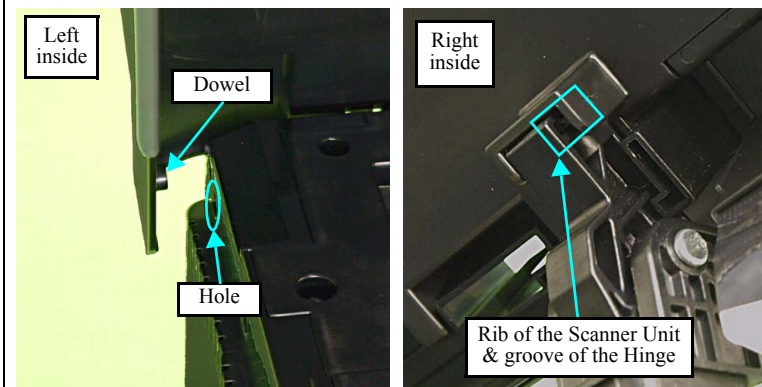


Figure 4-9. Installing the Scanner Unit (1)

- While aligning the screw holes with the Scanner Unit open, secure them temporarily with the screw (x1) shown in Fig. 4-7. (It is recommended to prepare a pillow-shaped supporter to keep this position.)



Figure 4-10. Installing the Scanner Unit (2)

(Continued to the next page.)

REASSEMBLY



4. Close the Scanner Unit.
5. Tighten the screw (x1) finally after making sure that there is no gap between the Scanner Unit and the printer.

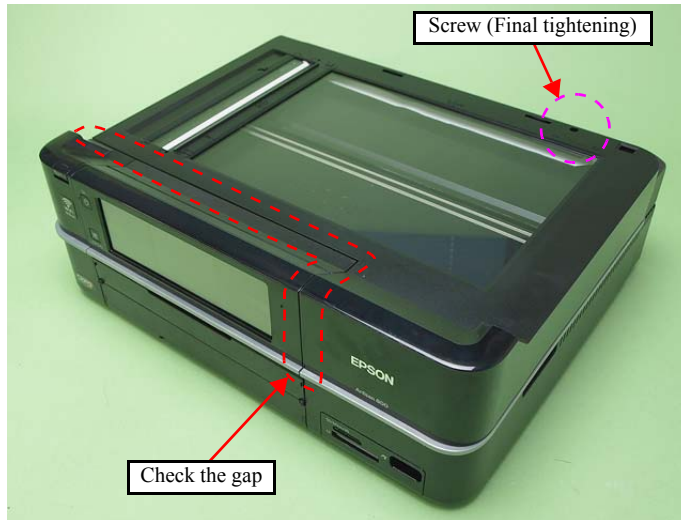


Figure 4-11. Installing the Scanner Unit

- Make sure to insert the terminal of the Grounding wire to the fixing rib of the Frame. (See Fig. 4-6.)
- For the routing of the FFCs, see 4.4 "Routing FFC/cables" (p202).
- When installing the Cable Cover, secure it with a new Harness Cover Clamp. (See Fig. 4-3.)

ADJUSTMENT
REQUIRED

After removing/replacing the Scanner Unit, make the specified adjustments. (See Chapter 5 "ADJUSTMENT".)

4.2.2.3 Hinge

- Parts/Components need to be removed in advance:
ADF Unit (Artisan 800/PX800FW/TX800FW only)/Scanner Unit
- Removal procedure
 1. Remove the screw (x1) that secures the Hinge and remove the Hinge.

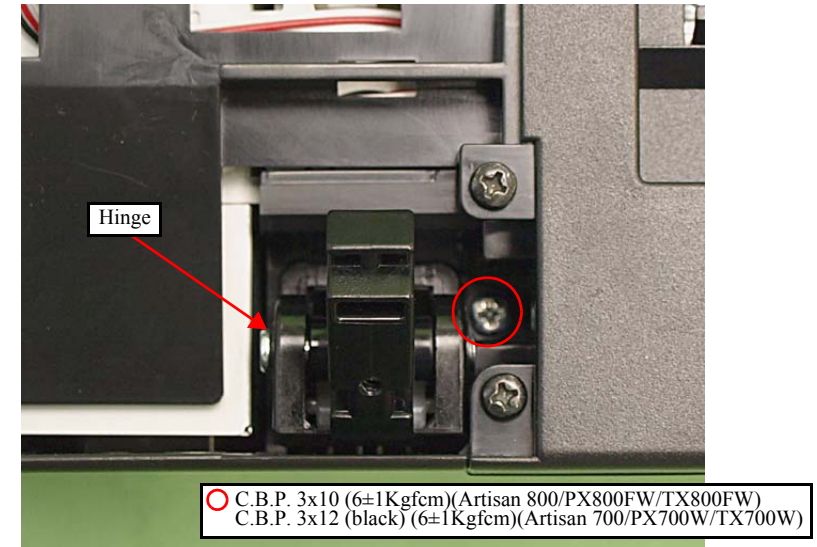


Figure 4-12. Removing the Hinge

4.2.2.4 Upper Left Housing / Panel Lock Button

CHECK
POINT



The disassembly/reassembly procedures of Artisan 700/PX700W/TX700W differ from those of Artisan 800/PX800FW/TX800FW. See 4.3.1.2 "Upper Left Housing (Artisan 700/PX700W/TX700W)" (p187) for the procedures.

- Parts/Components need to be removed in advance:

None

- Removal procedure

1. Remove the screw (x1) that secures the Upper Left Housing.
2. Release the hooks (x2) and ribs (x2) of the Upper Left Housing and remove the Upper Left Housing.

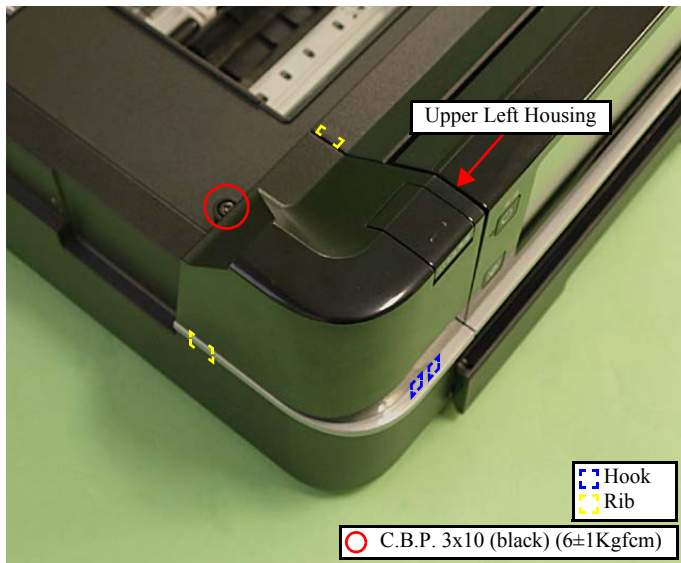


Figure 4-13. Removing the Upper Left Housing

3. Remove the Panel Lock Button.

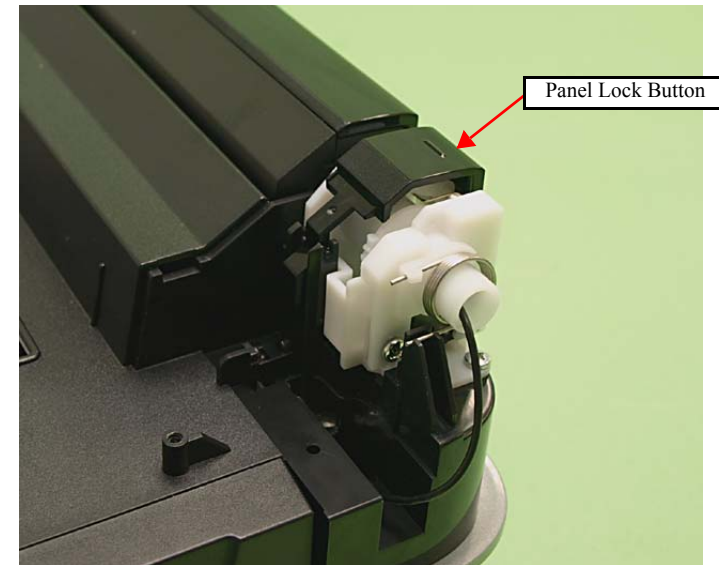


Figure 4-14. Removing the Panel Lock Button

4.2.2.5 Upper Housing

CHECK
POINT



The disassembly/reassembly procedures of Artisan 700/PX700W/TX700W differ from those of Artisan 800/PX800FW/TX800FW. See 4.3.1.3 "Upper Housing (Artisan 700/PX700W/TX700W)" (p188) for the procedures.

- Parts/Components need to be removed in advance:
ADF Unit (Artisan 800/PX800FW/TX800FW only)/Scanner Unit/Upper Left Housing/Paper Guide Top Assy
- Removal procedure

CAUTION



The Grounding Wire is attached to the frame with a screw. Be careful not to deform the Frame when removing the screw.

1. Remove the screw (x1) and release the Grounding Wire.

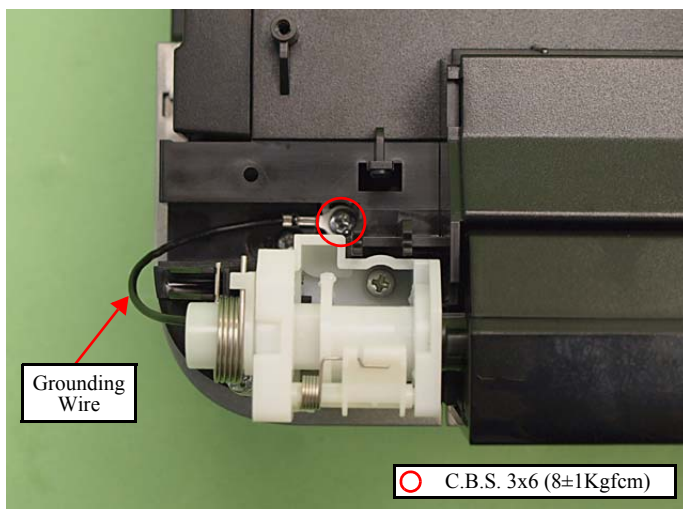


Figure 4-15. Releasing the Grounding Wire

2. Release the hooks (x2) and ribs (x3) of the Front Harness Cover with the flathead screwdriver, and remove the Front Harness Cover from the Upper Housing.

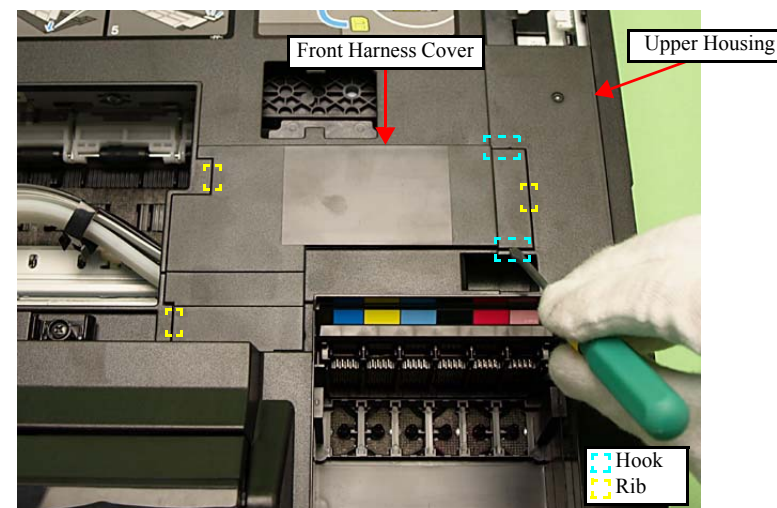


Figure 4-16. Removing the Upper Housing (1)

3. Remove the screws (x9) that secure the Upper Housing. (See Fig. 4-17.)
4. Release the ribs (x4) and hooks (x2) of the Upper Housing.

6. Remove the Panel Unit from the Upper Housing. (See 4.2.3.1 "Panel Unit" (p115).)

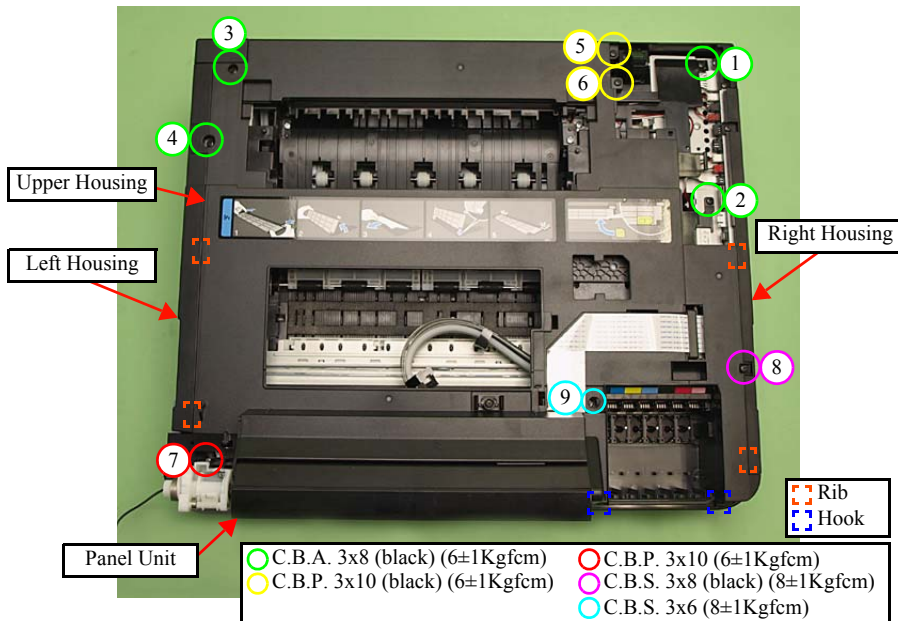


Figure 4-17. Removing the Upper Housing (2)

5. Lift the Upper Housing slightly and disconnect the Panel FFC from the Main Board, and remove the Upper Housing together with the Panel Unit.

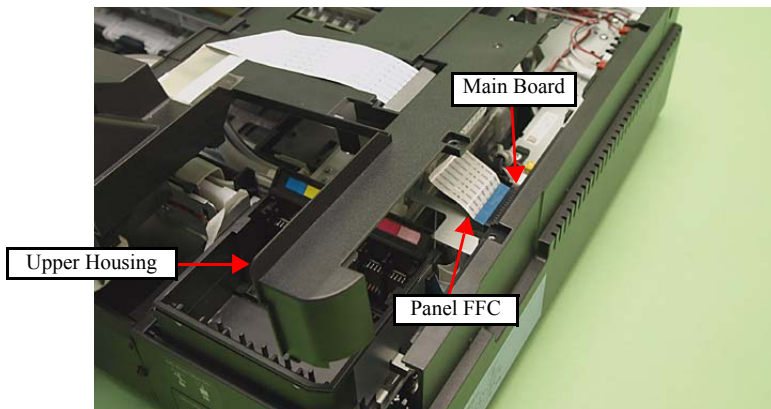


Figure 4-18. Removing the Upper Housing (3)



- Insert the ribs (x4) of the Upper Housing to the inside of the Housing L/R when installing the Upper Housing. (See Fig. 4-17.)
- Tighten the screws in the order shown in Fig. 4-17.
- When installing the Front Harness Cover, insert the ribs (x3) of the Front Harness Cover to the Upper Housing, and secure them with the hooks (x2). (See Fig. 4-16.)



After removing/replacing the Upper Housing, make the specified adjustments. (See Chapter 5 "ADJUSTMENT".)

4.2.2.6 Rear Left Housing

CHECK
POINT



The disassembly/reassembly procedures of Artisan 700/PX700W/TX700W differ from those of Artisan 800/PX800FW/TX800FW. See 4.3.1.4 "Rear Left Housing (Artisan 700/PX700W/TX700W)" (p190) for the procedures.

- Parts/Components need to be removed in advance:

ADF Unit (Artisan 800/PX800FW/TX800FW only)/Scanner Unit/Upper Left Housing/Paper Guide Top Assy/Upper Housing

- Removal procedure

1. Remove the screws (x2) that secure the Rear Left Housing and remove the Rear Left Housing.

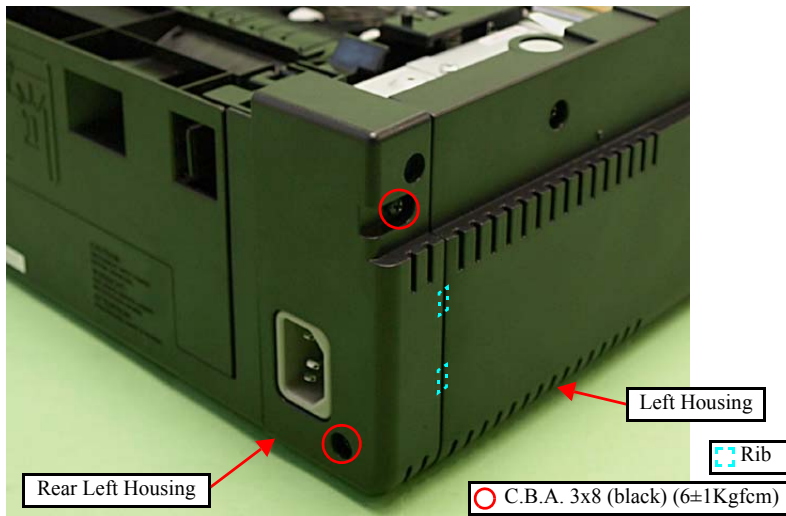


Figure 4-19. Removing the Rear Left Housing

REASSEMBLY



When installing the Rear Left Housing, insert the ribs (x2) of the Rear Left Housing to the inside of the Left Housing. (See Fig. 4-19.)

4.2.2.7 Left Housing / Decoration Belt L

CHECK
POINT



The disassembly/reassembly procedures of Artisan 700/PX700W/TX700W differ from those of Artisan 800/PX800FW/TX800FW. See 4.3.1.5 "Left Housing/Decoration Belt L (Artisan 700/PX700W/TX700W)" (p191) for the procedures.

- Parts/Components need to be removed in advance:

ADF Unit (Artisan 800/PX800FW/TX800FW only)/Scanner Unit/Upper Left Housing/Paper Guide Top Assy/Upper Housing/Rear Left Housing

- Removal procedure

1. Remove the screw (x1) that secures the Decoration Belt and remove the Decoration Belt from the Left Housing. (See Fig. 4-20.)
2. Remove the screw (x1) that secures the Left Housing.

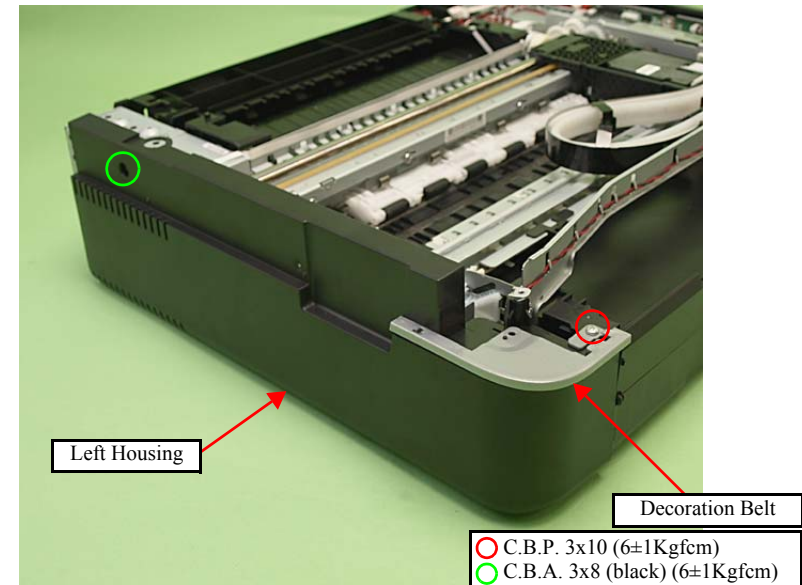


Figure 4-20. Removing the Left Housing / Decoration Belt L (1)

CAUTION

So as to make description easier, the printer in the photographs is placed vertically in the following steps. Be careful about ink spilling if the printer is tilted in practical operation.

3. Release the hooks (x3) on the bottom and dowel (x1) on the front side of the Left Housing, and remove the Left Housing in the direction of the arrow.

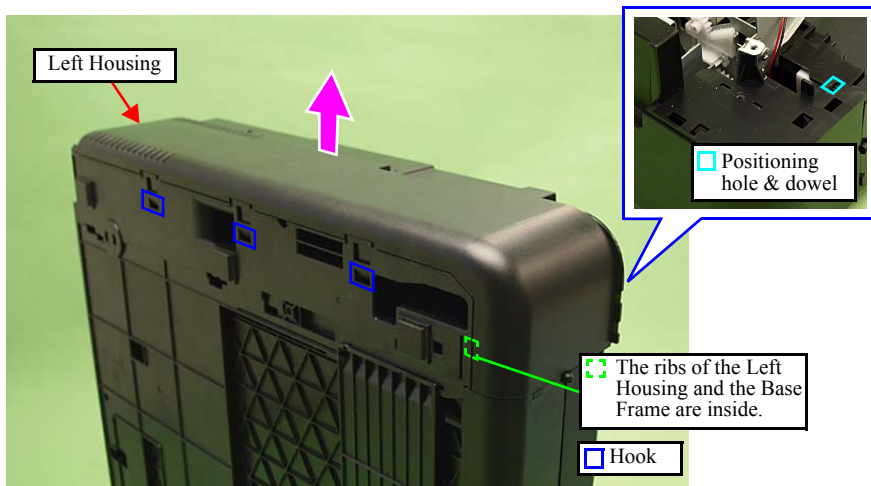


Figure 4-21. Removing the Left Housing / Decoration Belt L (2)

REASSEMBLY

- Align and insert the rib in the front inside of the Left Housing to the inside of the rib of the Base Frame.

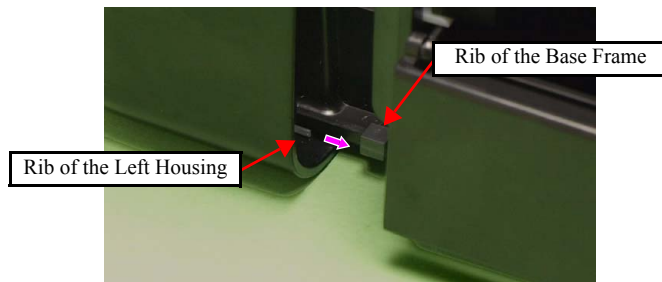


Figure 4-22. Installing the Left Housing

- Align the positioning hole of the Left Housing with the dowel of the Base Frame. (See Fig. 4-21.)

4.2.2.8 Stacker Assy

- Parts/Components need to be removed in advance:
ADF Unit (Artisan 800/PX800FW/TX800FW only)/Scanner Unit/Upper Left Housing/Paper Guide Top Assy/Upper Housing
- Removal procedure
 1. Pull the Stacker Assy.
 2. Bend the center of the Stacker Assy and release the dowels (x4) from the grooves of the Base Frame, and remove the Stacker Assy.

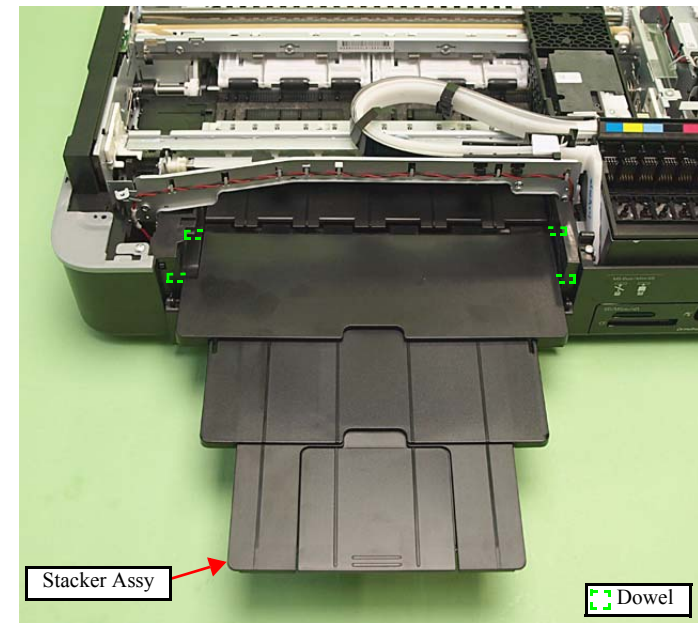


Figure 4-23. Removing the Stacker Assy

REASSEMBLY

Make sure that the antistatic seals (x2) on the bottom of the Stacker Assy are correctly attached.

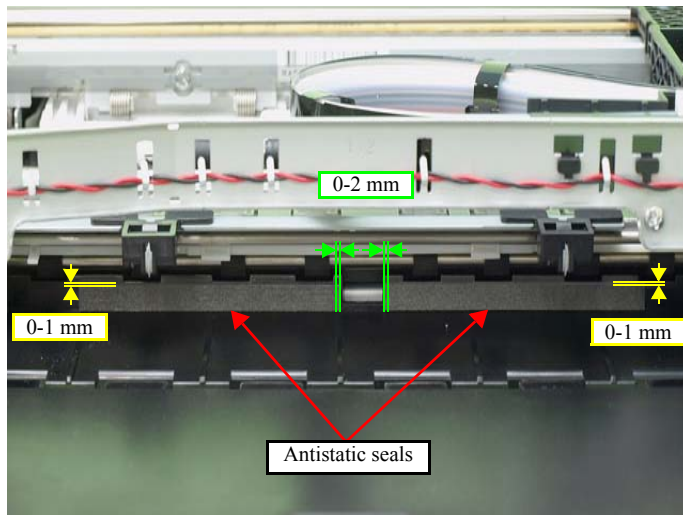


Figure 4-24. Attachment position of the antistatic seal

4.2.2.9 Rear ASF Paper Guide Cover

- Parts/Components need to be removed in advance:
 - None
- Removal procedure
 1. Release the hook (x1) and remove the Rear ASF Paper Guide Cover.



Figure 4-25. Removing the Rear ASF Paper Guide Cover

REASSEMBLY

Insert the ribs (x2) of the Rear ASF Paper Guide Cover to the inside of the Housing, and secure it with the hook (x1).

4.2.2.10 Rear Right FAX Housing

CHECK POINT


The disassembly/reassembly procedures of Artisan 700/PX700W/TX700W differ from those of Artisan 800/PX800FW/TX800FW. See 4.3.1.6 "Rear Right Housing (Artisan 700/PX700W/TX700W)" (p192) for the procedures.

- Parts/Components need to be removed in advance:
ADF Unit (Artisan 800/PX800FW/TX800FW only)/Scanner Unit/Upper Left Housing/Paper Guide Top Assy/Upper Housing/Hinge
- Removal procedure
 1. Remove the screws (x3) that secure the Rear Right FAX Housing.

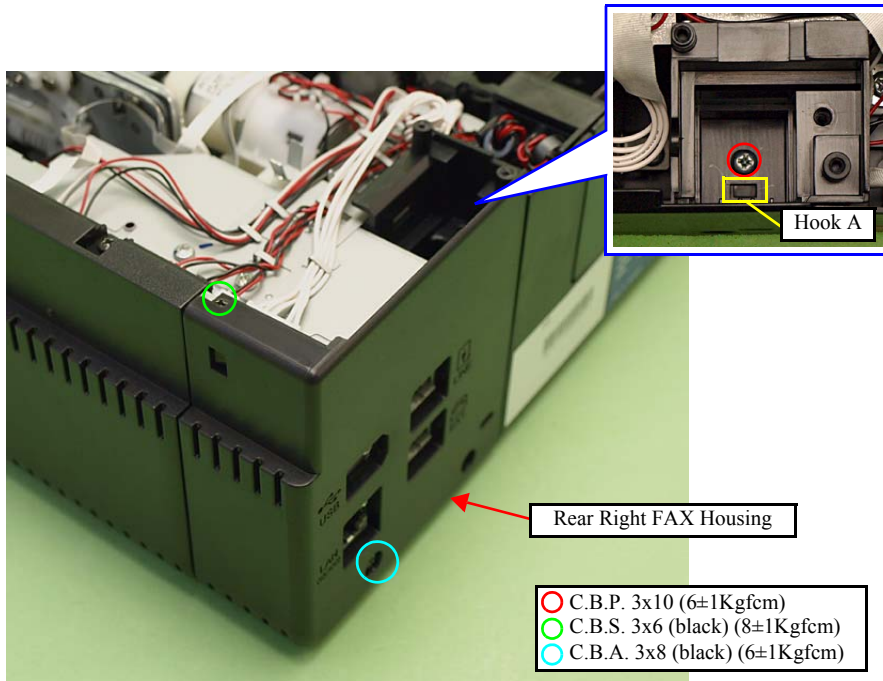


Figure 4-26. Removing the Rear Right FAX Housing (1)

2. Release the ribs (x2) and hook B on the right side, and also release the point A, then remove the Rear Right FAX Housing by lifting it in the direction of the arrow. (See Fig. 4-26, Fig. 4-27.)

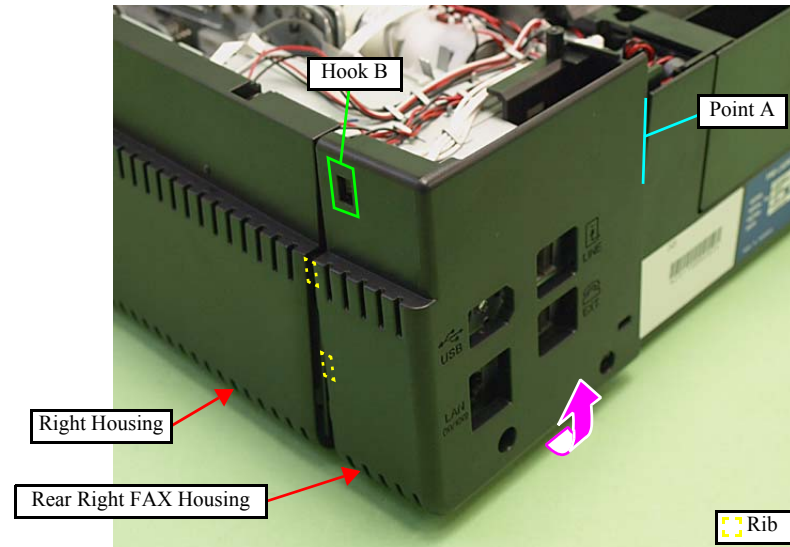


Figure 4-27. Removing the Rear Right FAX Housing (2)

REASSEMBLY


- When installing the Rear Right FAX Housing, insert the ribs (x2) of the Rear Right FAX Housing to the inside of the Right Housing. (See Fig. 4-27.)
- When installing the Rear Right FAX Housing, align the point A of the Rear Right FAX Housing with the inside of the Base Frame. (See Fig. 4-27.)

4.2.2.11 Right Housing / Card Cover

CHECK
POINT



The disassembly/reassembly procedures of Artisan 700/PX700W/TX700W differ from those of Artisan 800/PX800FW/TX800FW. See 4.3.1.7 "Right Housing/Card Cover (Artisan 700/PX700W/TX700W)" (p193) for the procedures.

- Parts/Components need to be removed in advance:

ADF Unit (Artisan 800/PX800FW/TX800FW only)/Scanner Unit/Upper Left Housing/Paper Guide Top Assy/Upper Housing/Hinge/Rear Right FAX Housing

- Removal procedure

1. Remove the screws (x2) that secure the Right Housing.

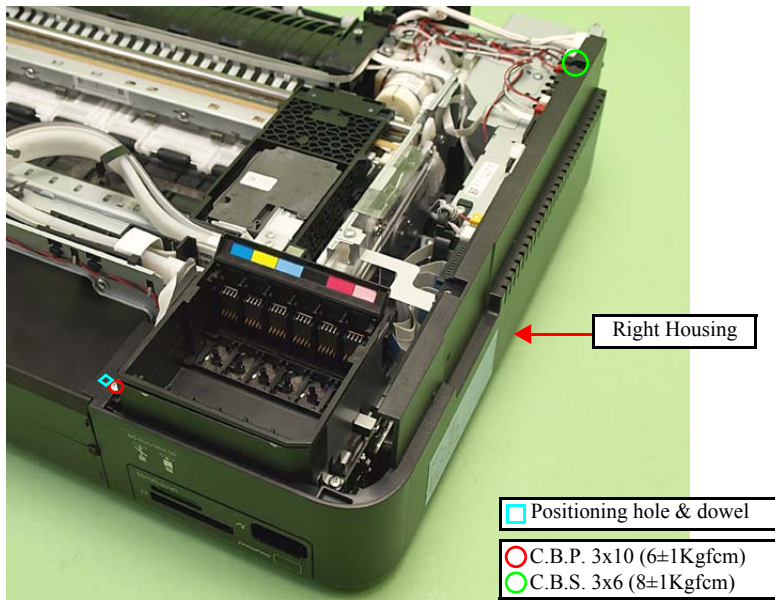


Figure 4-28. Removing the Right Housing/Card Cover (1)



When removing the Right Housing, be careful not to let the Card Cover interfere with the Card Slot Assy or the Card Cover may be damaged.

2. Release the dowel (x1) of the front side (See Fig. 4-28.) and hooks (x3) on the bottom of the Right Housing, and remove the Right Housing.



Figure 4-29. Removing the Right Housing/Card Cover (2)

3. Release the hooks (x2) from the back of the Right Housing and remove the Card Cover.

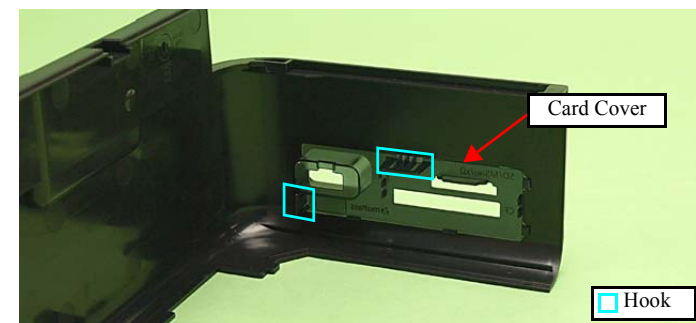


Figure 4-30. Removing the Right Housing/Card Cover (3)

REASSEMBLY



- Align and insert the positioning hole of the Right Housing to the dowel of the Base Frame. (See Fig. 4-28.)
- Attach the Card Cover after installing the Right Housing to the Printer.
- When attaching the Card Cover, insert the ribs (x2) of the Card Cover to the inside of the Right Housing, and secure it with the hooks (x2).

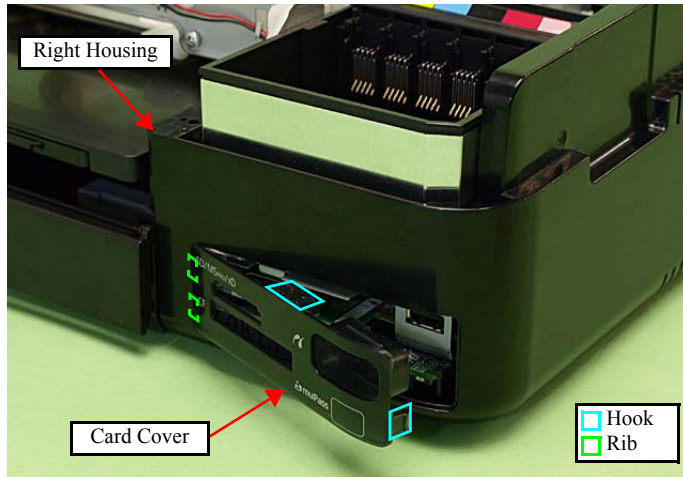


Figure 4-31. Attaching the Card Cover

4.2.2.12 Cassette Unit

- Parts/Components need to be removed in advance:
 - None
- Removal procedure
 1. Hold and pull the grip under the Cassette Unit, and remove the Cassette Unit.



Figure 4-32. Removing the Cassette Unit

REASSEMBLY



- When replacing the cork A/B, wipe the attaching position with ethanol, and attach it without any gap at the point A.
- When attaching the cork B, align the cutout to the place shown in Fig. 4-33.

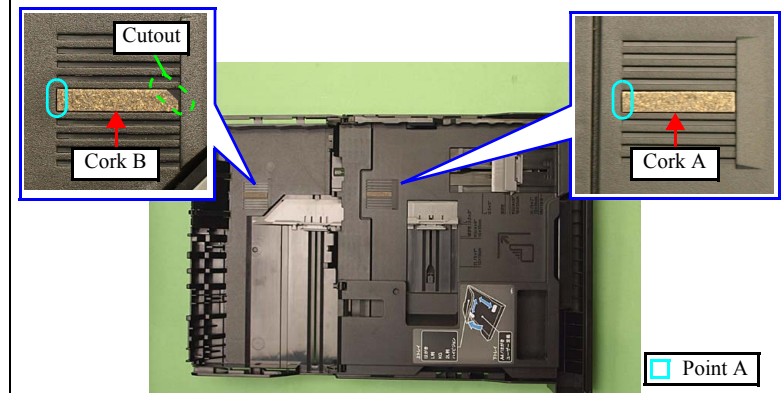


Figure 4-33. Attaching the cork

4.2.2.13 Paper Guide Top Assy

- Parts/Components need to be removed in advance:
 - None
- Removal procedure
 1. Open the Scanner Unit.
 2. Release the hooks (x2) and remove the Paper Guide Top Assy.

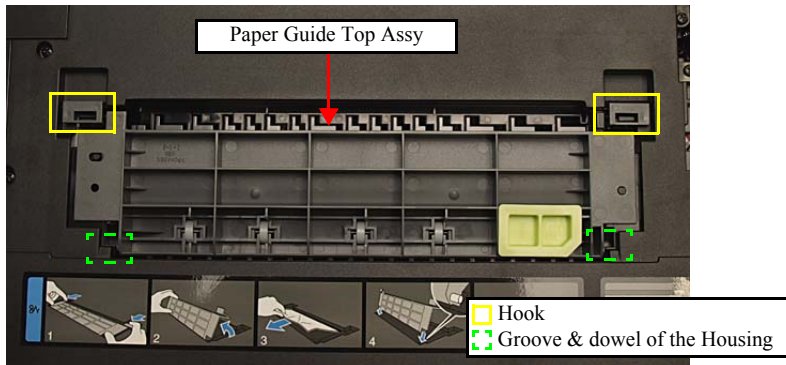


Figure 4-34. Removing the Paper Guide Top Assy

REASSEMBLY



Align and insert the dowels (x2) of the Paper Guide Top Assy to the grooves of the Housing, and secure it with the hooks (x2). (See Fig. 4-34.)

4.2.3 Removing the Circuit Board

4.2.3.1 Panel Unit

CHECK POINT



The disassembly/reassembly procedures of Artisan 700/PX700W/TX700W differ from those of Artisan 800/PX800FW/TX800FW. See 4.3.2.1 "Panel Unit (Artisan 700/PX700W/TX700W)" (p194) for the procedures.

- Parts/Components need to be removed in advance:
 - Upper Left Housing
- Removal procedure
 1. Remove the Grounding Wire. (See 4.2.2.5 *Upper Housing Step1* (p107).)
 2. Remove the Panel Spring (x1). (See Fig. 4-35.)
 3. Remove the screws (x2) that secure the Ratchet Holder Assy.

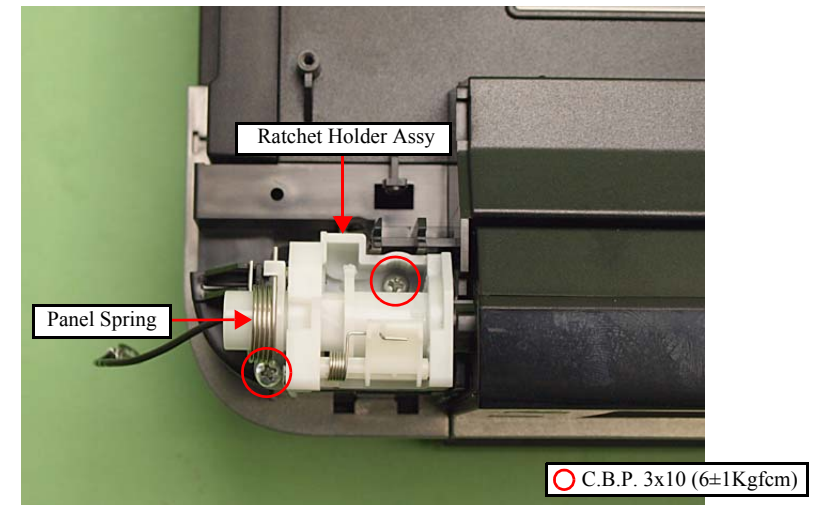


Figure 4-35. Removing the Ratchet Holder Assy (1)

4. Slide the Ratchet Holder Assy to the left, and release the rib A. (See Fig. 4-36.)
5. Slide the Ratchet Holder Assy to the front to remove it from the Upper Housing, and remove it from the Panel Unit.

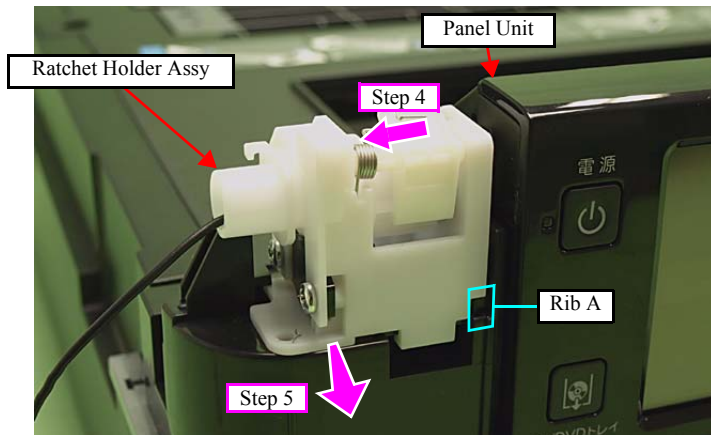


Figure 4-36. Removing the Ratchet Holder Assy (2)

6. Release the hooks (x3) of the Front Panel Unit Cover. (See Fig. 4-37.)
7. Slide the Upper Panel Cover in the direction of the arrow to release the hooks (x6), and remove the Upper Panel Cover.

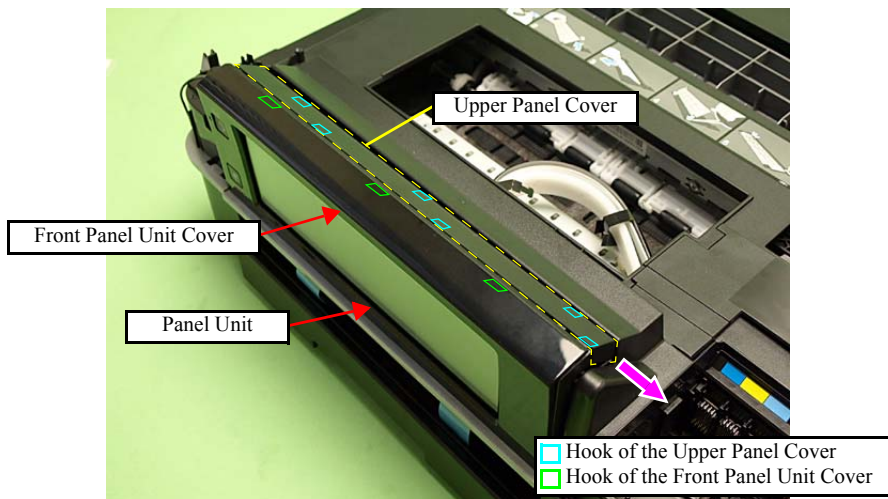


Figure 4-37. Removing the Panel Unit (1)

8. Disconnect the Panel FFC from the connector of the Panel Unit. (See Fig. 4-38.)
9. Remove the screw (x1) that secures the Panel Unit and remove the Panel Unit from the Upper Housing.

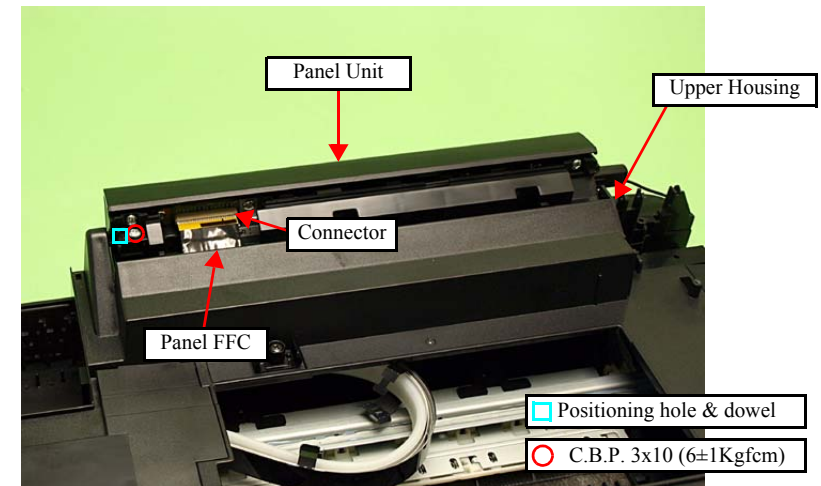


Figure 4-38. Removing the Panel Unit (2)



- Align and insert the dowel of the Right Hinge to the positioning hole of the Panel Unit. (See Fig. 4-38.)
- Insert the rib A of the Ratchet Holder Assy to the position shown in Fig. 4-36. (See Fig. 4-36.)



After removing/replacing the Panel Unit, make the specified adjustments. (See Chapter 5 "ADJUSTMENT".)

4.2.3.2 Main Board / Grounding Plate M/B



The disassembly/reassembly procedures of Artisan 700/PX700W/TX700W differ from those of Artisan 800/PX800FW/TX800FW. See 4.3.2.2 "Main Board/Grounding Plate M/B (Artisan 700/PX700W/TX700W)" (p196) for the procedures.



When printing the CDR, the CDR Tray feed amount is adjusted with compensation considering the deterioration of the CDR Tray, and the correction level is determined by the number of printed CDRs. If the data on the EEPROM can not be copied when replacing the Main Board, banding may occur while printing CDR due to improper corrections caused because the data of the number of printed CDRs can not be transferred. When this happens, replace the CDR Tray Assy with a new one together with the Main Board. (See 4.2.4.8 "CDR Tray Assy" (p140).)

- Parts/Components need to be removed in advance:
 - ADF Unit (Artisan 800/PX800FW/TX800FW only)/Scanner Unit/Upper Left Housing/Paper Guide Top Assy/Upper Housing/Hinge/Rear Right FAX Housing/Right Housing
- Removal procedure
 1. Disconnect all the cables and FFCs from the connectors on the Main Board.

Table 4-4. Connectors on the Main Board

CN No.	Cable/FFC	Connector Color	Number of pins	
			Artisan 800/ PX800FW/ TX800FW	Artisan 700/ PX700W/ TX700W
CN1	Head FFC	--	14	
CN2	Head FFC	--	14	
CN3	Head FFC	--	14	
CN4	Head FFC	--	14	
CN5	CSIC FFC	--	13	
CN6	CR Encoder FFC	--	7	
CN7	SUB FFC	--	9	
CN8	PF Encoder FFC	--	4	

Table 4-4. Connectors on the Main Board

CN No.	Cable/FFC	Connector Color	Number of pins	
			Artisan 800/ PX800FW/ TX800FW	Artisan 700/ PX700W/ TX700W
CN9	PE Sensor Cable	White	3	
CN10	Scanner Cover Open Sensor FFC	--	4	
CN12	Photo Tray Sensor Cable	Yellow	2	
CN13	Duplex Unit Sensor Cable	White	2	
CN14	CDR Tray Sensor Cable	Red	2	
CN19	Plunger Cable	Black	2	
CN21	CR Motor Cable	Black	2	
CN22	PF Motor Cable	White	2	
CN24	Decompression Pump Motor Cable	Red	2	
CN25	ADF Motor Cable	Black	4	---
CN31	STG FFC	--	8	
CN33	Panel FFC	--	28	19
CN36	I/F B FFC (FAX)	--	18	---
CN41	Scanner Carriage FFC	--	15	
CN49	Scanner CR Encoder FFC	--	6	
CN51	ADF Sensor Cable	White	4	---
CN501	Power Supply Unit Cable	White	5	

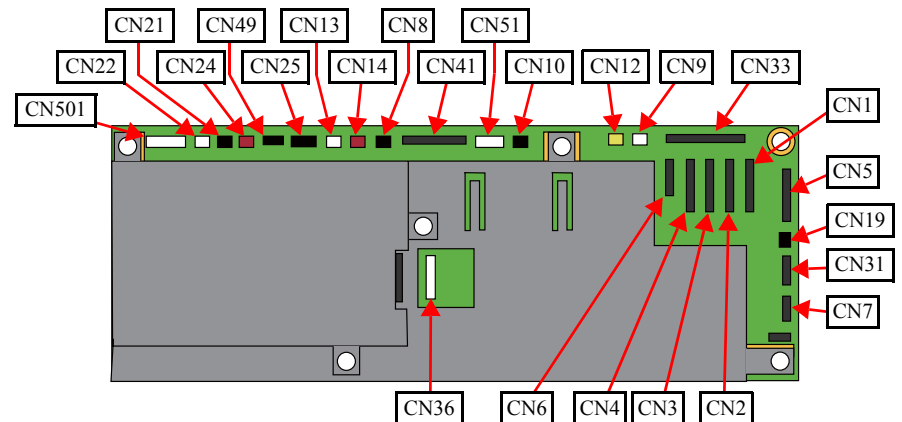


Figure 4-39. Connector position on the Main Board

2. Remove the screw (x1) that secures the Right Cable Frame and the Main Board. (See Fig. 4-40.)
3. Remove the screw (x1) that secures the Ferrite Core Holder A, and remove the Ferrite Core Holder A. (See Fig. 4-40.)
4. Remove the screw (x1) that secures the Grounding Plate M/B, and remove the Grounding Plate M/B. (See Fig. 4-40.)
5. Remove the screws (x3) that secure the Main Board Unit and remove the Main Board Unit.

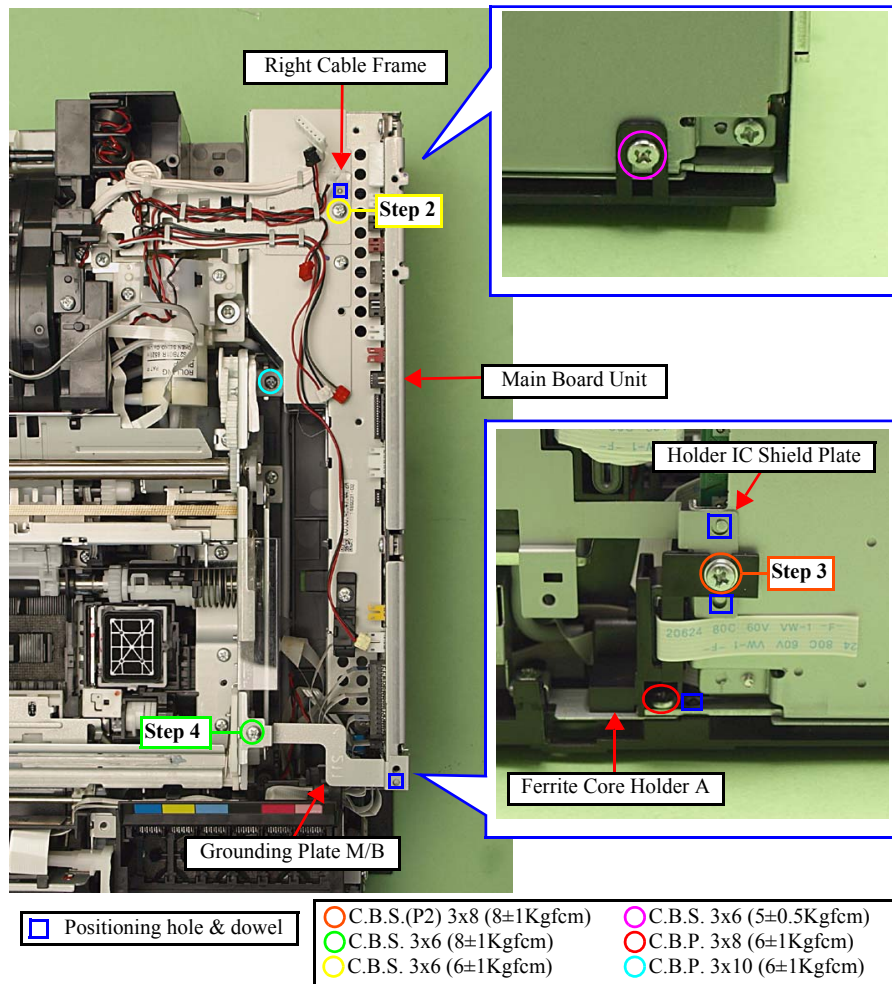


Figure 4-40. Removing the Main Board Unit

■ Main Board

1. Disconnect the I/F-B FFC from the FAX board. (Artisan 800/PX800FW/TX800FW only) (See Fig. 4-41.)
2. Remove the screws (x7) that secure the Upper Shield Plate M/B, and remove the Upper Shield Plate M/B.

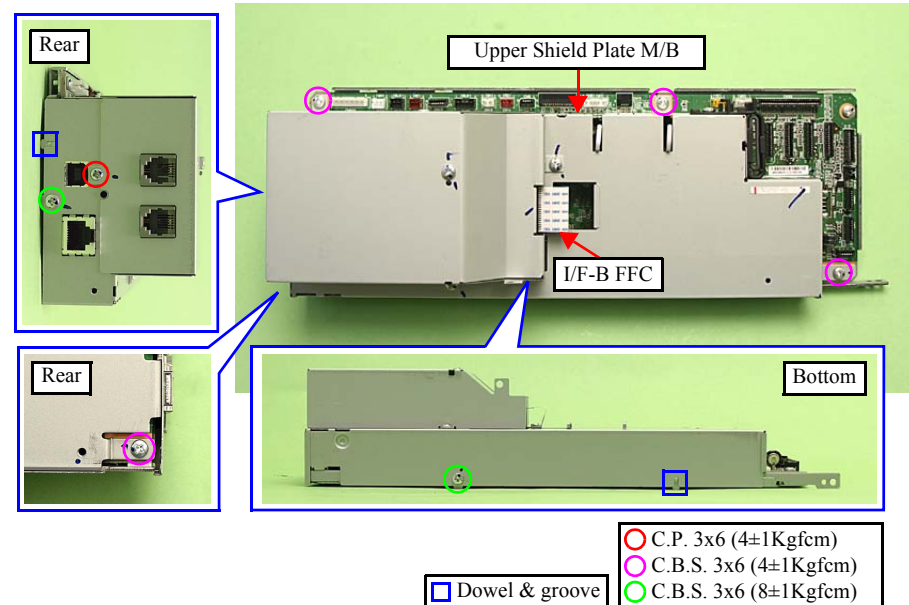


Figure 4-41. Removing the Main Board (1)

3. Remove the screws (x3) that secure the Main Board and remove the Main Board from the Lower Shield Plate M/B.

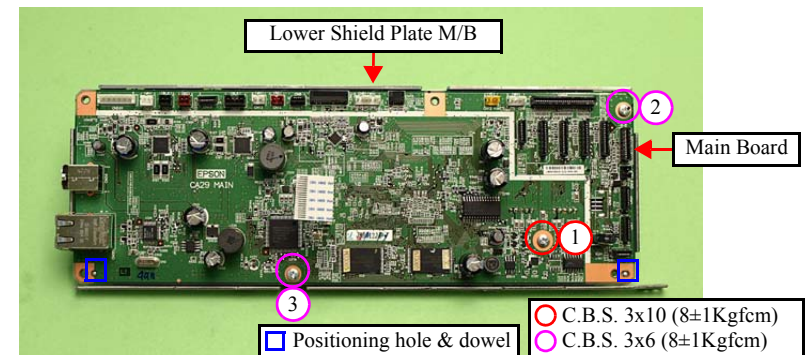


Figure 4-42. Removing the Main Board (2)

■ FAX Board (IF-B Board) (Artisan 800/PX800FW/TX800FW only)

1. Disconnect the I/F-B FFC from the FAX Board. (See Fig. 4-43.)
2. Remove the screws (x4) that secure the Shield Plate FAX, and remove the Shield Plate FAX from the Upper Shield Plate M/B.

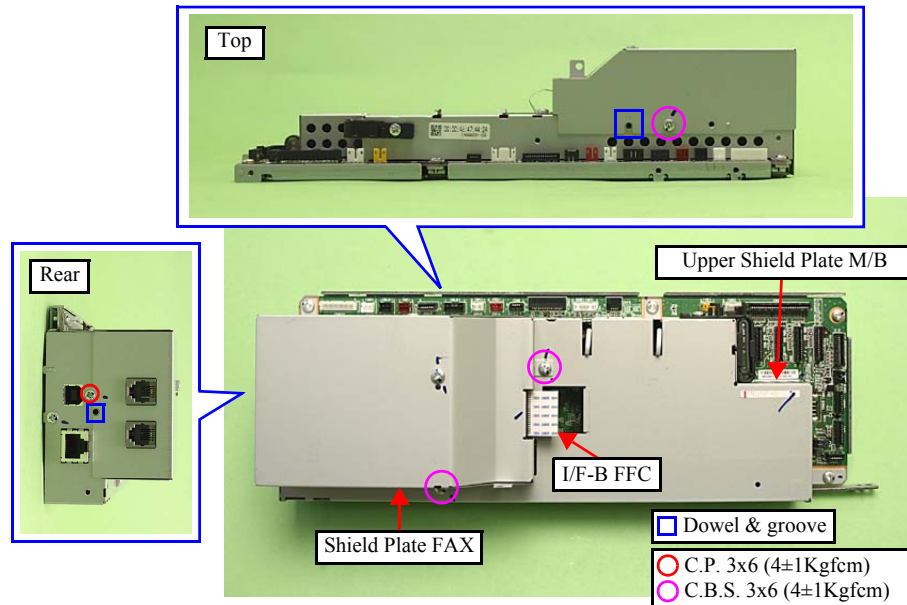


Figure 4-43. Removing the FAX Board (1)

3. Remove the screws (x4) that secure the FAX Board and remove the FAX Board from the Upper Shield Plate M/B.

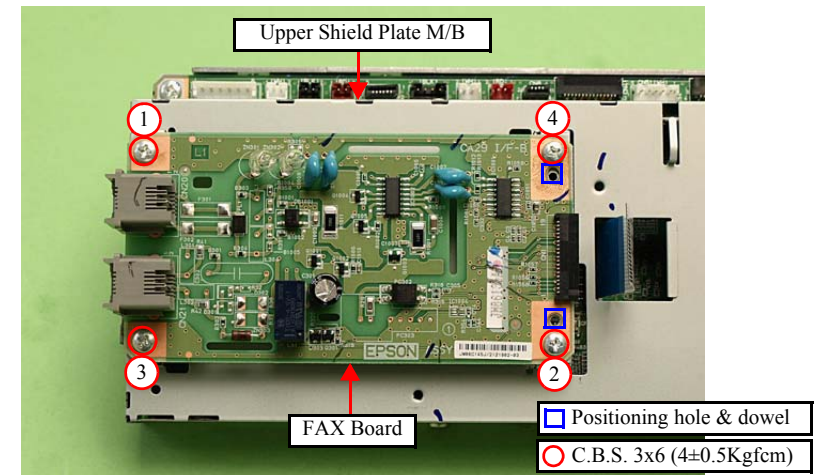


Figure 4-44. Removing the FAX Board (2)



- Align the positioning holes (x2) of the Main Board with the dowels (x2) of the Upper Shield Plate M/B. (See Fig. 4-42.)
- When installing the Main Board, tighten the screws in the order shown in Fig. 4-42.
- Align the dowels (x2) of the Lower Shield Plate M/B with the grooves (x2) of the Upper Shield Plate M/B. (See Fig. 4-41.)
- Align the positioning holes (x2) of the FAX Board with the dowels of the Upper Shield Plate M/B. (See Fig. 4-44.)
- When installing the FAX Board, tighten the screws in the order shown in Fig. 4-44.
- Align the grooves (x2) of the Shield Plate FAX with the dowels (x2) of the Upper Shield Plate M/B. (See Fig. 4-43.)
- Align the positioning hole (x1) of the Main Board with the dowel (x1) of the Upper Shield Plate M/B. (See Fig. 4-40.)

REASSEMBLY



- When connecting the I/F-B FFC to the Main Board, connect it as shown in Fig. 4-45.

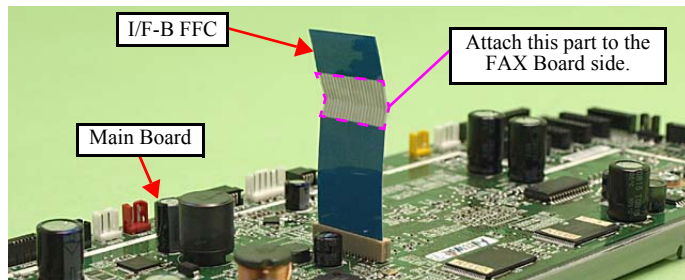


Figure 4-45. Connecting the I/F-B FFC

- Attach the Ferrite Core Holder A as follows.
 1. Align the dowels (x2) of the Main Board Unit with the positioning holes (x2) of the Holder IC Shield Plate.
 2. Secure the Ferrite Core Holder A and the Holder IC Shield Plate to the Main Board Unit with the screw. (See Fig. 4-40.)
- Align the dowel (x1) of the Main Board Unit with the positioning hole (x1) of the Right Cable Frame. (See Fig. 4-40.)
- Insert the rib (x1) of the Grounding Plate M/B to the hole of the Main Board Unit, and align the positioning hole (x1) of the Grounding Plate M/B with the dowel (x1) of the Main Board Unit, and attach the Grounding Plate M/B. (See Fig. 4-40, Fig. 4-46.)

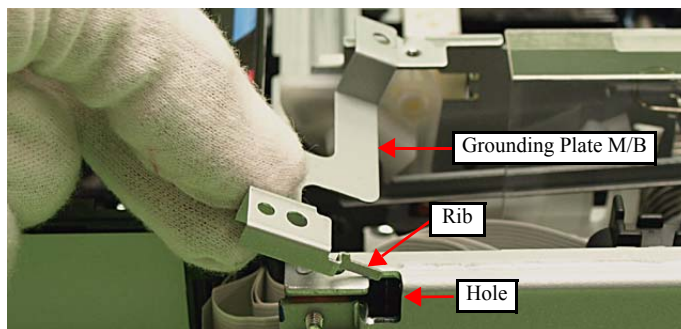


Figure 4-46. Attaching the Grounding Plate M/B

REASSEMBLY



- When attaching the CR Encoder FFC, follow the procedure below.
 1. Put the CR Encoder FFC through the ferrite core.
 2. Connect the CR Encoder FFC to the connector (CN6) on the Main Board.
 3. Insert the rib of the Ferrite Core Holder B to the hole of the Main Board, and secure it with the screw (x1).

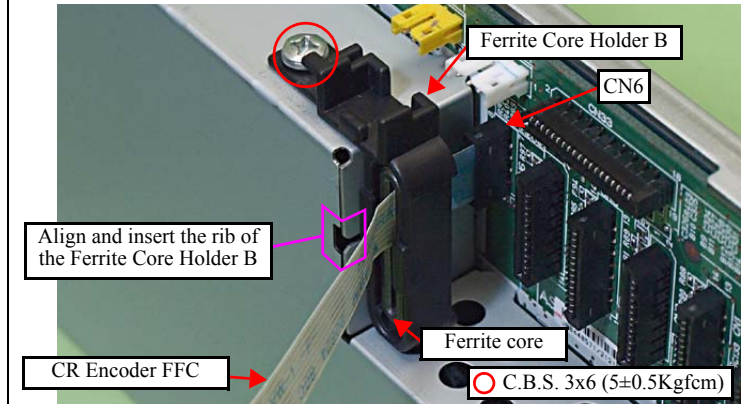


Figure 4-47. Attaching the CR Encoder FFC

- For routing cables and FFCs, see 4.4 "Routing FFC/cables" (p202).

ADJUSTMENT
REQUIRED

- When replacing the Main Board, the MAC address need to be set if the EEPROM data could not be read from the old Main Board. In this case, attach the new "Label, MAC address (Parts number: 1489231)" to the position shown in Fig. 4-48 and execute "5.2.6 "MAC Address Setting" (p223)".



Figure 4-48. Position for the MAC Address Label

- After removing/replacing the Main Board, make the specified adjustments. (See Chapter 5 "ADJUSTMENT".)

4.2.3.3 Power Supply Unit

- Parts/Components need to be removed in advance:

ADF Unit (Artisan 800/PX800FW/TX800FW only)/Scanner Unit/Upper Left Housing/Paper Guide Top Assy/Upper Housing/Rear Left Housing/Left Housing

- Removal procedure

1. Peel off the PF Encoder FFC from the Power Supply Unit. (See Fig. 4-49.)
2. Disconnect the Power Supply Unit cable from the connector of the Power Supply Unit. (See Fig. 4-49.)
3. Remove the screws (x2) that secure the Power Supply Unit, and remove the Power Supply Unit from the Base Frame.

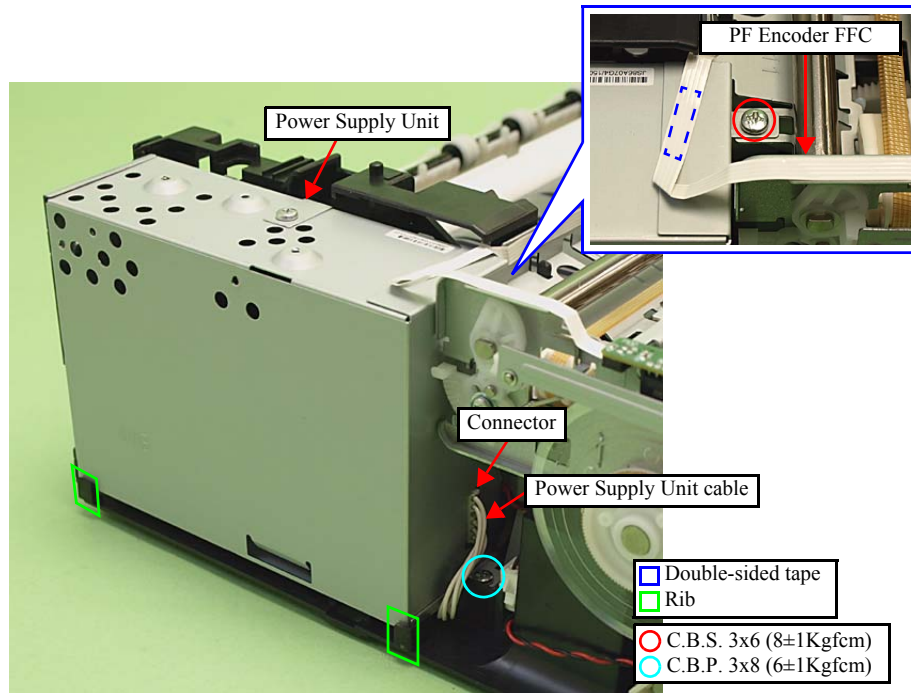


Figure 4-49. Removing the Power Supply Unit



- Route the Power Supply Unit Cable through the groove of the Base Frame, then install the Power Supply Unit to the Base Frame.

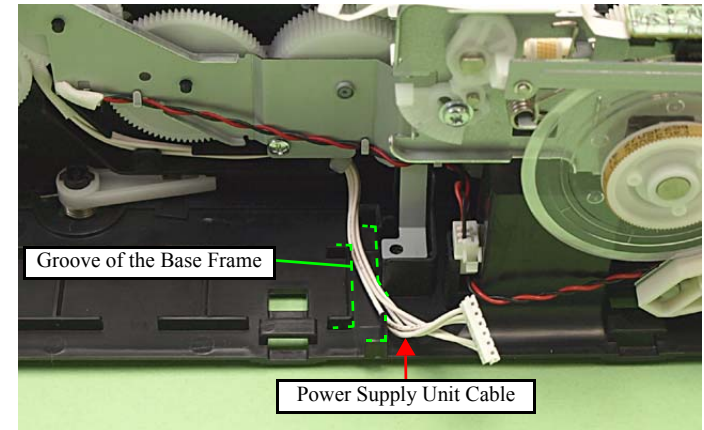


Figure 4-50. Installing the Power Supply Unit

- Install the Power Supply Unit inside the ribs (x2) of the Base Frame. (See Fig. 4-49)
- Be careful not to damage the Power Supply Unit cable by catching it with the screw when screwing. (See Fig. 4-49)
- Secure the PF Encoder FFC to the Power Supply Unit with the double-sided tape. (See Fig. 4-49)



After removing/replacing the Power Supply Unit, make the specified adjustments. (See Chapter 5 "ADJUSTMENT".)

4.2.3.4 Wireless LAN Board

- Parts/Components need to be removed in advance:

ADF Unit (Artisan 800/PX800FW/TX800FW only)/Scanner Unit/Upper Left Housing/Paper Guide Top Assy/Upper Housing/Hinge/Rear Right FAX Housing/Right Housing

- Removal procedure

1. Remove the screws (x2) that secure the Wireless LAN Board, and remove the Wireless LAN Board from the hooks (x2) of the Base Frame.

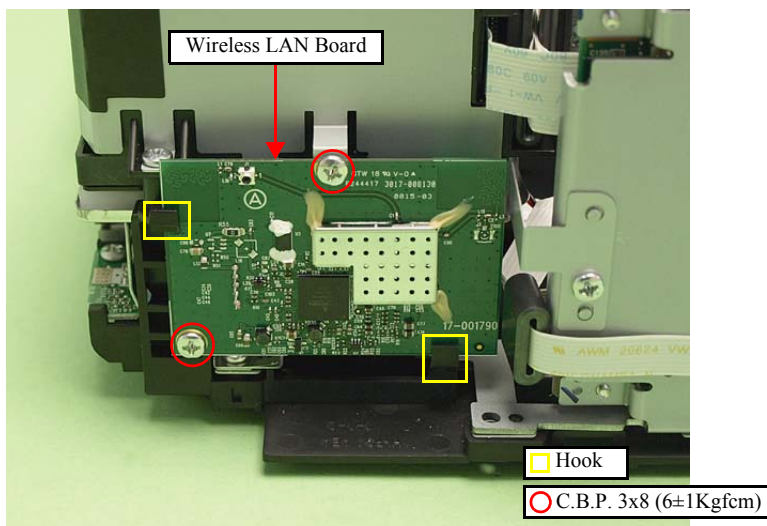


Figure 4-51. Removing the Wireless LAN Board (1)

2. Disconnect the Wireless LAN cable from the connector and remove the Wireless LAN Board.

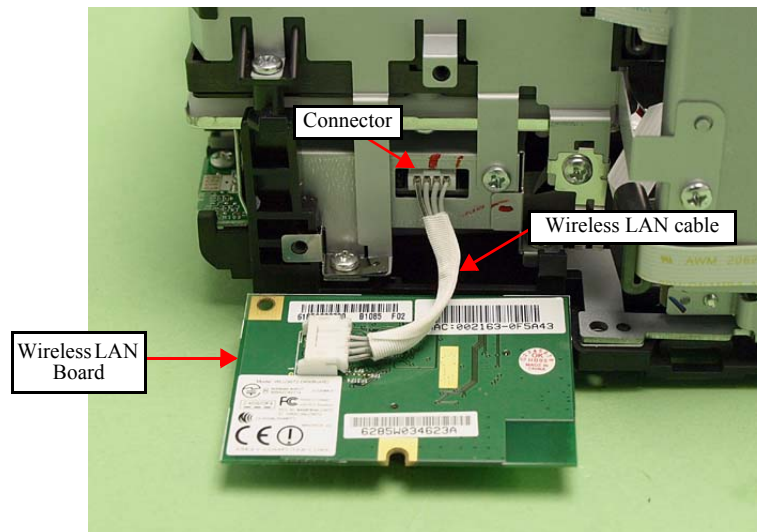


Figure 4-52. Removing the Wireless LAN Board (2)



When installing the Wireless LAN Board, align it with the hooks (x2) of the Base Frame. (See Fig. 4-51)

4.2.3.5 Card Slot Assy

CHECK POINT



- The disassembly/reassembly procedures of Epson Artisan 700/Epson Stylus Photo PX700W/TX700W differ from those of Epson Artisan 800/Epson Stylus Photo PX800FW/TX800FW. See 4.3.2.3 "Card Slot Assy (Artisan 700/PX700W/TX700W)" (p199) for the procedures.
- The Card Slot Assy includes the SUB Board and the STG Board.

WARNING



When powering this product, high-voltage current may be applied on the SUB Board. To prevent ELECTRIC SHOCK, do not touch the SUB Board section when the power is ON.
If the shock should happen, the flowing current is very tiny, about a few hundreds μ A, therefore it will not do any harm on the human body.

- Parts/Components need to be removed in advance:

ADF Unit (Artisan 800/PX800FW/TX800FW only)/Scanner Unit/Upper Left Housing/Paper Guide Top Assy/Upper Housing/Hinge/Rear Right FAX Housing/Right Housing/Main Board Unit/Wireless LAN Board/CSIC Assy/Cartridge Box Unit/Ink Supply Tube Assy

- Removal procedure

1. Remove the screws (x2) that secure the Card Slot Assy and remove the Grounding Plate.

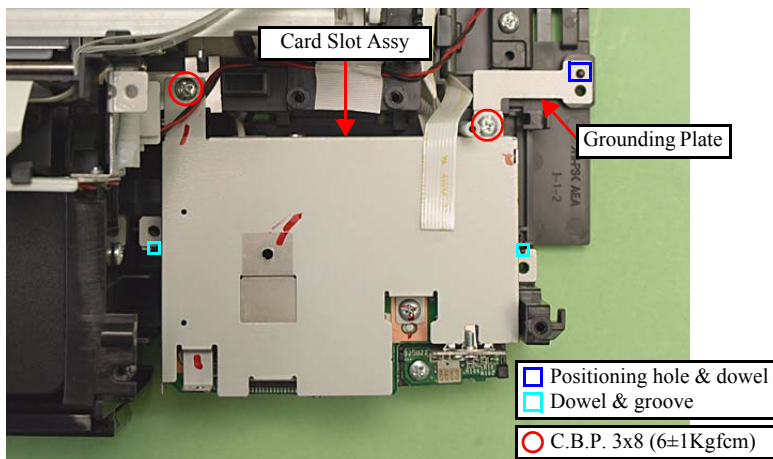


Figure 4-53. Removing the Card Slot Assy (1)

2. Disconnect the AID cable from the connector on the SUB Board, and remove the Card Slot Assy.

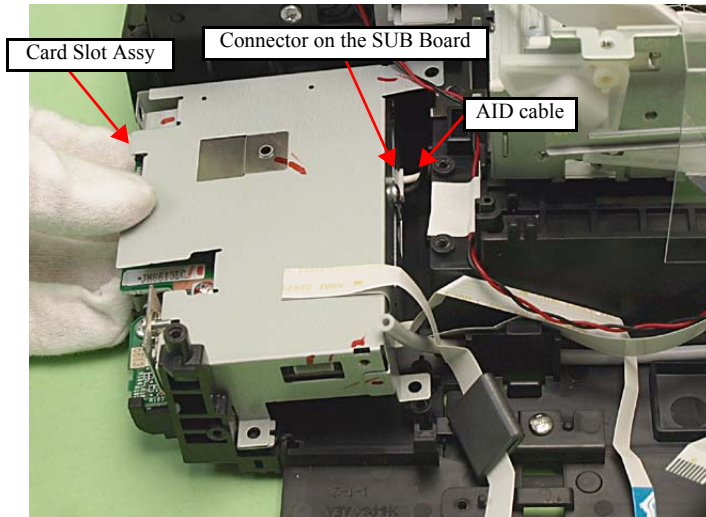


Figure 4-54. Removing the Card Slot Assy (2)

REASSEMBLY



- Connect the AID cable properly to the connector on the SUB Board. (See Fig. 4-54.)
- Align the grooves (x2) of the Card Slot Assy with the dowels (x2) of the Base Frame. (See Fig. 4-53.)
- When attaching the Grounding Plate, install it over the Card Slot Assy, and align the positioning hole of the Grounding Plate with the dowel of the Base Frame, and tighten them together with the screw. (See Fig. 4-53.)
- For routing the FFCs, see 4.4 "Routing FFC/cables" (p202).

ADJUSTMENT REQUIRED



After removing/replacing the Card Slot Assy, make the specified adjustments. (See Chapter 5 "ADJUSTMENT".)

4.2.4 Disassembling the Printer Mechanism

4.2.4.1 Printhead

CAUTION

■ About I/C Decompress

This printer is equipped with the ink supply mechanism that pressurizes ink constantly even though the printer is turned off. Therefore, if the joint of the ink supply tubes connected with the printhead is removed without discharging the ink in the ink tube, the ink leaked from the junction point of the Ink Supply Tube Assy and the Printhead might contaminate the surroundings.

If the ink gets into the Decompression tube of the Ink Supply Tube Assy, it may adversely affect the ink supply to the Printhead. To prevent this from happening, make sure to execute "5.4.1 I/S Decompress (p244)" and discharge ink in the ink supply path before disassembling, then remove the Printhead.

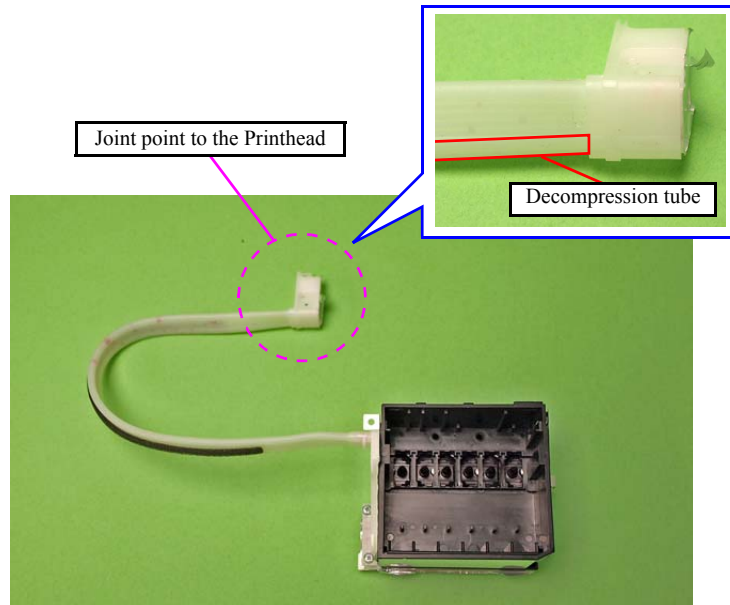


Figure 4-55. Ink Supply IC Holder Assy

CAUTION

■ The procedure (including checks/adjustments); required before/after removing or replacing the Printhead, varies according to the target part to replace. Make sure to follow the figure below when operating.

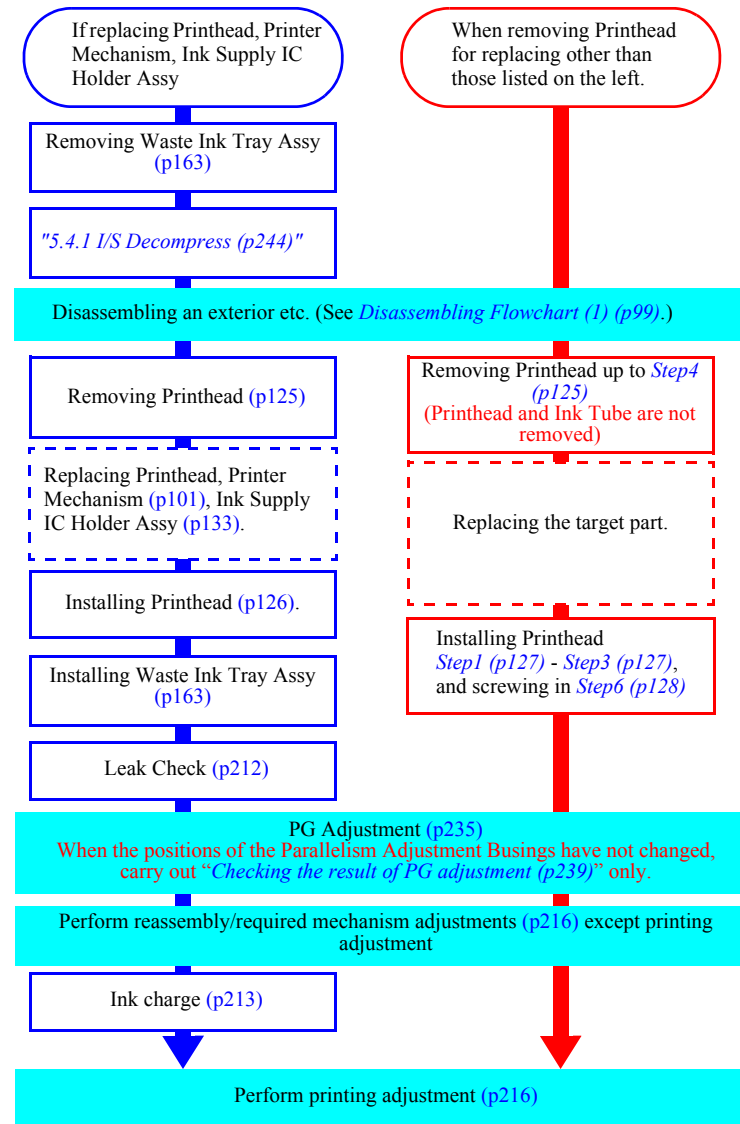


Figure 4-56. Related work for removing/installing the Printhead

- Parts/Components need to be removed in advance:

ADF Unit (Artisan 800/PX800FW/TX800FW only)/Scanner Unit/Upper Left Housing/Paper Guide Top Assy/Upper Housing

- Removal procedure

1. Place the Carriage stopper jig on 80-digit side on the Paper Guide Front Assy.
2. Turn the Spur Gear in the direction of the arrow, and release the Carriage Lock. (See Fig. 4-57.)
3. Move the Carriage Unit to the 80-digit side, and place it on the Carriage stopper jig.

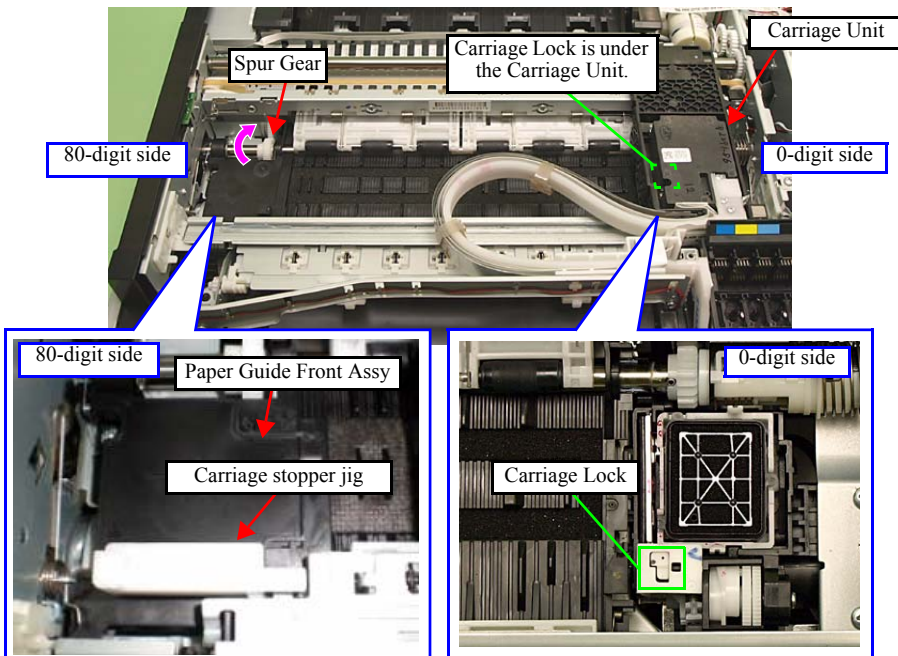


Figure 4-57. Releasing the Carriage lock and placing the Carriage stopper jig



- When handling the Printhead, make sure not to touch or damage the nozzle plate surface of the head. (See Fig. 4-59.)
- Do not damage or contaminate the CR Seal, or touch it with bare hands either. (See Fig. 4-62.)

4. Remove the screws (x4) that secure the Printhead and the Ink Supply Tube Assy, and detach the Printhead from the Carriage Unit.

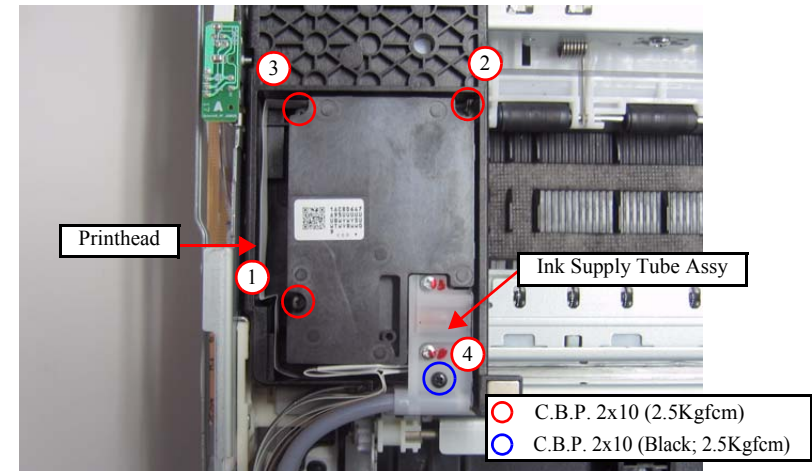


Figure 4-58. Removing the Printhead (1)

5. Disconnect the Head FFC (x2) from the Printhead.

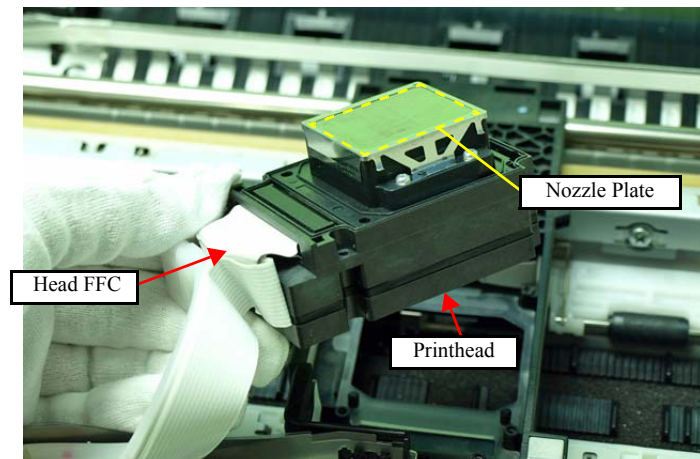


Figure 4-59. Removing the Printhead (2)

CAUTION

- In the next steps, make sure to take measures against contamination of the surroundings from ink such as receiving it with BEMCOT or the like.
- Using a piece of clean BEMCOT or the like, wipe off the leaked ink when removing the Printhead.
- Make sure not to touch the joint point of the Printhead and the Ink Supply Tube Assy. (See Fig. 4-60.)

6. Remove the screws (x2) that secure the Ink Supply Tube Assy and remove the Ink Supply Tube Assy from the Printhead, then remove the Printhead.

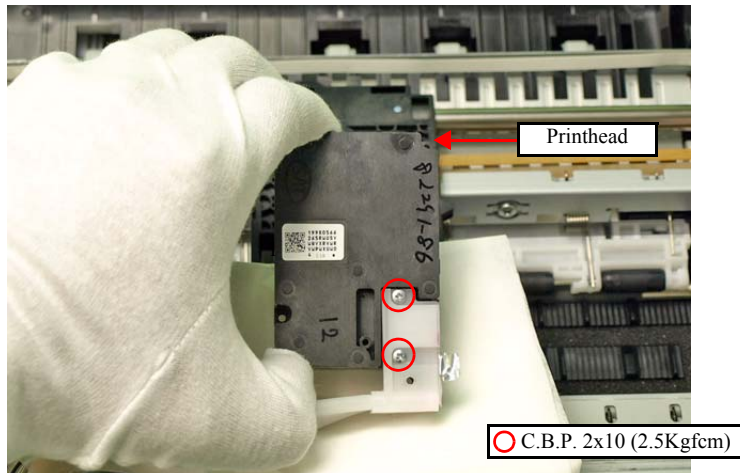


Figure 4-60. Removing the Printhead (3)

ASSEMBLING THE PRINthead**CAUTION**

- When assembling the Printhead, make sure to use the Ink Supply Tube screwing tool following the procedure in this section in order to avoid spilling ink from the joint of the Ink Supply Tube Assy and the Printhead.

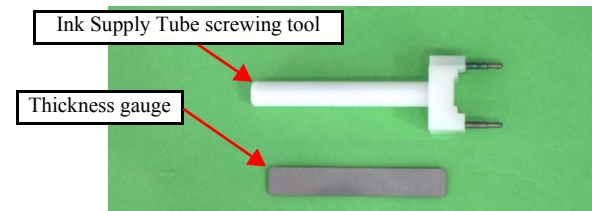


Figure 4-61. Ink Supply Tube screwing tool

CHECK POINT

- When installing the Printhead, confirm the CR Seal is not folded or out of position, then install it without any gap in between.
- When the CR Seal gets out of position, make sure to align the positioning holes (x2) of it with the dowels (x2) on the Carriage Unit, then install it without any gap.

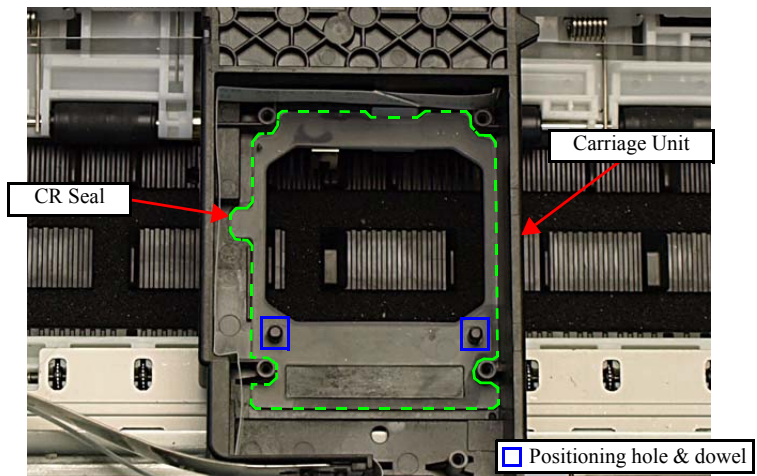


Figure 4-62. Installing the CR Seal

- When installing the Printhead, make sure to move the Carriage to the 80-digit side and place it on the Carriage stopper jig in order to prevent the frame from deforming.

1. Make sure of the installing condition and correct it if there is any gap. (See Fig. 4-62.)
2. Install the Head FFC to the Printhead. (See 4.2.4.1 *Printhead Step5 (p125)*.)
3. Install the Printhead to the Carriage Unit, and secure it as follows:

CAUTION

- When tightening the screws that secure the Printhead; to avoid burring the slot, first align the screw to the hole, and turn it to the left slightly to engage the threaded parts of the screw and the hole correctly, then tighten it.
- Make sure to follow the specified tightening torque.
- When securing the Printhead, make sure to observe strictly the following. Otherwise, the Printhead may be secured at an angle, which may adversely affect the print quality.

- 3-1. Place the hand on the center of the Printhead, and align the screws (x3) with the screw holes to temporary tighten the screws 1 and 2 alternately by 90 degrees slowly while pressing the Printhead in the direction of the arrow shown in Fig. 4-63.
- 3-2. Tighten the screw 3 to the same level as the screws 1 and 2 before completely tighten them.
- 3-3. Tighten the screws slowly by 90 degrees in the order shown in Fig. 4-63 to secure the Printhead.

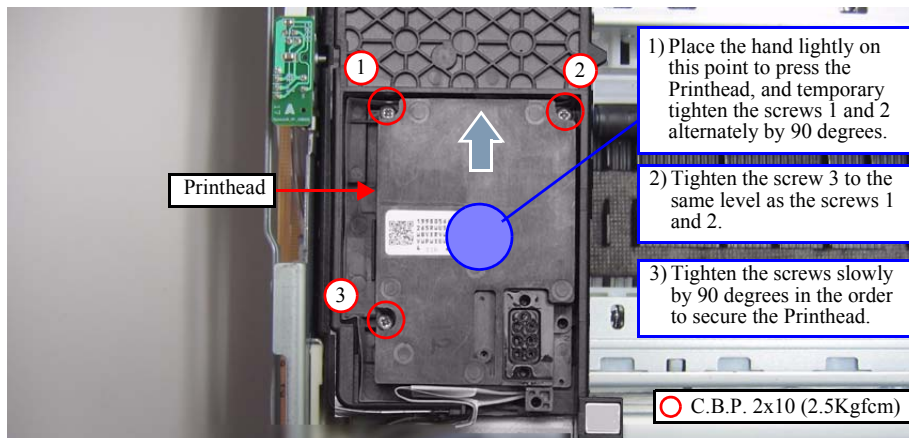


Figure 4-63. Assembling the Printhead (1)

CHECK POINT

Make sure to install the Ink Supply Tube Assy after confirming that the SEAL JOINT,H;B is surely attached on the joint point of the Ink Supply Tube Assy to the Printhead.

The SEAL JOINT,H;B is not included in the new Ink Supply Holder IC Assy, therefore, take out the SEAL JOINT,H;B from the old one in advance, and attach it to the new one without any gap confirming the correct direction to avoid installing it to the wrong holes.

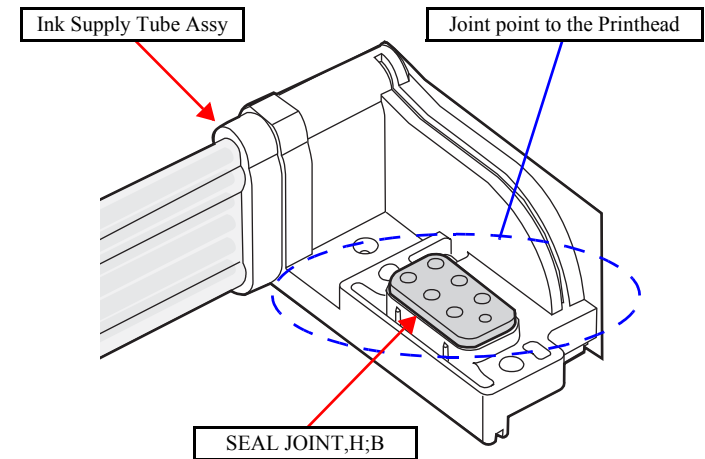


Figure 4-64. SEAL JOINT,H;B

4. Insert the tip of the Ink Supply Tube screwing tool to the screw hole of the Ink Supply Tube Assy.

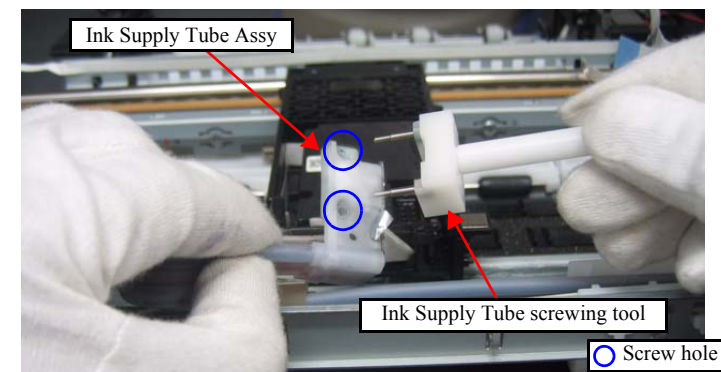


Figure 4-65. Assembling the Printhead (2)

5. Into the screw hole of the Printhead, align and slowly insert the tip of the Ink Supply Tube screwing tool inserted in the Ink Supply Tube Assy.

**CHECK
POINT**



If the joint of the Printhead and the Ink Supply Tube Assy is not disconnected, simply tighten the screw shown in Fig. 4-66 without using the jig.

6. Secure the Ink Supply Tube Assy with the screw with the Ink Supply Tube screwing tool inserted.

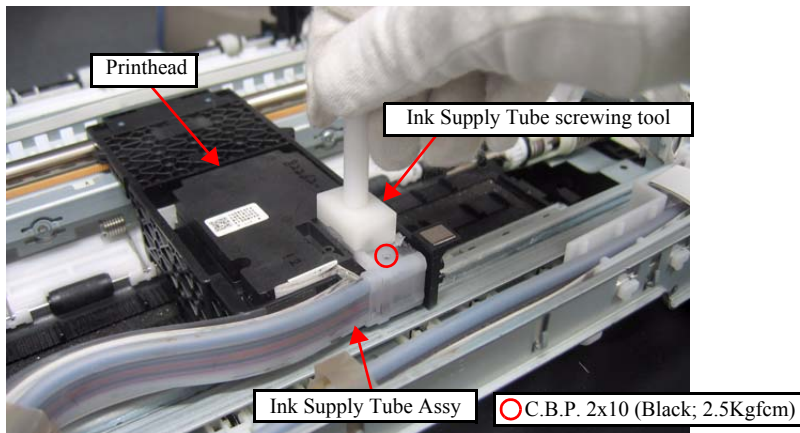


Figure 4-66. Assembling the Printhead (3)

7. Insert the thickness gauge from the hole on the side of the Ink Supply Tube screwing tool, and remove the tool gently while holding the Ink Supply Tube Assy.

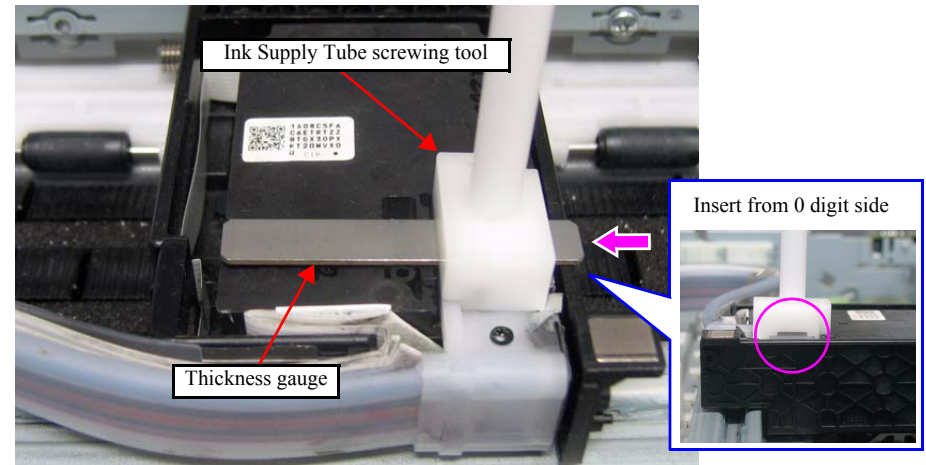


Figure 4-67. Assembling the Printhead (4)

8. Tighten the screws (x2) in order shown in Fig. 4-68 while holding the thickness gauge, and secure the Ink Supply Tube Assy to the Printhead.



Figure 4-68. Assembling the Printhead (5)

CHECK
POINT

Confirm that there is no ink penetrating into the Decompression Tube located inside the Ink Supply Tube Assy. If such ink penetration is observed, make sure to replace the Ink Supply IC Holder Assy (p133) together with the Printhead.

ADJUSTMENT
REQUIRED

- After removing/replacing the Printhead, make the specified adjustments. (See Chapter 5 "ADJUSTMENT".)
- When disconnecting the joint of the Printhead and the Ink Tube, in particular, the Leak Check is necessary.
- If the position of the notch on the Parallelism Adjustment Busings have not changed, only "Checking the result of PG adjustment (p239)" is necessary. (See "PG Adjustment (p235)".)

4.2.4.2 CR Scale

- Parts/Components need to be removed in advance:
ADF Unit (Artisan 800/PX800FW/TX800FW only)/Scanner Unit/Upper Left Housing/Paper Guide Top Assy/Upper Housing
- Removal procedure

CAUTION



- Do not touch the CR Scale with bare hands.
- Do not damage or contaminate the CR Scale.
- Take care not to damage (extend too much) the Torsion Spring 16.43.

1. Release the Carriage Lock and move the Carriage Unit to the center. (See 4.2.4.1 Printhead Step2 (p125).)
2. Release the right side of the CR Scale from the hook.
3. Pull out the CR Scale from the slit of the CR Encoder Sensor.

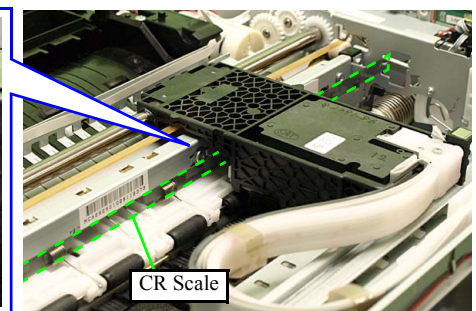
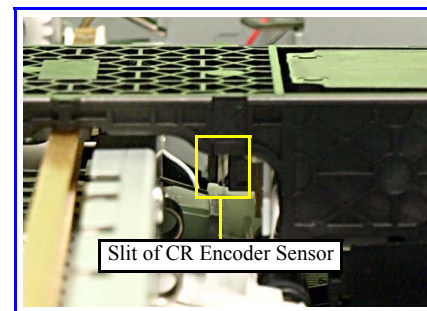
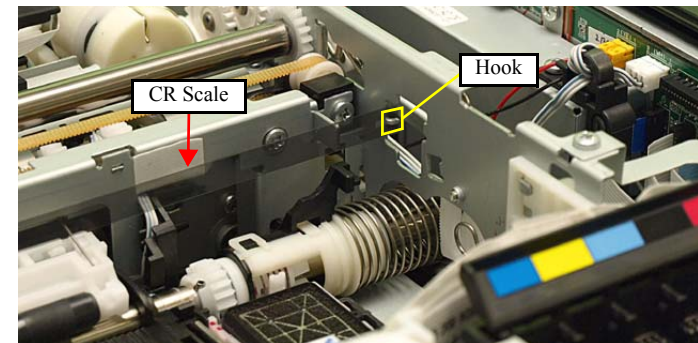


Figure 4-69. Removing the CR Scale(1)

4. Detach the Torsion Spring 16.43 from the hook of the Main Frame.
5. Rotate the CR Scale 90 degrees as shown below, and remove it from the Main Frame.

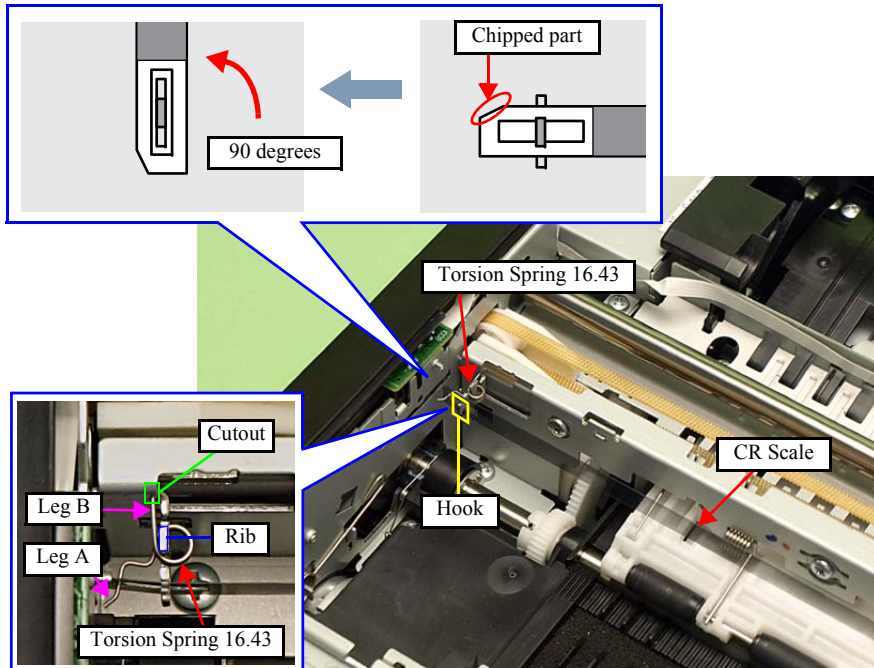


Figure 4-70. Removing the CR Scale(2)



- Attach the CR Scale to the hook on the left of the printer with the chipped part upward. (See Fig. 4-70.)
- Make sure to put the CR Scale through the slit of the CR Encoder Sensor. (See Fig. 4-69.)
- When installing the Torsion Spring 16.43, follow the procedure below. (See Fig. 4-70.)
 1. Attach the leg A to the hole of the CR Scale.
 2. Attach the Torsion Spring 16.43 to the rib on the Main Frame.
 3. Attach the leg B to the cutout of the Main Frame.

4.2.4.3 Decompression Pump Unit

- Parts/Components need to be removed in advance:
 - ADF Unit (Artisan 800/PX800FW/TX800FW only)/Scanner Unit/Upper Left Housing/Paper Guide Top Assy/Upper Housing/Hinge/Rear Right FAX Housing/Right Housing/Main Board
- Removal procedure
 1. Remove the decompression tube from the socket of the Cartridge Box Unit. (See Fig. 4-71.)
 2. Release the decompression tube from the groove on the Base Frame.

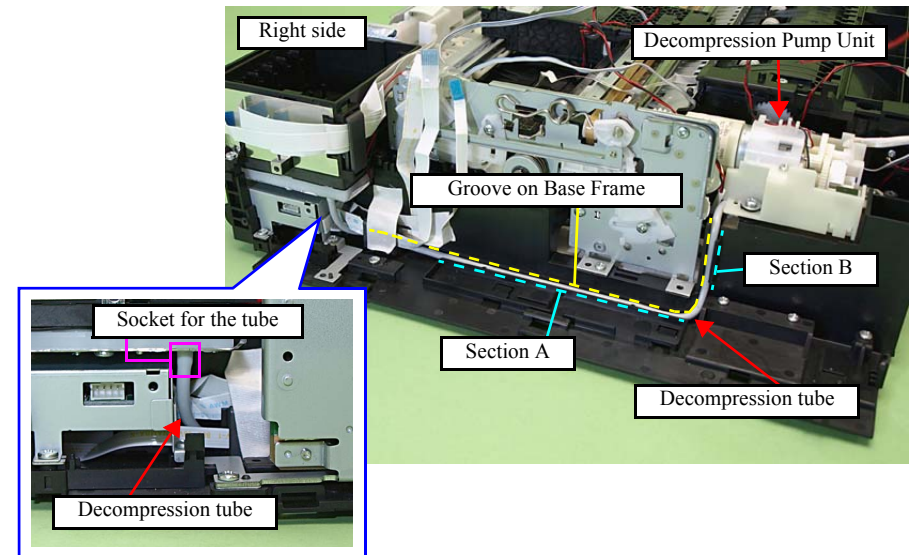


Figure 4-71. Removing the Decompression Pump Unit

- Remove the screws (x3) that secure the Decompression Pump Unit, and remove the Decompression Pump Unit from the Base Frame.

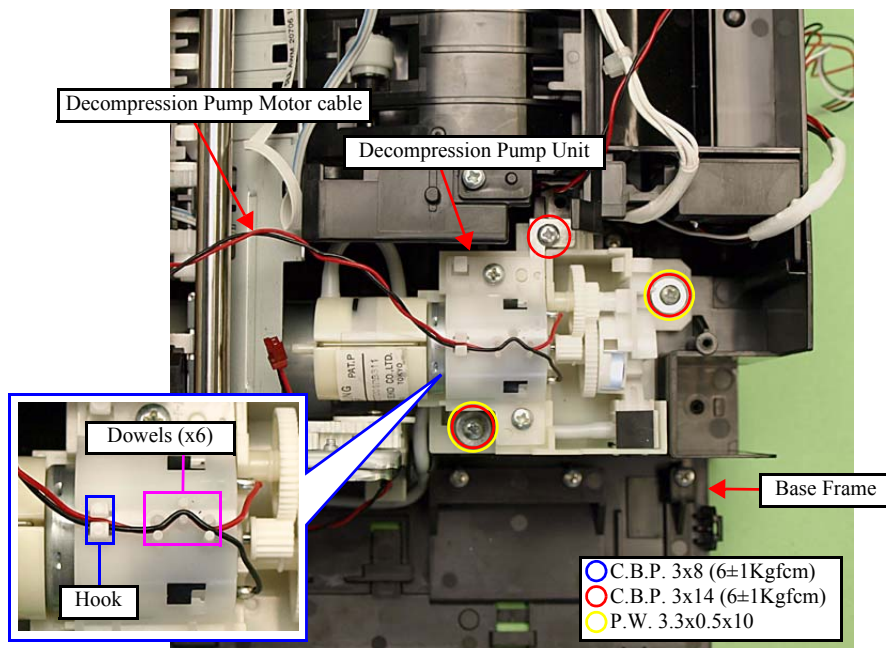


Figure 4-72. Removing the Decompression Pump Unit



- When routing the Decompression Pump Motor cable, make sure to secure it with the dowels (x6) and the hook on top of the Decompression Pump Unit as shown in Fig. 4-72.
- When routing the decompression tube, confirm no clipped part or fold on the tube. (See Fig. 4-71, Fig. 4-73.)

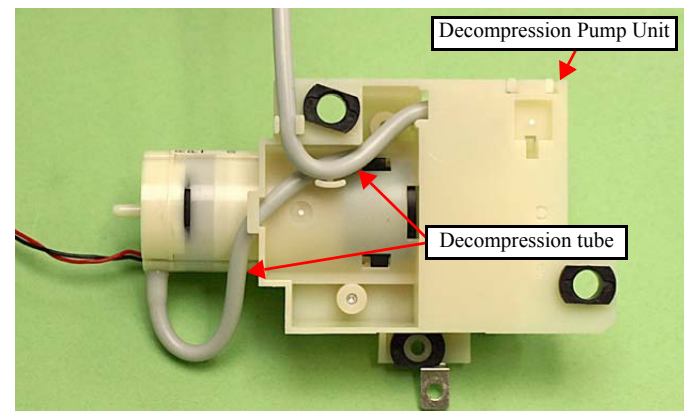


Figure 4-73. Installing the Decompression Pump Unit

- Put the decompression tube through the groove on the Base Frame (section A, B), and route it behind the FFC. (See Fig. 4-71.)
- Make sure to insert the decompression tube into the socket on the Cartridge Box Unit to the full to its base. (See Fig. 4-71.)

4.2.4.4 CSIC Assy

- Parts/Components need to be removed in advance:

ADF Unit (Artisan 800/PX800FW/TX800FW only)/Scanner Unit/Upper Left Housing/Paper Guide Top Assy/Upper Housing

CHECK POINT



In the case of Artisan 700/PX700W/TX700W, removing the Right Rear Housing (p192) and the Right Housing (p193) earlier will make the operation easier.

- Removal procedure

1. Disconnect the CSIC FFC from the CSIC connector.

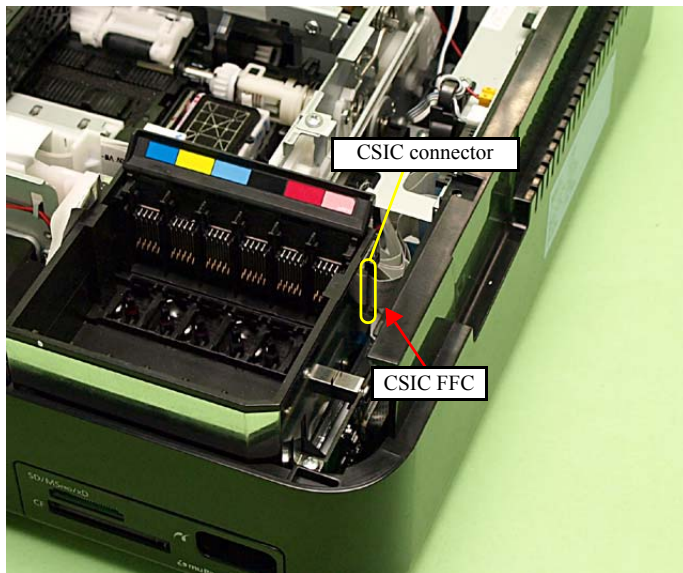


Figure 4-74. Removing the CSIC Assy (1)

2. Release the hooks (x2) on the rear of the Cartridge Box, and remove the CSIC Assy upward.

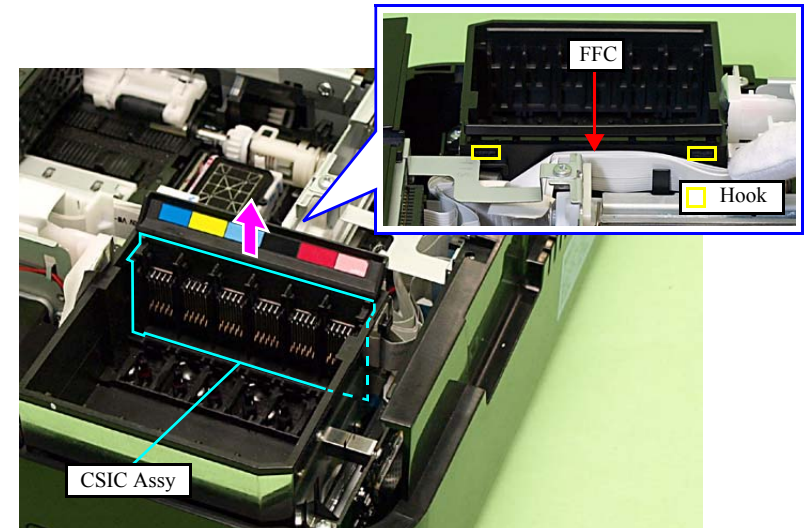


Figure 4-75. Removing the CSIC Assy (2)

4.2.4.5 Ink Supply IC Holder Assy

- Parts/Components need to be removed in advance:

ADF Unit (Artisan 800/PX800FW/TX800FW only)/Scanner Unit/Upper Left Housing/Paper Guide Top Assy/Upper Housing/Printhead/Hinge/Rear Right FAX Housing /Right Housing/Main Board/CSIC Assy/ Wireless LAN Board

- Removal procedure



■ The Ink Supply IC Holder Assy consists of the Ink Supply Tube Assy and the Cartridge Box Unit. (See Fig. 4-55.)
 ■ If the replacement of Ink Supply IC Holder Assy is not required, so as to minimize the related work, operate without disconnecting the joint of the Printhead. (See 4.2.4.1 "Printhead" (p124).)

1. Release the Head FFCs (x4) and the CR Encoder FFC from the ribs (x4) behind the Cartridge Box Unit.

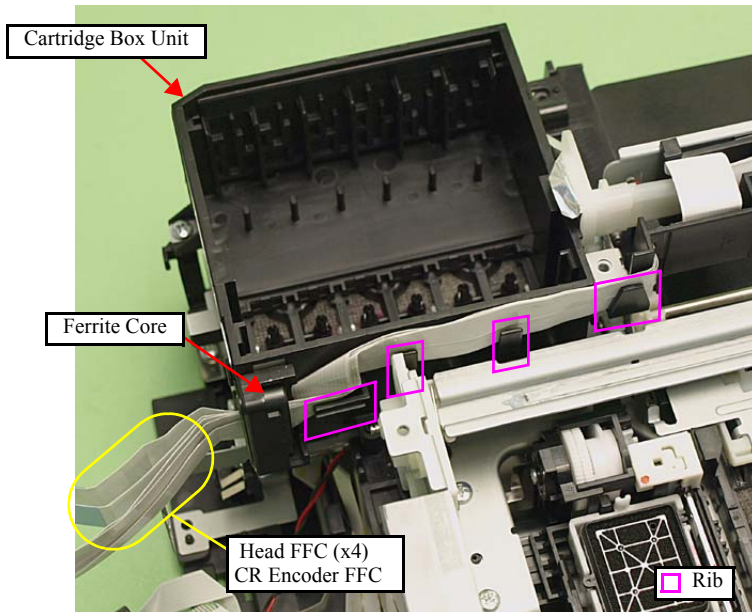


Figure 4-76. Releasing the FFCs

2. Release the hooks (x4) that secure the IC Guide, and remove the IC Guide from the Cartridge Box Unit.

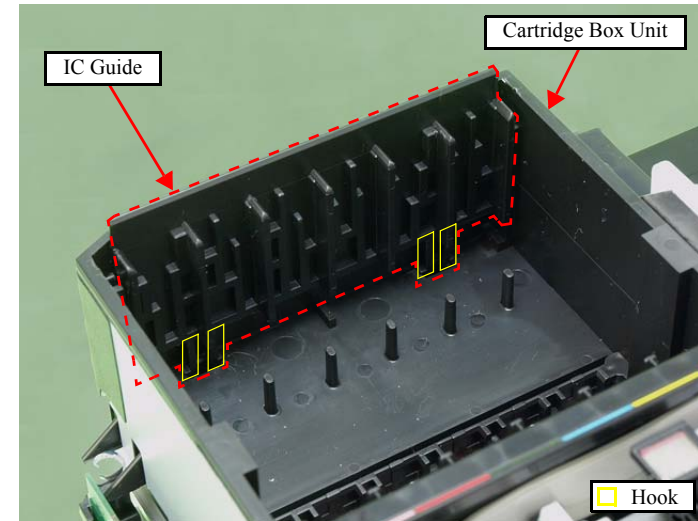


Figure 4-77. Removing the IC Guide

3. Disconnect the decompression tube from the socket on the Cartridge Box Unit. (See Fig. 4-71.)
4. Remove the screws (x7) that secure the Cartridge Box Unit.

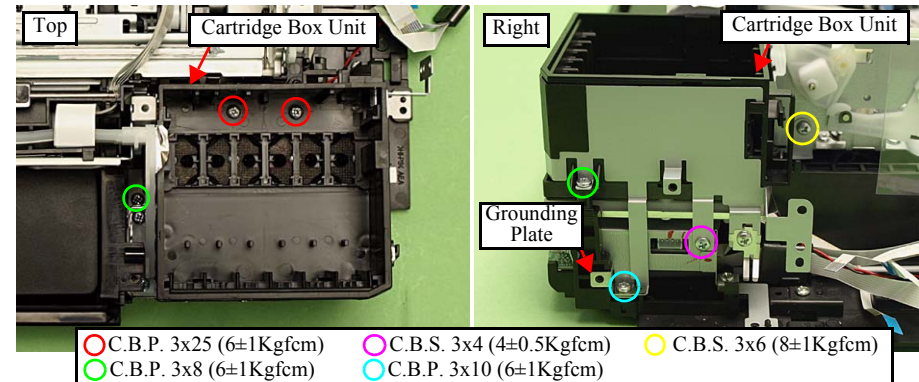


Figure 4-78. Removing the Cartridge Box Unit

WARNING

To prevent ink leakage, make sure not to separate the Ink Supply Tube Assy and the Cartridge Box Unit by removing the screws (x2) on the section A shown in Fig. 4-79. Loosening the screws on the section A even just once will cause ink leakage, therefore, make sure to replace the Ink Supply IC Holder Assy with a new one.

5. Release the Clamp Tubes (x2). (See Fig. 4-79.)
6. Release the Ink Supply Tube Assy and FFC from the FFC Holder, and remove the Ink Supply IC Holder Assy.

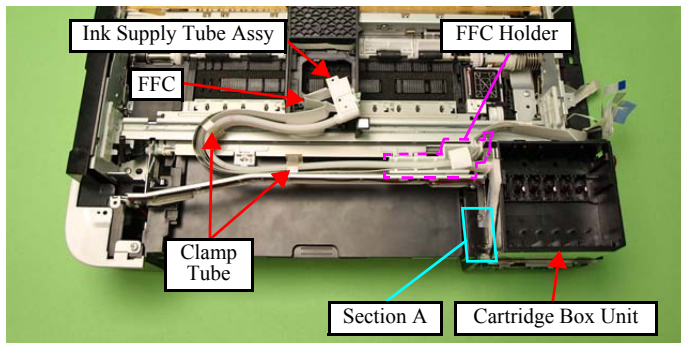


Figure 4-79. Removing the Ink Supply Tube Assy

REASSEMBLY

- Make sure to insert the decompression tube into the socket on the Cartridge Box Unit to the full to its base. (See Fig. 4-71.)
- Make sure to align the positioning hole (x1) on the Cartridge Box Unit with the dowel (x1) of the Base Frame when reassembling them. (See Fig. 4-80.)
- When installing the Cartridge Box Unit, make sure to secure the hooks (x2) on the Main Frame to their positioning holes (x2). (See Fig. 4-80.)

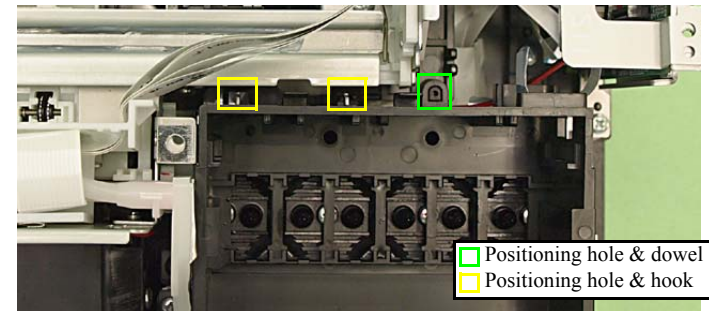


Figure 4-80. Installing the Cartridge Box Unit

- Make sure to attach the grounding plate to the place shown in Fig. 4-78, and secure it with the screw.

REASSEMBLY



- Secure the convex sections (x2) of the Clamp Tube into the hole of it from outside to inside as shown in [Fig. 4-81](#).
- Fold the wings inward as shown in [Fig. 4-81](#).

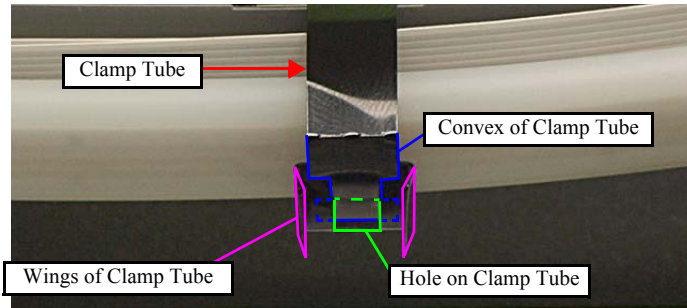


Figure 4-81. Installing the Clamp Tube

- When installing the Ink Supply IC Holder Assy, make sure to remove slack around the section B by moving the Carriage Unit between the 0-digit side and the 80-digit side a few times.

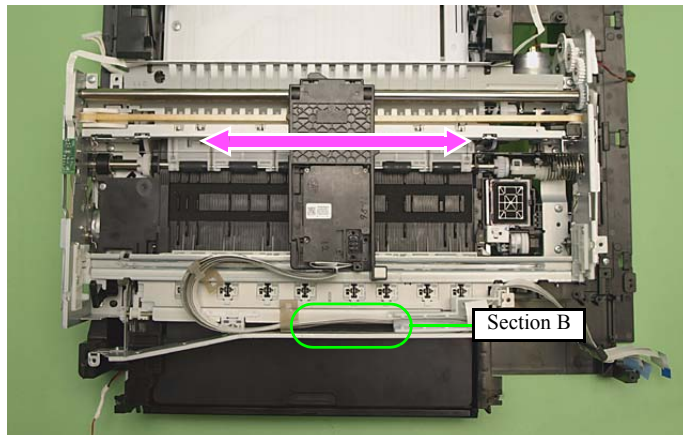


Figure 4-82. Installing the Ink Supply IC Holder Assy

- For routing the FFCs, see [4.4 "Routing FFC/cables" \(p202\)](#).

ADJUSTMENT
REQUIRED

After removing/replacing the Ink Supply IC Holder Assy, make the specified adjustments. (See [Chapter 5 "ADJUSTMENT"](#).)

4.2.4.6 Ink System



When powering this product, high-voltage current may be applied on the SUB Board. To prevent ELECTRIC SHOCK, do not touch the SUB Board section when the power is ON.

If the shock should happen, the flowing current is very tiny, about a few hundreds μA , therefore it will not do any harm on the human body.

- Parts/Components need to be removed in advance:
ADF Unit (Artisan 800/PX800FW/TX800FW only)/Scanner Unit/Upper Left Housing/Paper Guide Top Assy/Upper Housing
- Removal procedure
 1. Release the Carriage Lock and move the Carriage Unit to the center. (See [4.2.4.1 Printhead Step2 \(p125\)](#).)
 2. Remove the Waste Ink Tray Assy. (See [4.2.4.20 Waste Ink Tray Assy \(p163\)](#).)
 3. Remove the screw (x1) that secures the Ink System.

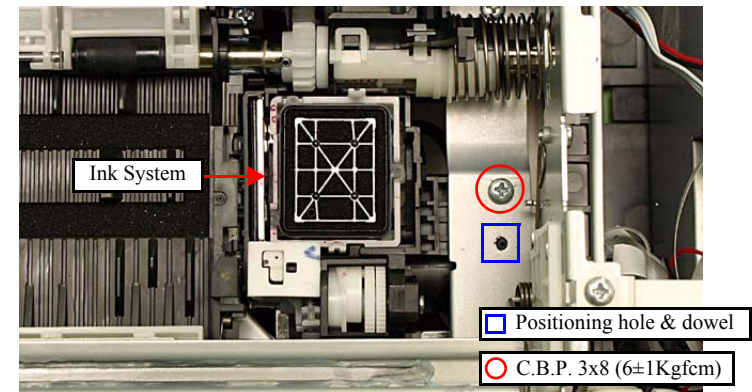


Figure 4-83. Removing the Ink System (1)

CAUTION

So as to make description easier, the printer in the photographs is placed vertically in the following steps. Be careful about ink spilling if the printer is tilted in practical operation.

4. Disconnect the AID cable from the connector on the SUB Board. (See Fig. 4-84.)

CAUTION

- Be careful about ink spilling from the Waste Ink Tube.
- Do not damage the Rubber Seal or the Head Cleaner on the cap with frames or other parts. (See Fig. 4-87.)

5. Remove the Ink System from the bottom of the printer.

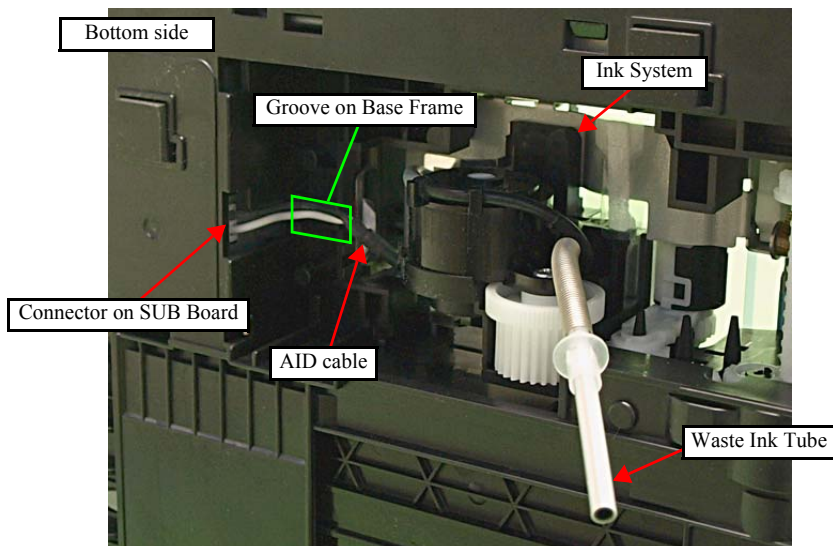


Figure 4-84. Removing the Ink System (2)

REASSEMBLY

Install the Ink System as follows:

1. When the Carriage Lock sticks out, rotate the Combination Gear in the direction of the arrow to lower the Carriage Lock.

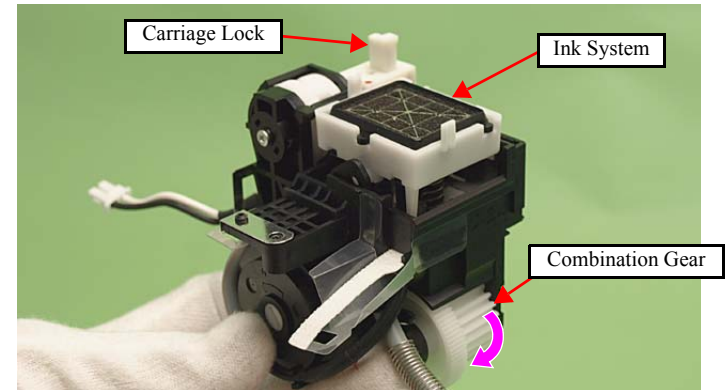


Figure 4-85. Installing the Ink System (1)

2. Press the switch lever in the direction of the arrow and move the Transmission Arm upward by rotating the Spur Gear to make a room.

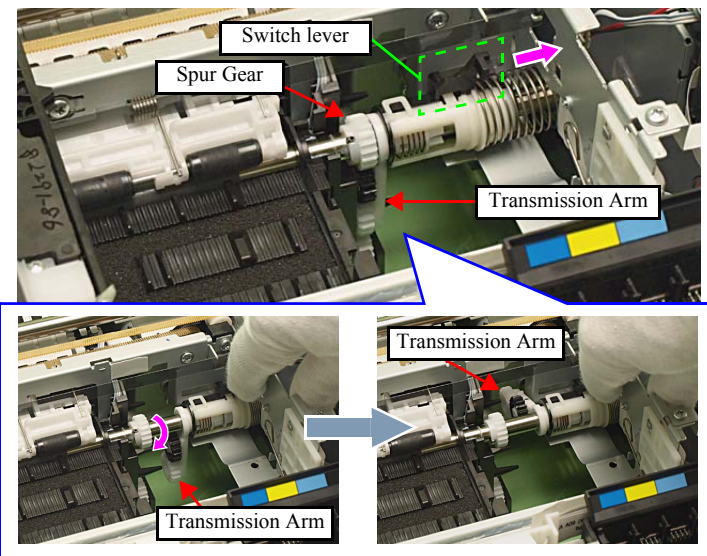


Figure 4-86. Installing the Ink System (2)

REASSEMBLY



3. Align the dowels (x2) and the positioning hole (x1) of the Ink System with the positioning holes (x2) on the Main Frame and the dowel (x1) on the Transmission Holder Assy shown in Fig. 4-87.

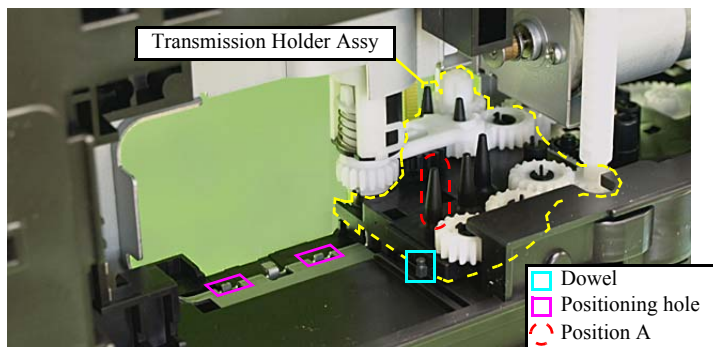
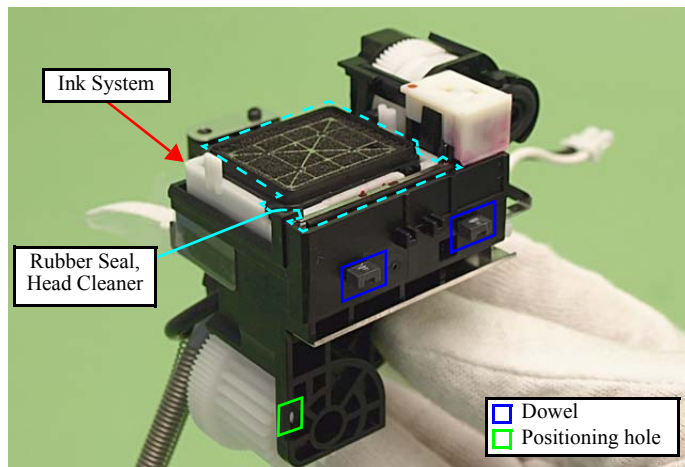


Figure 4-87. Installing the Ink System (3)

4. Align the dowel of the Ink System with the positioning hole on the Main Frame, and secure it with the screw (x1) to the Ink System.(See Fig. 4-83.)

(Continued to the next page.)

REASSEMBLY



5. Push the switch lever in the direction of the arrow and turn the spur gear (see Fig. 4-86.), then align the Transmission Arm to the position A (Ink System operation point) shown in Fig. 4-87.
6. Connect the AID cable to the connector on the SUB Board, and route the cable through the groove on the Base Frame. (See Fig. 4-84.)
7. Visually check the cap section to make sure that the Ink System is installed horizontally. If the cap surface is not horizontal, a fatal error may occur due to interfering with the carriages or print defect may occur because cleaning can not be performed due to capping defect.

ADJUSTMENT
REQUIRED

After removing/replacing the Ink System, make the specified adjustments. (See Chapter 5 "ADJUSTMENT".)

4.2.4.7 Lower ASF Paper Guide Assy

- Parts/Components need to be removed in advance:

ADF Unit (Artisan 800/PX800FW/TX800FW only)/Scanner Unit/Upper Left Housing/Paper Guide Top Assy/Upper Housing/Rear Left Housing/Left Housing/Decoration Belt/Power Supply Unit/Rear ASF Paper Guide Cover

- Removal procedure

1. Release the hooks (x2) and remove the Spur Gear A.

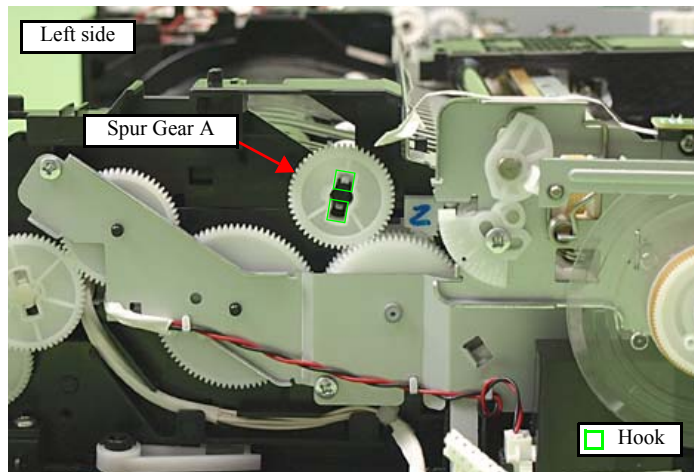


Figure 4-88. Removing the Lower ASF Paper Guide Assy (1)

2. Remove the screws (x3) that secure the Lower ASF Paper Guide Assy. (See Fig. 4-89.)
3. Remove the Lower ASF Paper Guide Assy while avoiding hitting the shaft of the Intermediate Roller A to the groove A on the Base Frame.

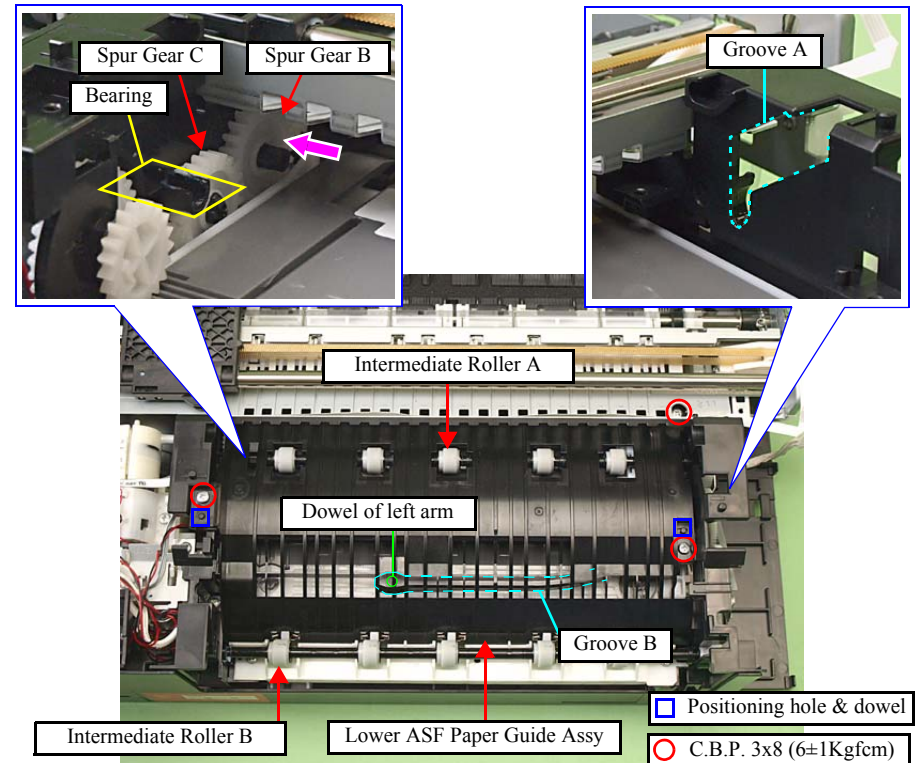


Figure 4-89. Removing the Lower ASF Paper Guide Assy (2)

4. Remove the screw (x1) that secures the Intermediate Roller fixing plate, and remove the Intermediate Roller fixing plate from the Lower ASF Paper Guide Assy.

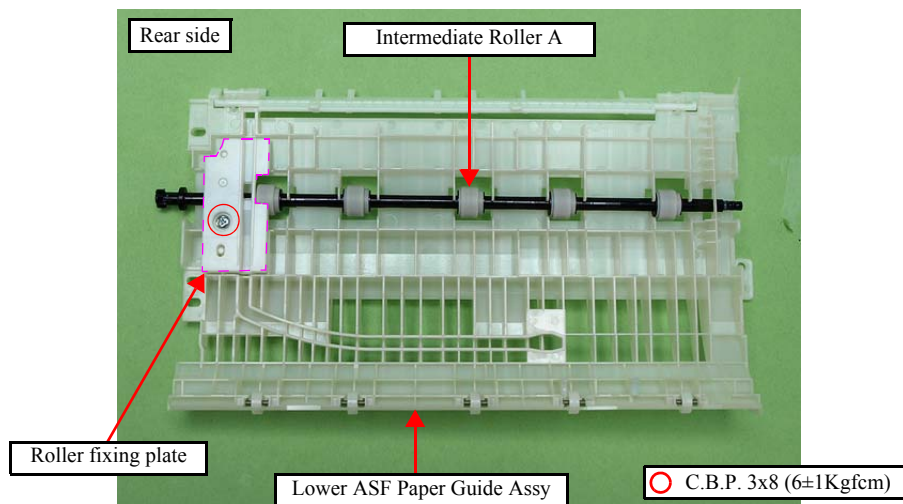


Figure 4-90. Removing the Lower ASF Paper Guide Assy (3)

5. Remove the Intermediate Roller A from the Lower ASF Paper Guide Assy.

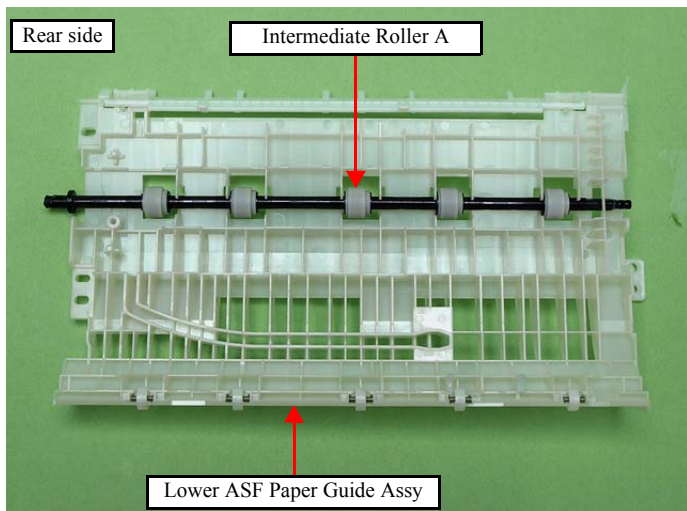


Figure 4-91. Removing the Lower ASF Paper Guide Assy (4)



- Paper feed defect will occur if the flap of the Lower ASF Paper Guide Assy comes off; therefore, take care in the following points to make sure that the flap is surely attached when installing the Lower ASF Paper Guide Assy.
 - Make sure that the shaft of the flap is surely installed.
 - The ribs (x2) of the flap are positioned on the rear of the Lower ASF Paper Guide Assy.

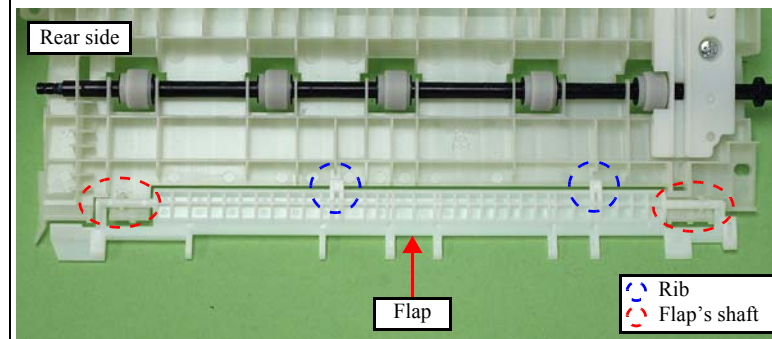


Figure 4-92. Installing the flap

REASSEMBLY



- Make sure to install the Lower ASF Paper Guide Assy while pressing the Spur Gear B in the direction of the arrow so as to engage it with the Spur Gear C. (See Fig. 4-89.)
- When installing the Lower ASF Paper Guide Assy, the tip of the flap is inserted between the CDR Tray Assy and the Upper Paper Guide. Take care not to damage the flap by getting contact with such parts then. (See Fig. 4-93.)
- Make sure to attach the Intermediate Roller A into the bearing on the Base Frame. (See Fig. 4-89.)
- Attach the rear side of the Lower ASF Paper Guide Assy so as to let its roller and the Intermediate Roller B touch. (See Fig. 4-89, Fig. 4-93.)

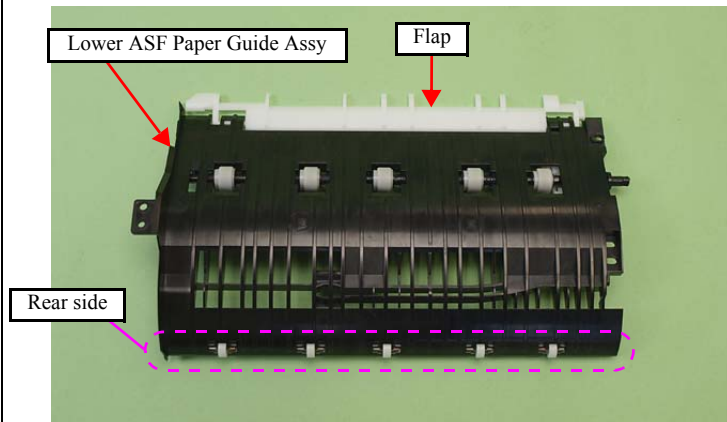


Figure 4-93. Installing the Lower ASF Paper Guide Assy

- Insert the dowel of the left arm of the CDR Tray Assy into the groove B on the Lower ASF Paper Guide Assy. (See Fig. 4-89.)
- Make sure to align the dowels (x2) of the Base Frame with the positioning holes (x2) of the Lower when reassembling them. (See Fig. 4-89.)

ADJUSTMENT
REQUIRED

When replacing the Lower ASF Paper Guide Assy, make sure to carry out the specified lubrication. (See Chapter 6 "MAINTENANCE".)

4.2.4.8 CDR Tray Assy

- Parts/Components need to be removed in advance:

ADF Unit (Artisan 800/PX800FW/TX800FW only)/Scanner Unit/Upper Left Housing/Paper Guide Top Assy/Upper Housing/Rear Left Housing/Left Housing/Decoration Belt/Power Supply Unit/Rear ASF Paper Guide Cover/Lower ASF Paper Guide Assy

- Removal procedure

1. Release the hook (x1) of the Spur Gear B on the Spur Gear A side, and remove the Spur Gear A. (See Fig. 4-94.)
2. Align the grooves on the CDR Tray Assy with the teeth of the Spur Gear B, and remove the Spur Gear B.

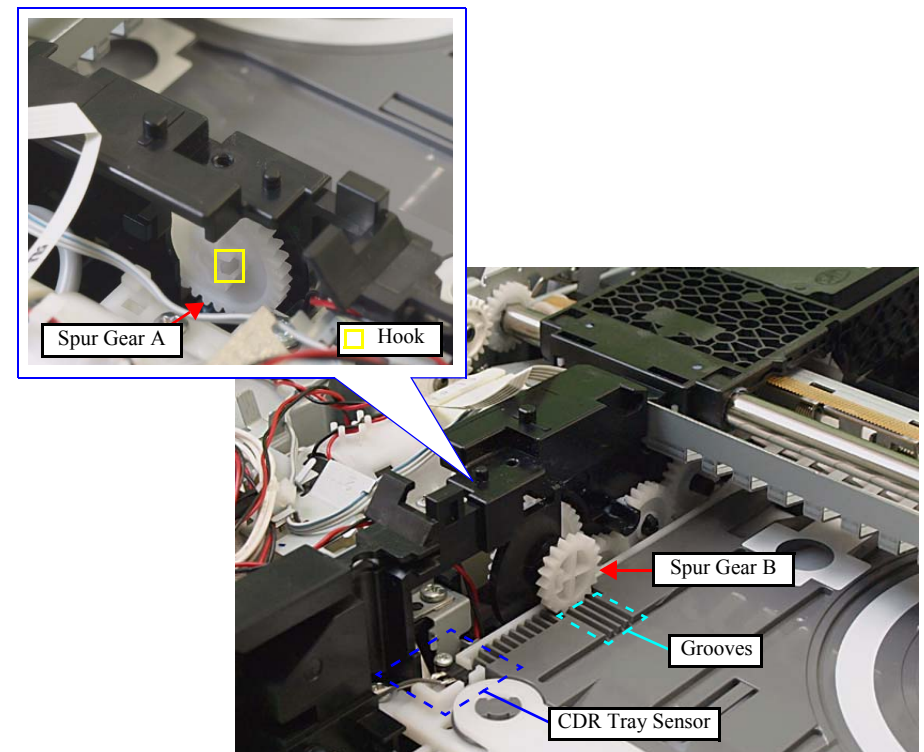


Figure 4-94. Removing the CDR Tray Assy (1)

CAUTION

Take care not to damage the CDR Tray Sensor when removing the CDR Tray Assy. (See Fig. 4-94, Fig. 4-95.)

- Lift the CDR Tray Assy on the side with arms, remove the CDR Tray Assy to the rear side of the printer.

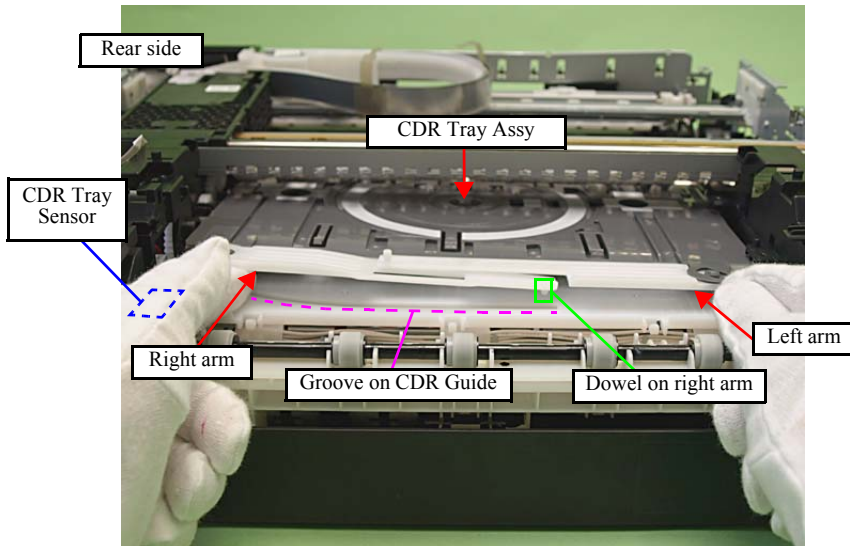


Figure 4-95. Remove the CDR Tray Assy (2)

REASSEMBLY

- Make sure to insert the dowel of the right arm into the groove on the CDR Guide. (See Fig. 4-95.)
- Place the left arm over the right arm before installation. (See Fig. 4-95.)
- If an arm comes off, place it to the CDR Tray at an angle as shown in Fig. 4-96, and insert the hole of the arm into the hook on the tray, then rotate it in the direction of the arrow to engage the arm to the tray.

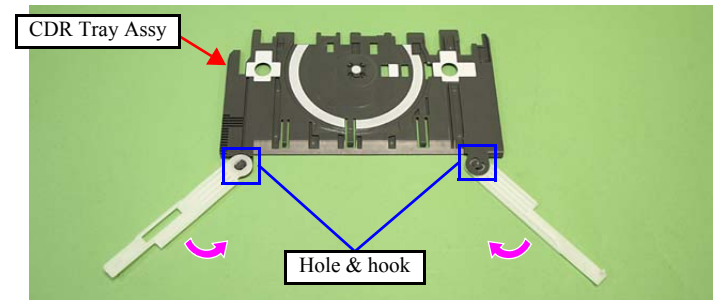


Figure 4-96. Reassembling the CDR Tray Assy

- When installing the Spur Gear B, engage its teeth with the grooves on the CDR Tray Assy. (See Fig. 4-94.)

**ADJUSTMENT
REQUIRED**

- After replacing the CDR Tray Assy, make the specified adjustments. (See Chapter 5 "ADJUSTMENT".)
- When replacing the CDR Tray Assy, make sure to carry out the specified lubrication. (See Chapter 6 "MAINTENANCE".)

4.2.4.9 LD Roller

- Parts/Components need to be removed in advance:

ADF Unit (Artisan 800/PX800FW/TX800FW only)/Scanner Unit/Upper Left Housing/Paper Guide Top Assy/Upper Housing/Rear Left Housing/Left Housing/Decoration Belt/Power Supply Unit/Rear ASF Paper Guide Cover/Lower ASF Paper Guide Assy

- Removal procedure

1. Release the hooks (x2) of the Combination Gear, and remove it from the shaft of the LD Roller.

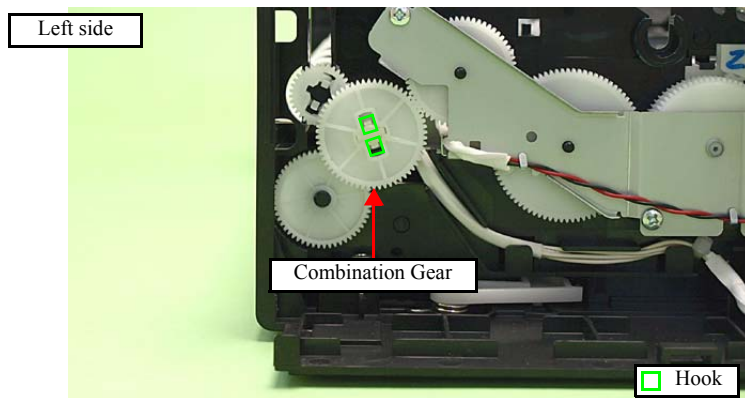


Figure 4-97. Removing the LD Roller (1)

2. Release the hooks (x2) on the Spur Gear, and remove it from the shaft of the Intermediate Roller.

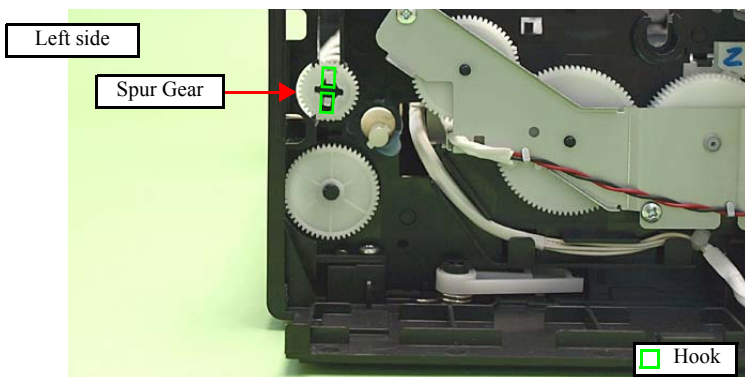


Figure 4-98. Removing the LD Roller (2)



Never touch or damage the surface of the Intermediate Roller as doing so can adversely affect print quality.

3. Lift the Intermediate Roller on the Power Supply Unit side, and remove the roller while pulling the other side of the shaft from the hole on the Base Frame.

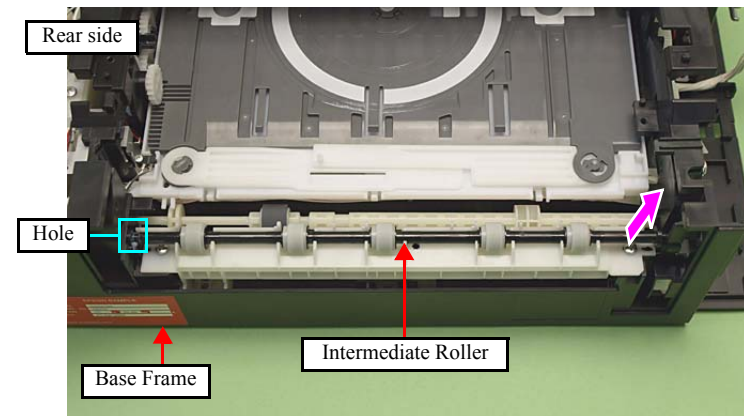


Figure 4-99. Removing the LD Roller (3)

4. Remove the screws (x2) that secure the Rear Paper Guide Assy, and remove the assy from the Base Frame.

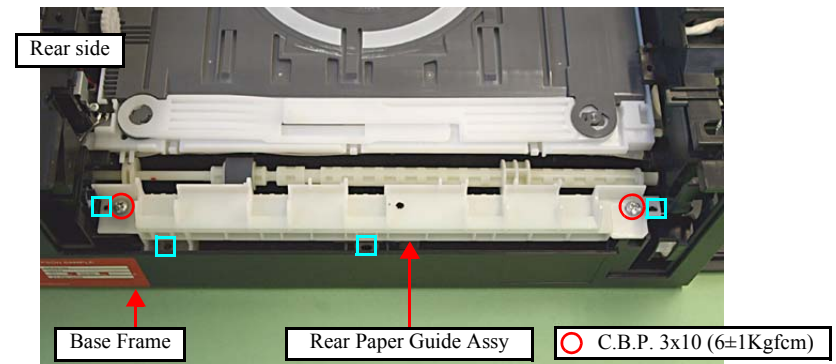


Figure 4-100. Removing the LD Roller (4)

CAUTION

Never touch or damage the surface of the LD Roller as doing so can adversely affect print quality.

- Slide the LD Roller in the direction of the arrow and pull out the Section A of the shaft from the Base Frame, then remove the LD Roller by pulling out the other side of the shaft from the Base Frame.

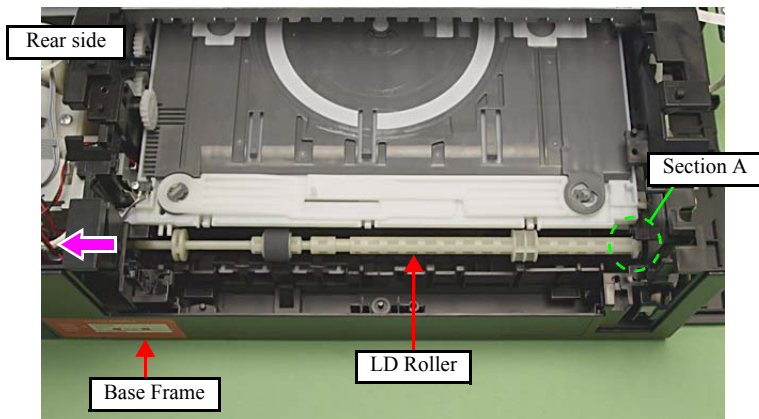


Figure 4-101. Removing the LD Roller (5)

REASSEMBLY

Make sure to align the dowels (x4) on the Base Frame with the positioning holes (x4) when reassembling the Rear Paper Guide Assy. (See Fig. 4-100.)

**ADJUSTMENT
REQUIRED**

When replacing the LD Roller, make sure to carry out the specified lubrication. (See Chapter 6 "MAINTENANCE".)

4.2.4.10 Pick-up Roller

- Parts/Components need to be removed in advance:
 - Cassette Unit
- Removal procedure

CAUTION

So as to make description easier, the printer in the photographs is placed vertically in the following steps. Be careful about ink spilling if the printer is tilted in practical operation.

- Release the hook (x1), and remove the Pick-up Roller Shaft Bush and Pick-up Roller Transmission Shaft.

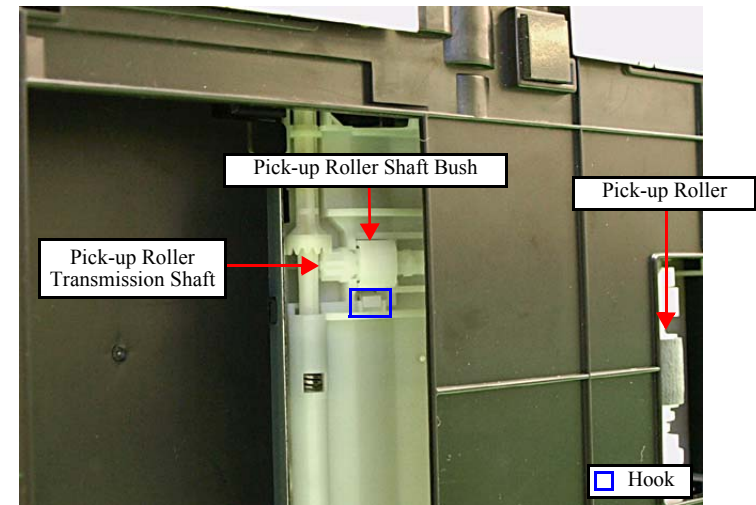


Figure 4-102. Removing the Pick-up Roller (1)

CAUTION

Be careful not to touch or damage the Pick-up Roller so can adversely affect print quality.

- Slide the Pick-up Roller in the direction of the arrow, and remove it.

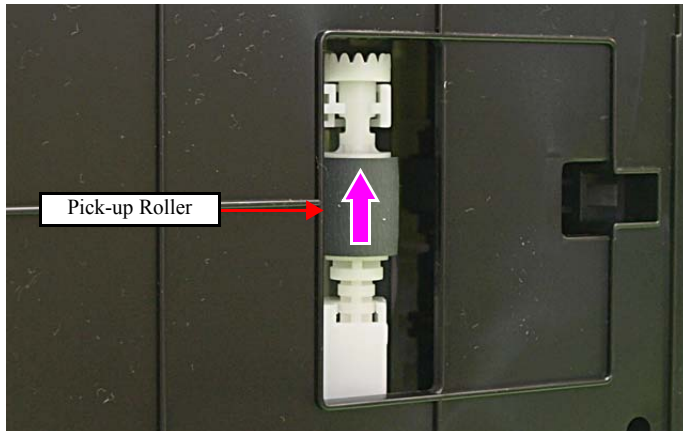


Figure 4-103. Removing the Pick-up Roller (2)

**ADJUSTMENT
REQUIRED**

When replacing the Pick-up Roller, make sure to carry out the specified lubrication. (See [Chapter 6 "MAINTENANCE"](#).)

4.2.4.11 Main Frame

- Parts/Components need to be removed in advance:

ADF Unit (Artisan 800/PX800FW/TX800FW only)/Scanner Unit/Upper Left Housing/Paper Guide Top Assy/Upper Housing/Rear Left Housing/Left Housing/Decoration Belt/Hinge/Rear Right Housing /Right Housing/Power Supply Unit/Rear ASF Paper Guide Cover/Lower ASF Paper Guide Assy/CDR Tray Assy/Main Board/CSIC Assy/Wireless LAN Board /Cartridge Box Unit/Ink Supply Tube Assy/Card Slot Assy/Decompression Pump Unit/Waste Ink Tray Assy

- Removal procedure

CAUTION

Since the Main Frame consists of several frames, it may deform when lifting it. When lifting the Main Frame, it is recommended to hold the positions shown in [Fig. 4-104](#).

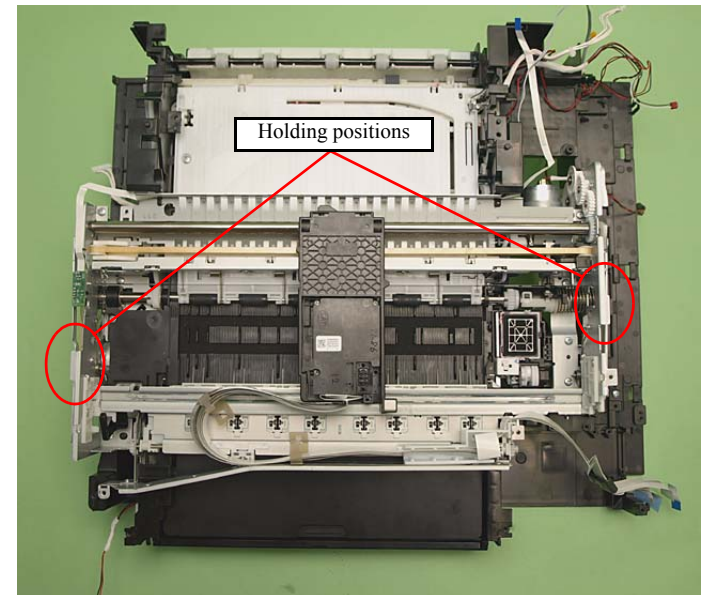


Figure 4-104. Holding positions of Main Frame

1. Release the Plunger cable from the hooks (x10) of the Front Frame. (See Fig. 4-105.)
2. Release the PE Sensor cable from the dowel of the Base Frame. (See Fig. 4-105.)
3. Detach the relay connector of the PE Motor cable from the hole of the Base Frame, and disconnect the connector. (See Fig. 4-105.)

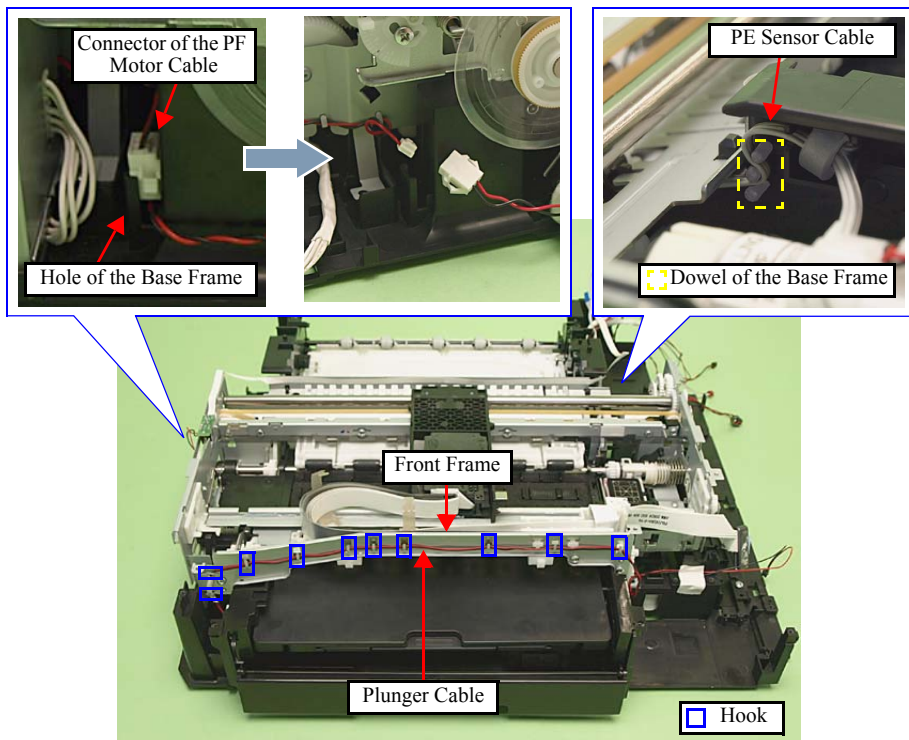


Figure 4-105. Removing the Main Frame (1)



When removing the Main Frame, be careful not to damage the cables and FFCs with the Main Frame.

4. Remove the Grounding Plate B. (See Fig. 4-106.)
5. Remove the screws (x7) that secure the Main Frame, and remove the Main Frame from the Base Frame.

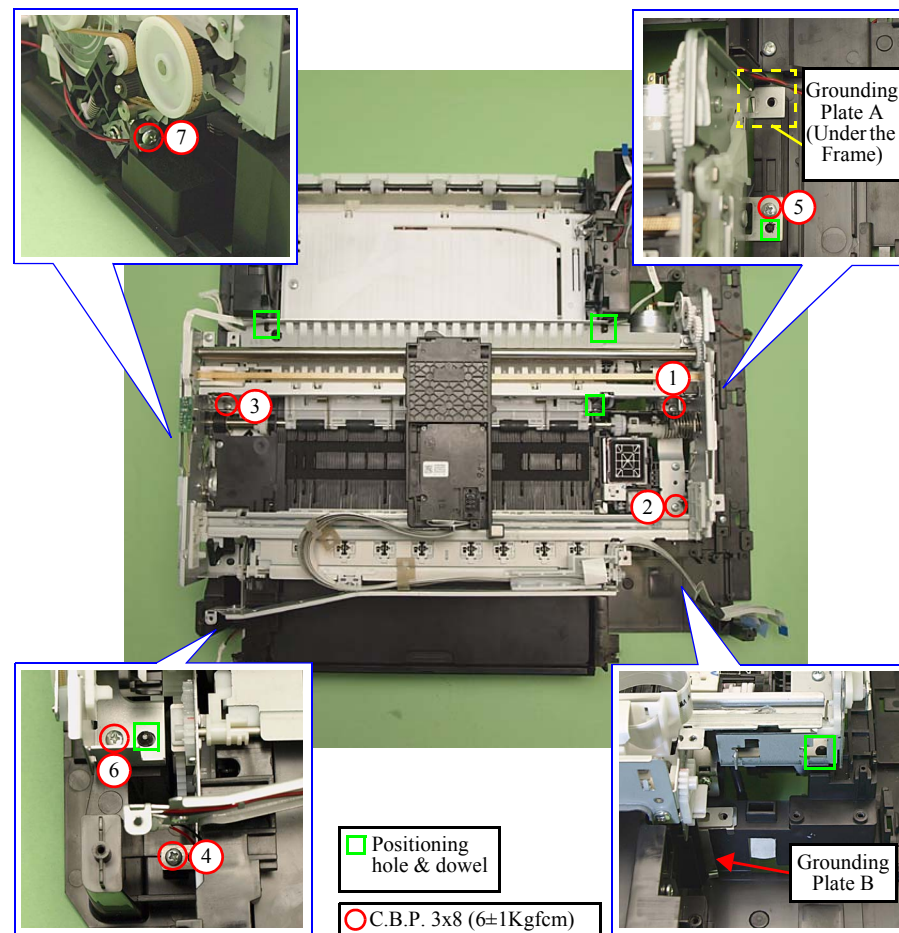


Figure 4-106. Removing the Main Frame (2)

REASSEMBLY



- Attach the Grounding Plate A between the Main Frame and Base Frame. (See Fig. 4-106, Fig. 4-107.)
- When installing the Grounding Plate B, attach the hook of it to the hole of the Base Frame, and place it over the Main Frame. (See Fig. 4-106, Fig. 4-107.)

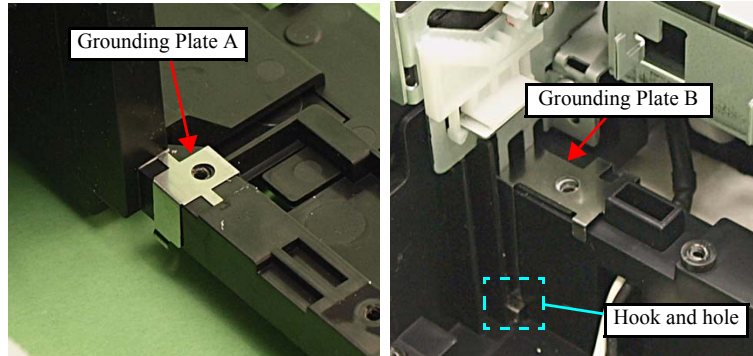


Figure 4-107. Attaching the Grounding Plate

- Align the positioning holes (x6) of the Main Frame with the dowels (x6) of the Base Frame. (See Fig. 4-106)
- Tighten the screws in the order shown in Fig. 4-106.
- For routing the cables, see 4.4 "Routing FFC/cables" (p202).

REASSEMBLY



- When installing the Main Frame, be careful not to let it hit the Base Frame. If the EJ Release Frame Assy L hits the Base Frame (see Fig. 4-113), the gear will come off, which may cause the operation defect.

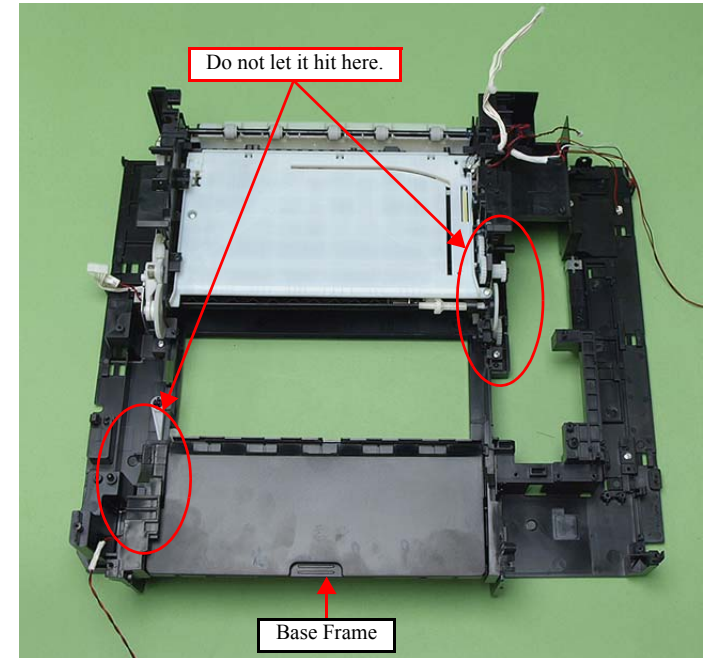


Figure 4-108. Installing the Main Frame

- Tighten the screws in the order shown in Fig. 4-106.
- For routing the cables, see 4.4 "Routing FFC/cables" (p202).

ADJUSTMENT
REQUIRED

After removing the Main Frame, make the specified adjustments. (See Chapter 5 "ADJUSTMENT".)

4.2.4.12 Front Frame

CHECK
POINT

- The Main Frame becomes unstable once it is removed from the Base Frame. Be careful not to deform the frame during performing the following procedures.
- Refer to [4.2.4.11 Main Frame \(p144\)](#) for the Parts/Components need to be removed before removing the Main Frame.

- Parts/Components need to be removed in advance:

Main Frame

- Removal procedure

1. Remove the screw (x1) that secures the FFC Holder, and remove the FFC Holder. (See [Fig. 4-109.](#))
2. Remove the screws (x2) that secure the Front Frame, and remove the Front Frame.

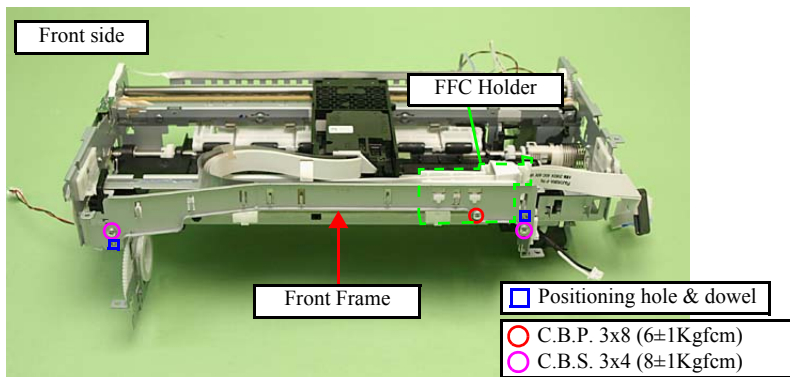


Figure 4-109. Removing the Front Frame

REASSEMBLY



Align the positioning holes (x2) of the Front Frame with dowels (x2) of the Main Frame. (See [Fig. 4-109](#))

4.2.4.13 EJ Frame Assy / EJ Release Frame Assy R/
EJ Release Frame Assy LCHECK
POINT

- The Main Frame becomes unstable once it is removed from the Base Frame. Be careful not to deform the frame during performing the following procedures.
- Refer to [4.2.4.11 Main Frame \(p144\)](#) for the Parts/Components need to be removed before removing the Main Frame.

- Parts/Components need to be removed in advance:

Main Frame/Front Frame

- Removal procedure

1. Remove the securing ring from the EJ Frame Shaft and remove the Spur Gear A. (See [Fig. 4-110.](#))
2. Remove the screw (x1) that secures the EJ Release Frame Assy R, and remove the EJ Release Frame Assy R.

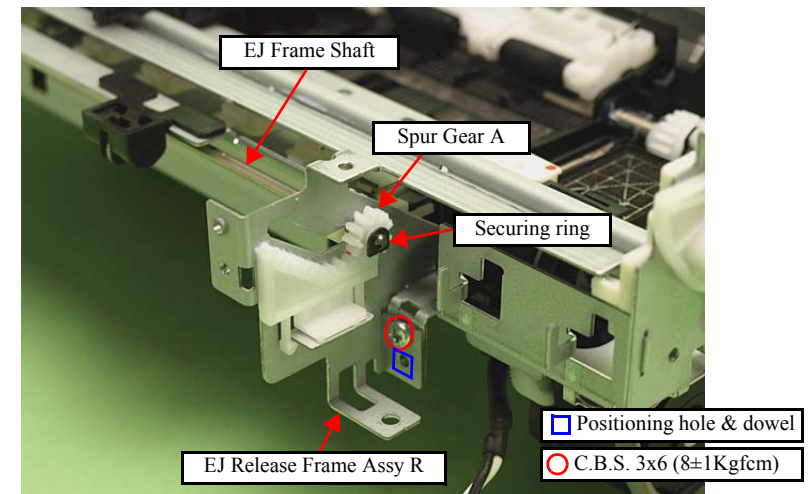


Figure 4-110. Removing the EJ Release Frame Assy R

3. While holding the right side of the EJ Frame Assy, turn the Spur Gear on the left side in the direction of the arrow, and move the EJ Frame Assy to the front side.

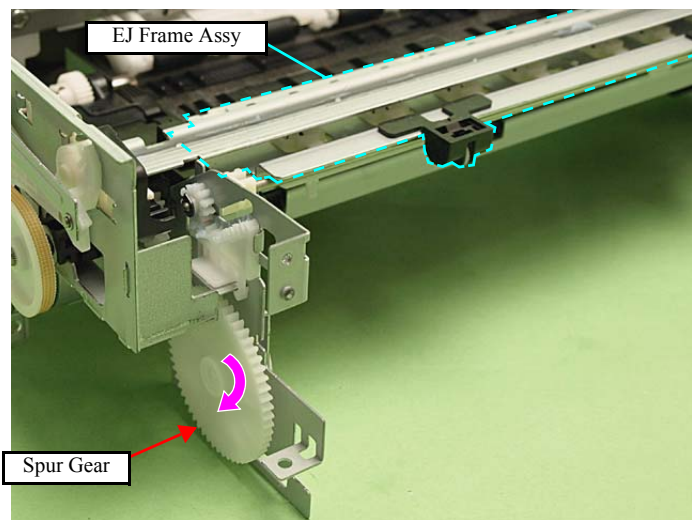


Figure 4-111. Removing the EJ Frame Assy (1)

4. Pull out and remove the EJ Frame Assy from the EJ Frame Shaft.

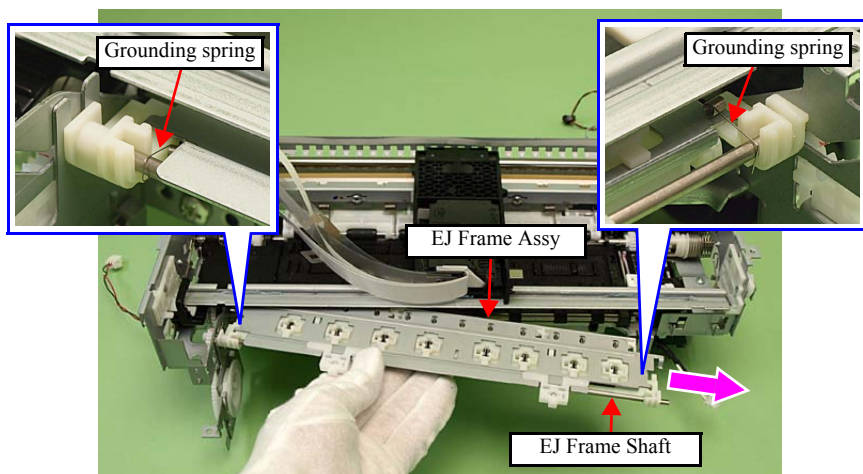


Figure 4-112. Removing the EJ Frame Assy (2)

5. Remove the screw (x1) that secures the EJ Release Frame Assy L and remove the EJ Release Frame Assy L with the EJ Frame Shaft.

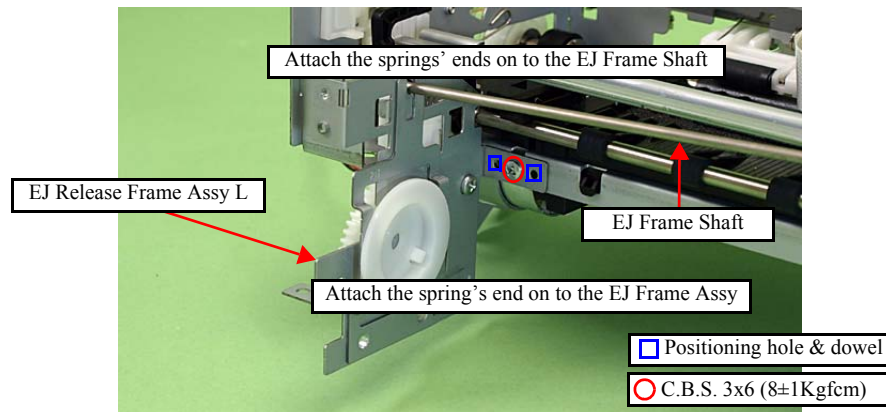


Figure 4-113. Removing the EJ Release Frame Assy L

REASSEMBLY



- Align the dowels (x2) of the EJ Release Frame Assy L with the positioning holes (x2) of the Main Frame. (See Fig. 4-113.)
- Make sure to attach the grounding springs (x2) of the EJ Frame Assy securely to the EJ Frame Shaft. (See Fig. 4-112, Fig. 4-114.)

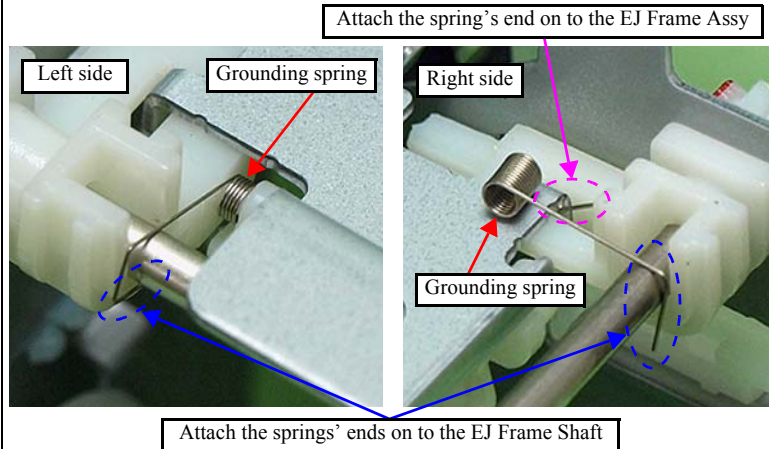


Figure 4-114. Attaching the grounding spring

- Align the dowel (x1) of the EJ Release Frame Assy R with the positioning hole (x1) of the Main Frame. (See Fig. 4-110.)
- When attaching the Spur Gear A, insert the protrusion of the EJ Frame Assy to the hole of the Paper Guide Front Assy.

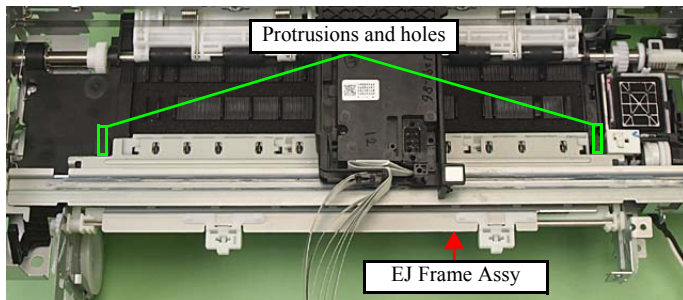


Figure 4-115. Installing the EJ Frame Assy

REASSEMBLY



- After installing the EJ Release Frame Assy L, follow the procedure below to check the movement of the EJ Release Trigger.
 1. Rotate the EJ Roller counterclockwise as seen from the left side, and make the EJ Release Trigger stay on the CR Guide Plate.
 2. Lift the CR Guide Plate slightly and push the EJ Release Trigger to the 80 digit side.
 3. Make sure to engage the Spur Gear of the EJ Release Trigger properly with the Combination Gear of the EJ Release Frame Assy L, and check if the drive force of the PF Motor transmits up to the EJ Frame Assy.

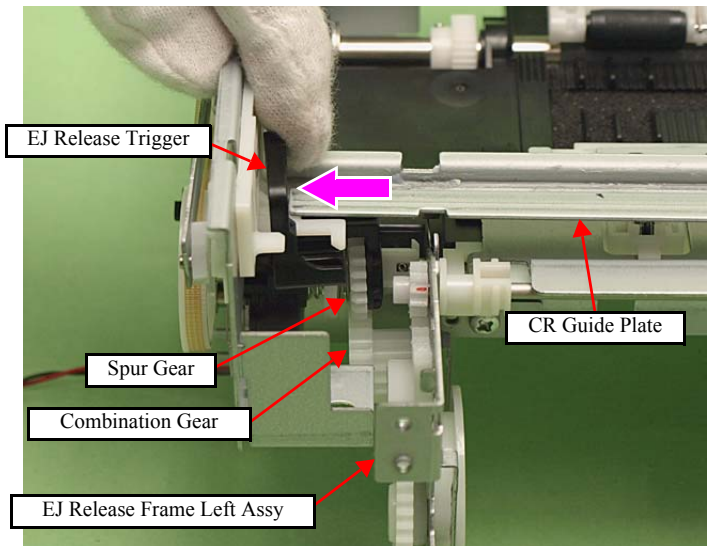


Figure 4-116. Check for EJ Release Trigger movement

ADJUSTMENT
REQUIRED

- After removing the EJ Frame Assy/EJ Release Frame Assy L/R, make the specified adjustments. (See Chapter 5 "ADJUSTMENT".)
- After replacing the EJ Frame Assy/EJ Release Frame Assy L/R, be sure to perform the required lubrication. (See Chapter 6 "MAINTENANCE".)

4.2.4.14 PF Motor

CHECK
POINT

- The Main Frame becomes unstable once it is removed from the Base Frame. Be careful not to deform the frame during performing the following procedures.
- Refer to 4.2.4.11 Main Frame (p144) for the Parts/Components need to be removed before removing the Main Frame.

- Parts/Components need to be removed in advance:

Main Frame

- Removal procedure

CAUTION



- Be careful not to touch the PF Scale with bare hands.
- Be careful not to damage or contaminate the PF Scale.
- Be careful not to lose the Driven Pulley Shaft.

1. Push the Tensioner in the direction of the arrow and remove the PF Timing Belt.

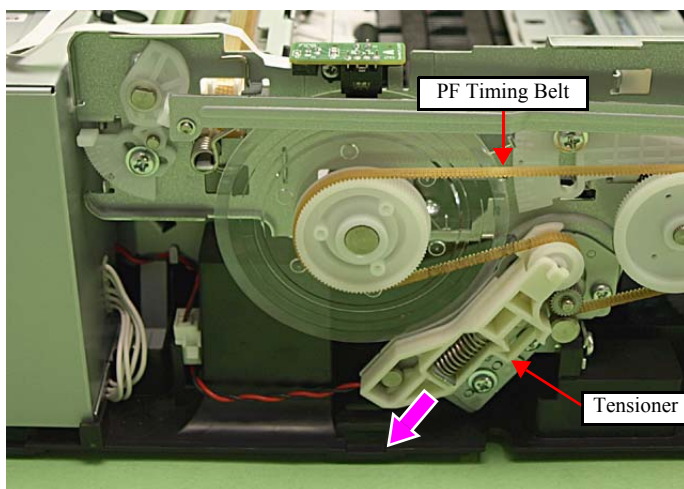


Figure 4-117. Removing the PF Timing Belt

2. Remove the screw (x1) that secures the Spacer, and remove the Spacer. (See Fig. 4-118.)
3. Remove the Compression Spring.

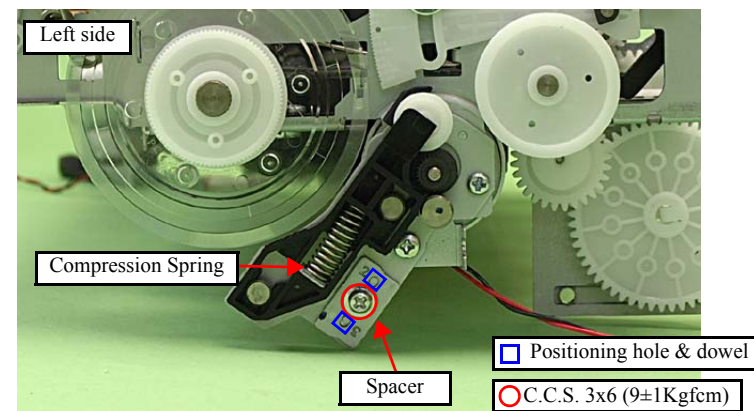


Figure 4-118. Removing the PF Motor (1)

4. Remove the Tensioner together with the Driven Pulley.

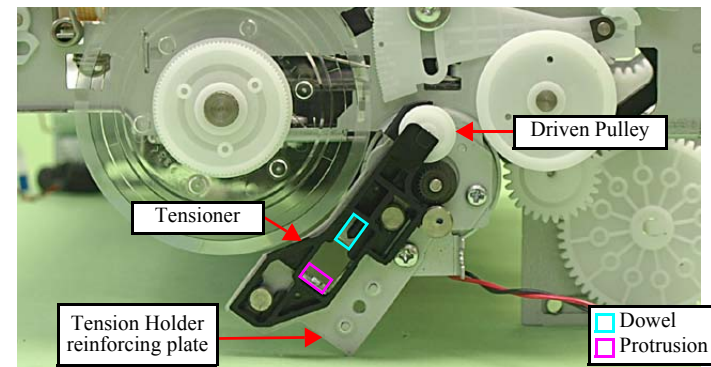


Figure 4-119. Removing the PF Motor (2)

CAUTION

Be careful not to damage the Pinion Gear of the PF Motor.

- Remove the screws (x2) that secure the Tension Holder reinforcing plate and remove the Holder.

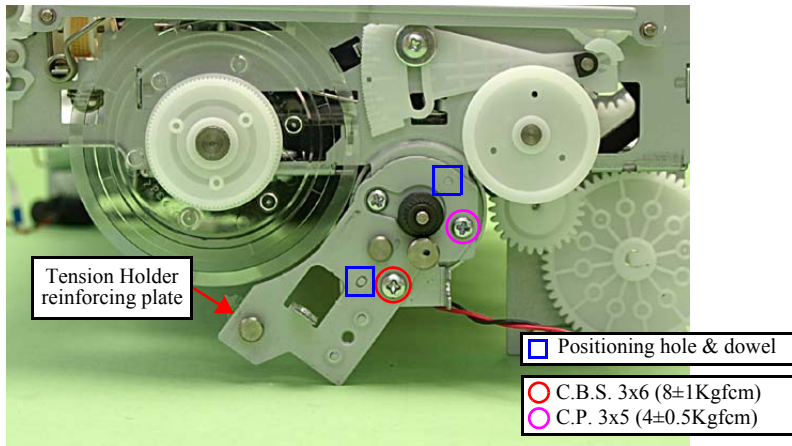


Figure 4-120. Removing the PF Motor (3)

- Remove the screw (x1) that secures the PF Motor, and remove the PF Motor while drawing out the Pinion Gear from the hole of the Main Frame.

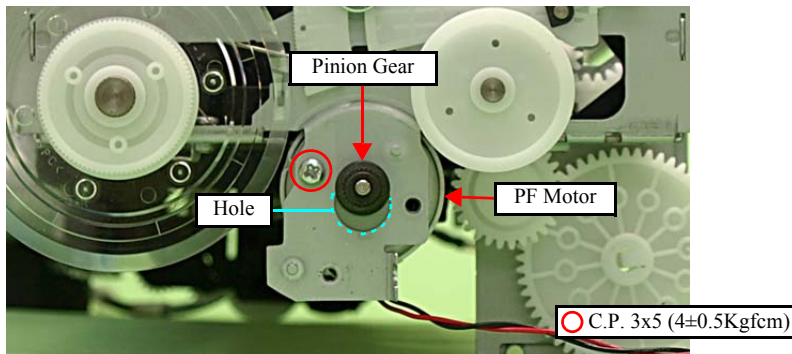


Figure 4-121. Removing the PF Motor (4)

REASSEMBLY



- When installing the PF Motor, keep the groove of the PF Motor upward.

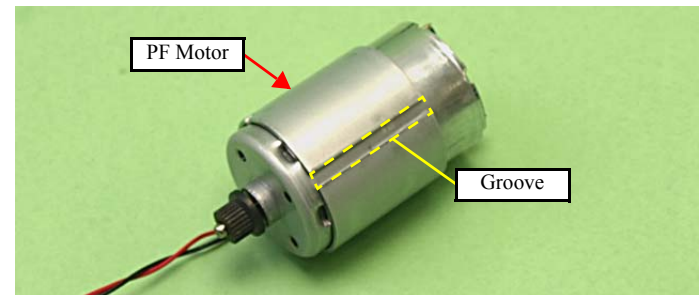


Figure 4-122. Installing the PF Motor

- When installing the Spacer, align the positioning holes (x2) of the Spacer with the dowels (x2) of the Holder. Make sure there is no gap between upper left end of the Spacer and the Tensioner. If there is a gap, turn the Spacer around or over so that another letter (2, 4, or 1) comes to the upper left and install it. (See Fig. 4-118 and Fig. 4-123.)

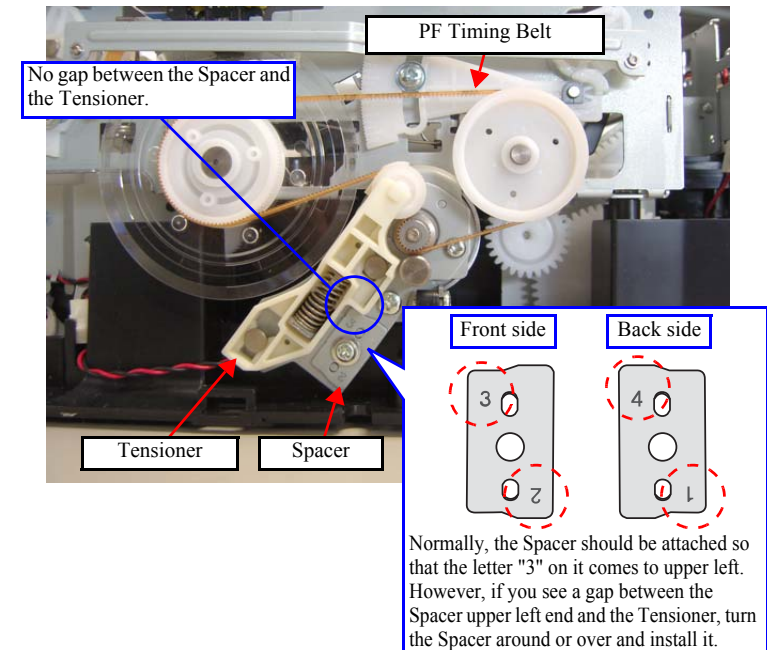


Figure 4-123. Installing the Spacer

REASSEMBLY

- Align the positioning holes (x2) of the Holder with the dowels (x2) of the Main Frame. (See Fig. 4-120.)
- Insert the Compression Spring to the dowel of the Tensioner and attach it to the protrusion of the Tension Holder reinforcing plate. (See Fig. 4-119.)

**ADJUSTMENT
REQUIRED**

- After removing/replacing the PF Motor, make the specified adjustments. (See Chapter 5 "ADJUSTMENT".)
- After replacing the PF Motor, be sure to perform the required lubrication. (See Chapter 6 "MAINTENANCE".)

4.2.4.15 CR Motor**CHECK
POINT**

- The Main Frame becomes unstable once it is removed from the Base Frame. Be careful not to deform the frame during performing the following procedures.
- Refer to 4.2.4.11 Main Frame (p144) for the Parts/Components need to be removed before removing the Main Frame.

- Parts/Components need to be removed in advance:
 - Main Frame
- Removal procedure
 1. Loosen the CR Timing Belt, and detach the CR Timing Belt from the Pinion Gear of the CR Motor. (See 4.2.4.16 Carriage Unit Step2 - Step4 (p155).)
 2. Remove the securing ring that secures the Spur Gear A, and remove the Spur Gears (A, B) and Combination Gear (x1).

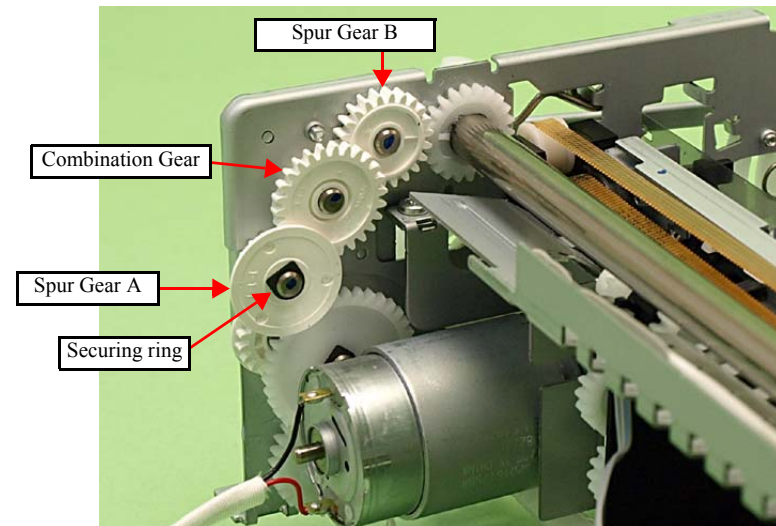


Figure 4-124. Removing the CR Motor (1)

3. Loosen the screw (x1) that secures the Parallelism Bushing. (See Fig. 4-125.)
4. Lift the PG Lever R and disengage the dowel of the Main Frame from the shaft hole of the Parallelism Bushing. (See Fig. 4-125.)
5. Rotate the Parallelism Bushing till the screw that secures the CR Motor Assy can be seen.

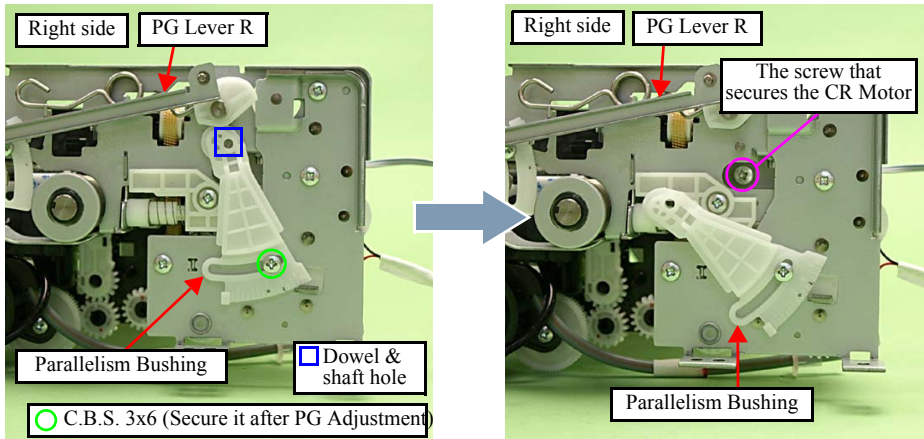


Figure 4-125. Removing the CR Motor (2)

6. Remove the screws (x4) that secure the CR Motor, and remove the CR Motor Assy.

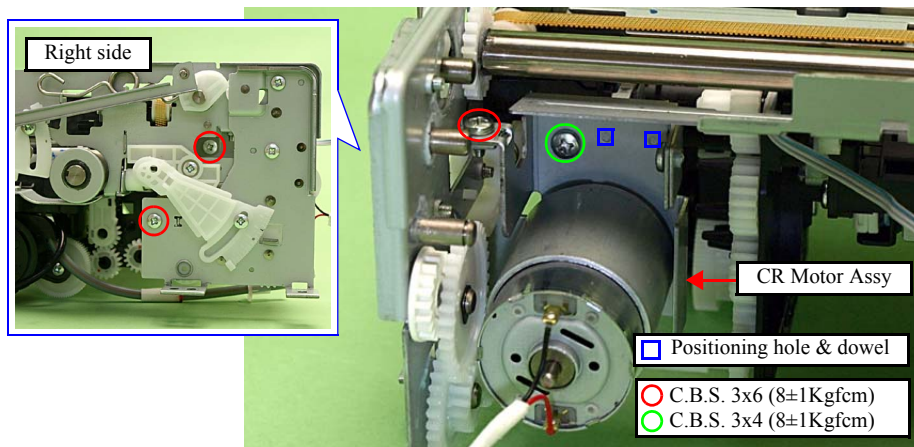


Figure 4-126. Removing the CR Motor (2)



Be careful not to damage the Pinion Gear of the CR Motor with the CR Motor Holder.

7. Remove the screws (x2) that secure the CR Motor, and remove the CR Motor from the CR Motor Holder.

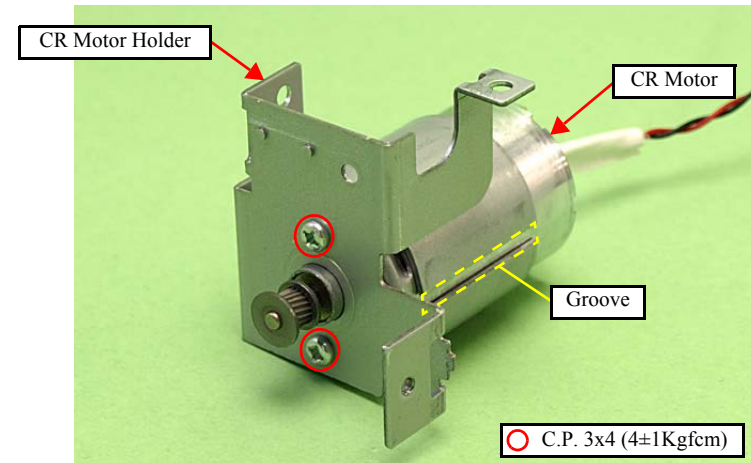


Figure 4-127. Removing the CR Motor (3)

REASSEMBLY



- When installing the CR Motor, install it with the groove of the CR Motor as shown in Fig. 4-127.
- Align the dowels (x2) of the CR Motor Holder with the positioning holes (x2) of the Main Frame. (See Fig. 4-126.)
- Phase adjustment of the Spur Gear
 - Align the point B of the Spur Gear B with the point C of the Spur Gear C to make the phases of both gears match.

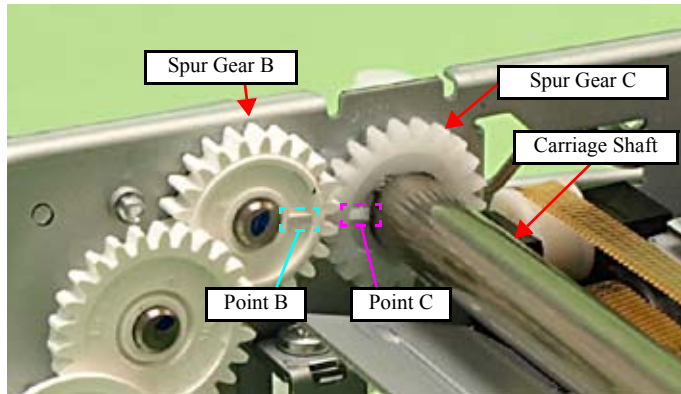


Figure 4-128. Aligning the Spur Gear

ADJUSTMENT
REQUIRED

- After removing/replacing the CR Motor, make the specified adjustments. (See Chapter 5 "ADJUSTMENT".)
- After replacing the CR Motor, be sure to perform the required lubrication. (See Chapter 6 "MAINTENANCE".)

4.2.4.16 Carriage Unit

CHECK
POINT

- The Main Frame becomes unstable once it is removed from the Base Frame. Be careful not to deform the frame during performing the following procedures.
- Refer to 4.2.4.11 Main Frame (p144) for the Parts/Components need to be removed before removing the Main Frame.

- Parts/Components need to be removed in advance:

Main Frame/Printhead/CR Scale

- Removal procedure

1. Remove the screw (x1) that secures the FFC Holder and remove the FFC Holder. (See 4.2.4.12 Front Frame Step1 (p147).)

CAUTION



- Be careful not to lose the Driven Pulley Shaft.
- Take extra care not to contaminate the CR Timing Belt with grease on the CR Guide Plate or the Carriage Shaft after removing the CR Timing Belt from the Main Frame.

2. Remove the Extension spring 25.63 under the Driven Pulley Assy with longnose pliers, and remove the Driven Pulley Assy from the Main Frame. (See Fig. 4-129.)
3. Remove the Driven Pulley from the Driven Pulley Assy, and detach the CR Timing Belt.

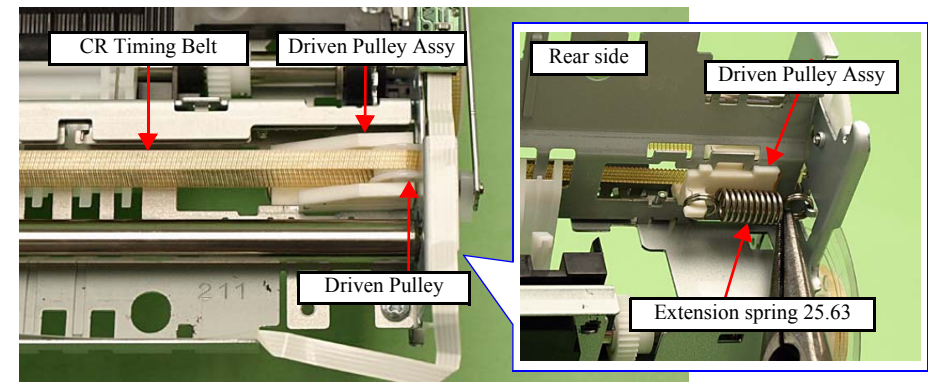


Figure 4-129. Removing the Driven Pulley Assy

4. Detach the CR Timing Belt from the CR Motor.

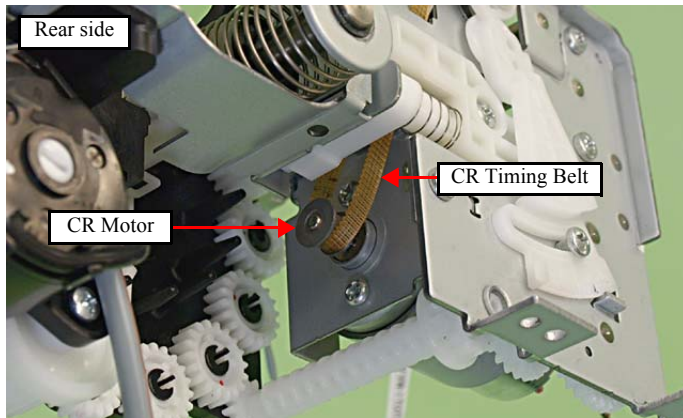


Figure 4-130. Removing the CR Timing Belt

CAUTION



Be careful not to lose the Driven Pulley Shaft.

5. Remove the screw (x1) that secures the Driven Pulley Timing Assy, and remove the Driven Pulley Timing Assy. (See Fig. 4-131.)
6. Remove the Driven Pulley from the Driven Pulley Timing Assy, and remove the CR Timing Belt.

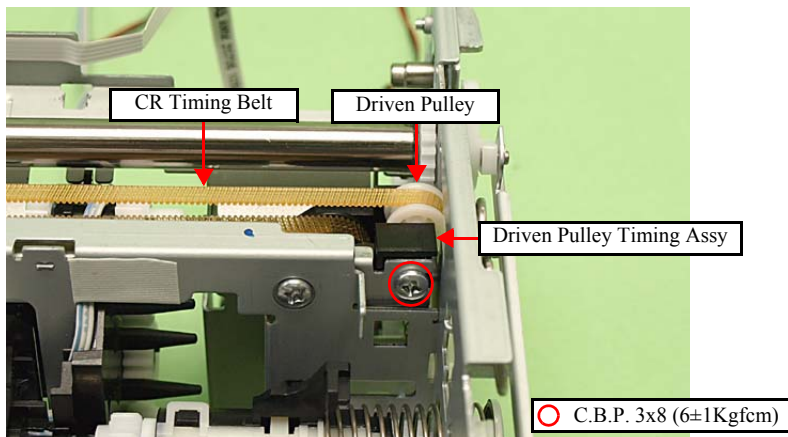


Figure 4-131. Removing the Driven Pulley Timing Assy

7. Remove the Frame Sheet from the Main Frame.
8. Remove the E-ring and remove the PG Lever R. (See Fig. 4-132.)
9. Remove the Torsion Spring R.

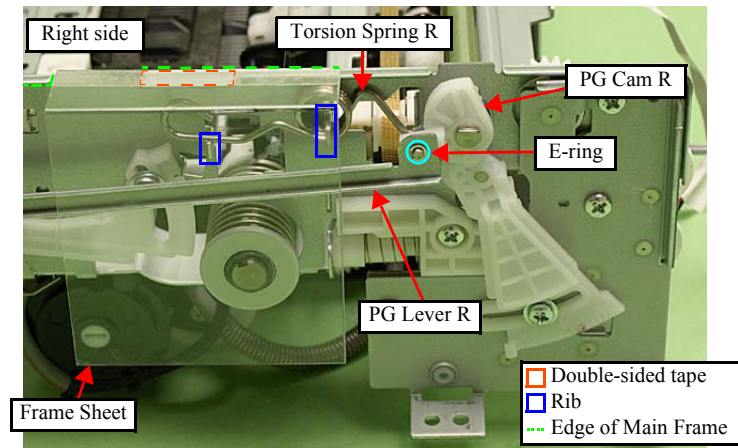


Figure 4-132. Removing the Carriage Unit (1)

10. Remove the securing ring that secure the PG Cam R and remove the PG Cam R. (See Fig. 4-135.)
11. Remove the Flat Washer and the Spring Washer.

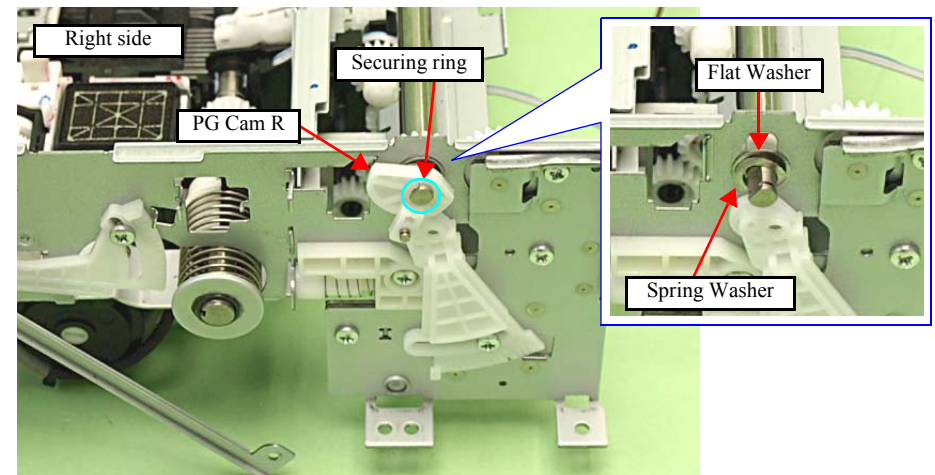


Figure 4-133. Removing the Carriage Unit (2)

CAUTION

- Be careful not to touch the PF Scale with bare hands.
- Be careful not to damage or contaminate the PF Scale.

12. Remove the E-ring and remove the PG Lever L.

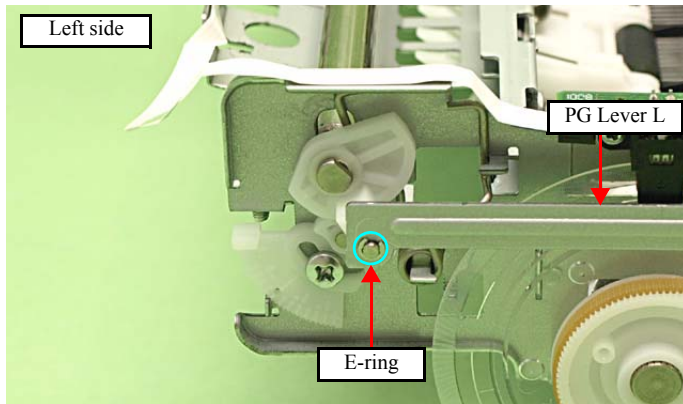


Figure 4-134. Removing the Carriage Unit (3)

13. Removing the Torsion Spring L. (See Fig. 4-135.)

14. Remove the securing ring that secures the PG Cam L and remove the PG Cam L.

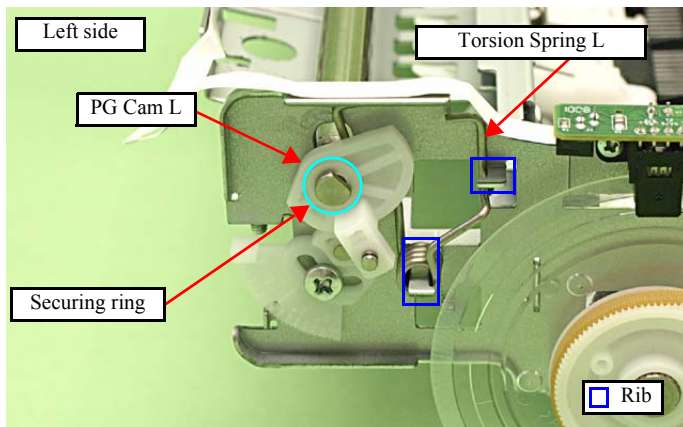


Figure 4-135. Removing the Carriage Unit (4)

CAUTION

- Be careful not to damage the Carriage Shaft with the Frame.

15. Move the Carriage Unit to the 80 digit side, and lift the Carriage Unit at the cutout of the CR Guide Plate, and remove the point A on the rear of the Carriage Unit from the CR Guide Plate.

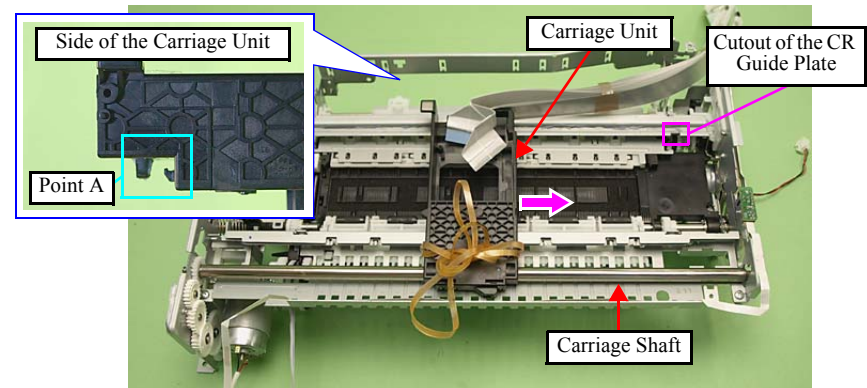


Figure 4-136. Removing the Carriage Unit (5)

16. Move the Carriage Unit to the center.

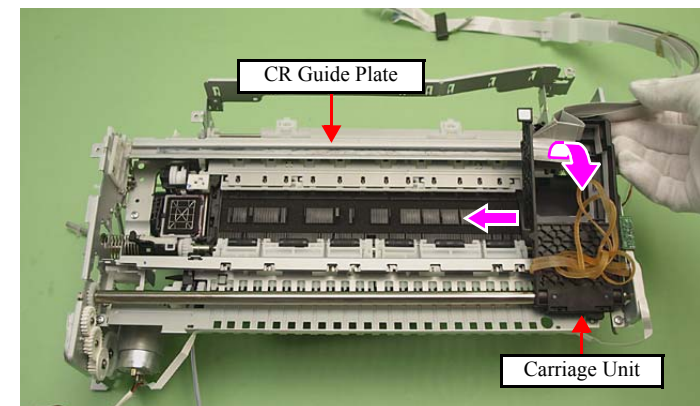


Figure 4-137. Removing the Carriage Unit (6)

17. Slide the Carriage Shaft to the 80 digit side, and detach the point B of the Carriage Shaft from the Main Frame, and remove the Carriage Unit together with the CR Timing Belt and the Carriage Shaft.

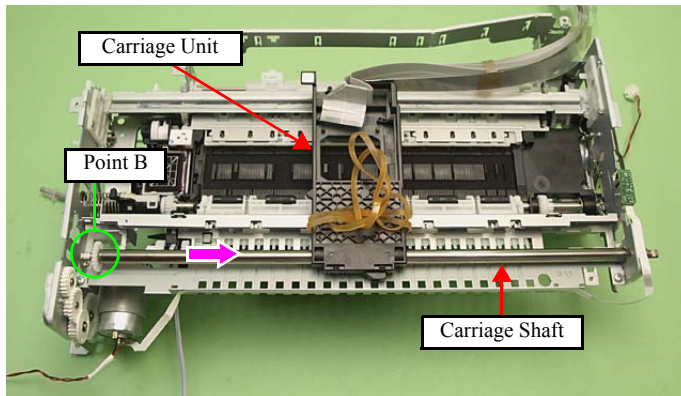


Figure 4-138. Removing the Carriage Unit (7)



- Align the point A on the rear of the Carriage Unit with the cutout of the CR Guide Plate to install the Carriage Unit. (See Fig. 4-136.)
- When installing the Flat Washer and the Spring Washer, install them in the order of the Flat Washer and the Spring Washer from the frame side. (See Fig. 4-133.)
- When installing the Torsion Spring R, hook the spring leg between PG Cam R and the Spring Washer, and attach the spring to the ribs (x2) of the Main Frame. (See Fig. 4-132, Fig. 4-133.)
- When installing the Torsion Spring L, hook the spring leg between PG Cam L and the Main Frame, and attach it to the ribs (x2) of the Main Frame. (See Fig. 4-135.)
- When installing the Frame Sheet, attach it with double-sided tape while aligning it with the edge of the Main Frame. (See Fig. 4-132.)



- When replacing the CR Timing Belt, insert the CR Timing Belt to the Timing Belt Holder, and install it to the Carriage Unit as shown in Fig. 4-139.

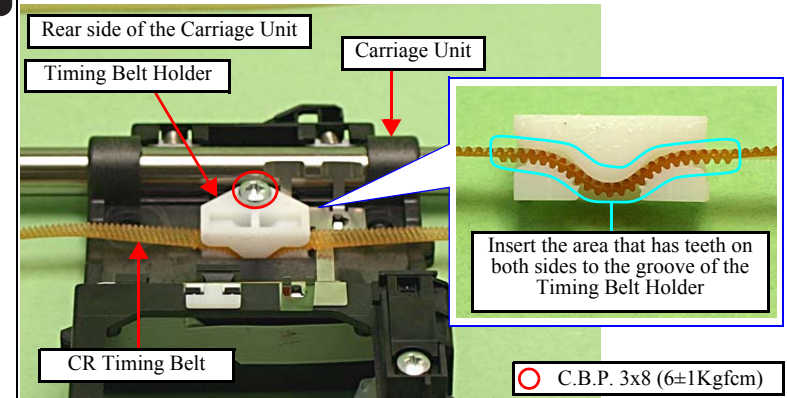


Figure 4-139. Installing the CR Timing Belt (1)



- After removing/replacing the Carriage Unit, make the specified adjustments. (See Chapter 5 "ADJUSTMENT".)
- After replacing the Carriage Unit, be sure to perform the required lubrication. (See Chapter 6 "MAINTENANCE".)

4.2.4.17 Transmission Holder Assy

CHECK
POINT

- The Main Frame becomes unstable once it is removed from the Base Frame. Be careful not to deform the frame during performing the following procedures.
- Refer to [4.2.4.11 Main Frame \(p144\)](#) for the Parts/Components need to be removed before removing the Main Frame.

- Parts/Components need to be removed in advance:

Main Frame/Printhead/CR Scale/Carriage Unit/Ink System

- Removal procedure

1. Push the Switch Lever in the direction of the arrow and disengage the Transmission Arm from the Transmission Holder Assy. (See [Fig. 4-86](#), [Fig. 4-140](#).)
2. Remove the screw (x1) that secures the Transmission Holder Assy. (See [Fig. 4-140](#).)
3. Release the PE Sensor Cable from the Transmission Holder Assy, and remove the Transmission Holder Assy.

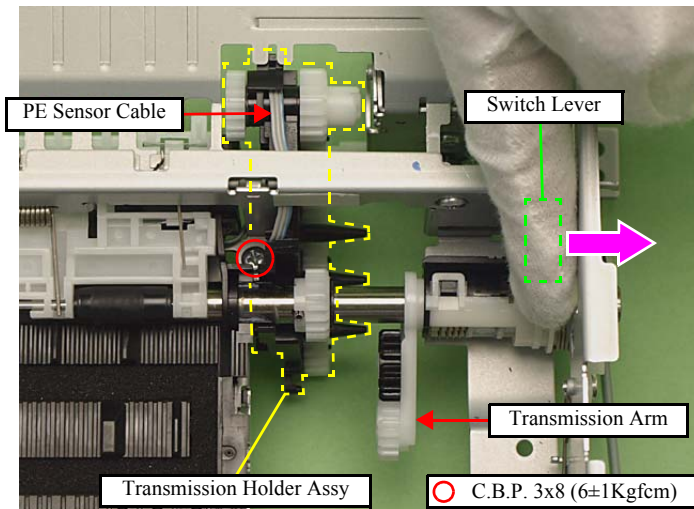


Figure 4-140. Removing the Transmission Holder Assy



- Make sure that all gears on the Transmission Holder Assy are properly installed to the hooks and move smoothly.

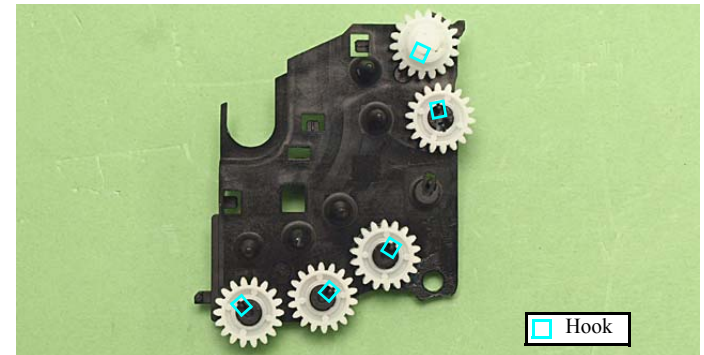


Figure 4-141. Installing the Transmission Holder Assy (1)

- When assembling the Transmission Holder Assy, align the hooks (x3) of the Transmission Holder Assy with the ribs (x3) of the Main Frame.

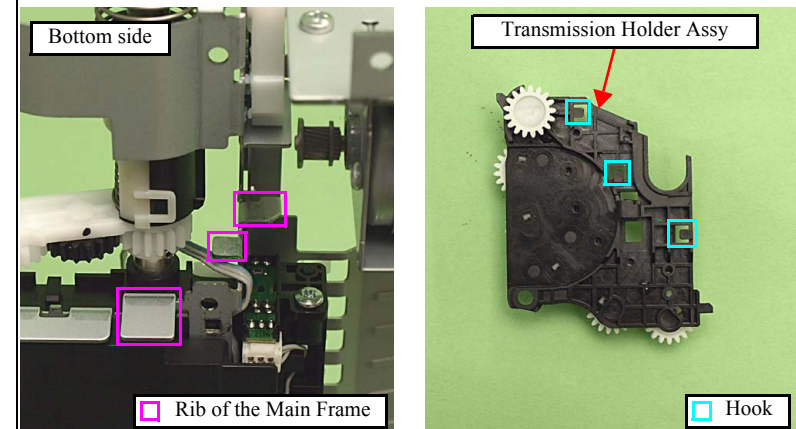


Figure 4-142. Installing the Transmission Holder Assy (2)

- For routing the FFCs, see [4.4 "Routing FFC/cables" \(p202\)](#).

4.2.4.18 Rear Frame

CHECK
POINT

- The Main Frame becomes unstable once it is removed from the Base Frame. Be careful not to deform the frame during performing the following procedures.
- Refer to 4.2.4.11 Main Frame (p144) for the Parts/Components need to be removed before removing the Main Frame.

- Parts/Components need to be removed in advance:

Main Frame/Printhead/CR Scale/Carriage Unit/Front Frame/Ink System/
Transmission Holder Assy

- Removal procedure

CAUTION



Deformed antistatic cloth attached on the Rear Frame will cause ink mist adhering to the print surface; therefore, make sure not to touch the antistatic cloth.

If it is deformed, make sure to repair it so as to let it touch the paper as shown in below figure.

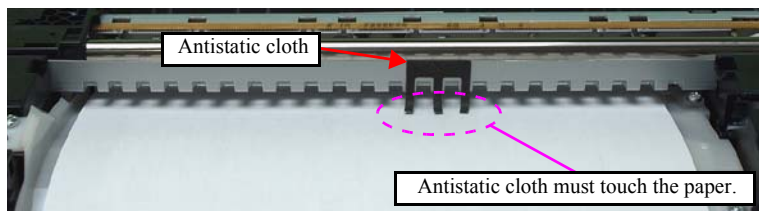
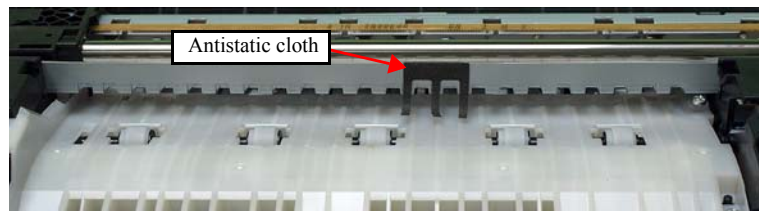


Figure 4-143. Position of the antistatic cloth

1. Peel off the PF Encoder FFC from the Rear Frame. (See Fig. 4-144.)
2. Remove the Torsion Spring A (x4), B (x2) and C (x2). (See Fig. 4-144.)
3. Remove the Spur Gears (x2) and Combination Gear (x1). (See 4.2.4.15 CR Motor Step2 (p152).)

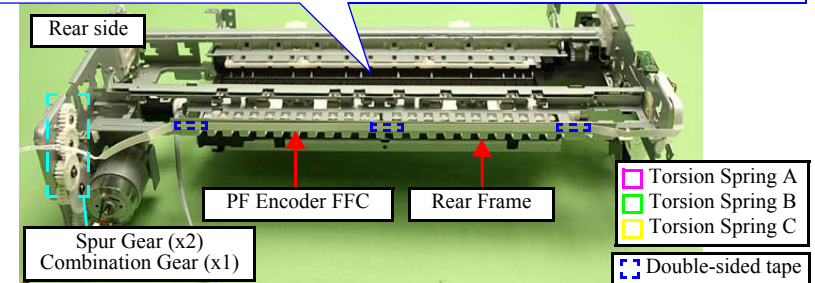
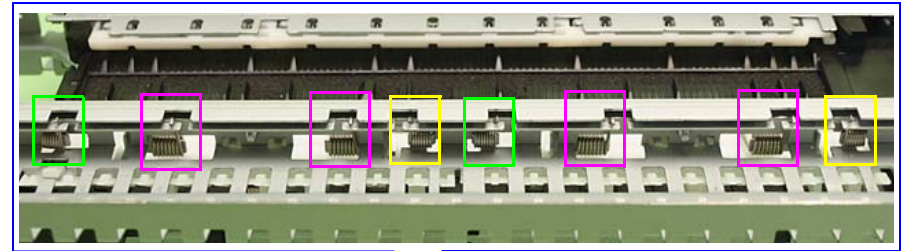


Figure 4-144. Removing the Rear Frame (1)

- Remove the screws (x5) that secure the Rear Frame and the screws (x2) that secure the CR Motor Holder, and remove the Rear Frame together with the CR Motor Holder. (See Fig. 4-127, Fig. 4-145.)

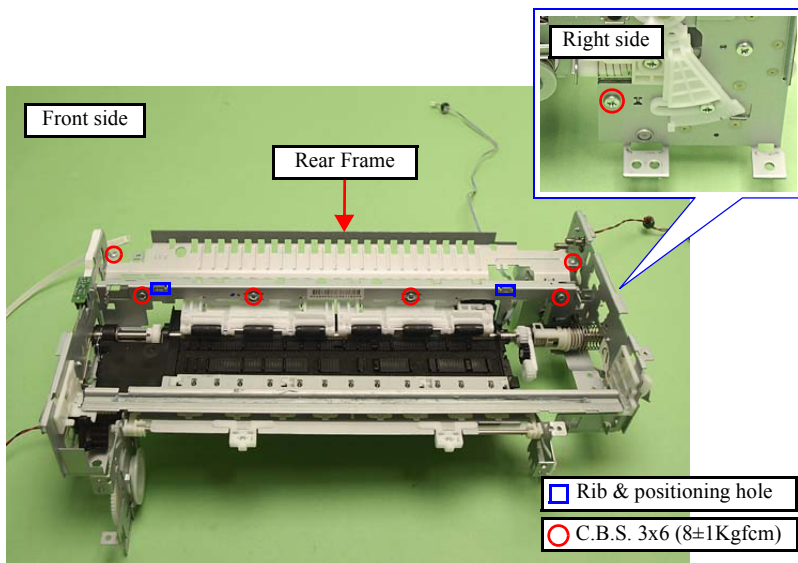


Figure 4-145. Removing the Rear Frame (2)



- Align the ribs (x2) of the Rear Frame with the positioning holes (x2) of the Main Frame. (See Fig. 4-145.)
- Take care of the following points when installing the Torsion Spring A, B and C.
 - Attach the Torsion Spring A (x4) to the ribs of the Main Frame.
 - Attach the Torsion Spring B (x2) and C (x2) to the ribs of the Rear Frame.
 - Align and attach the straight legs of the springs to the groove of the Upper Paper Guide L/R.
 - Attach the hook-shaped legs to the hooks of the Rear Frame.

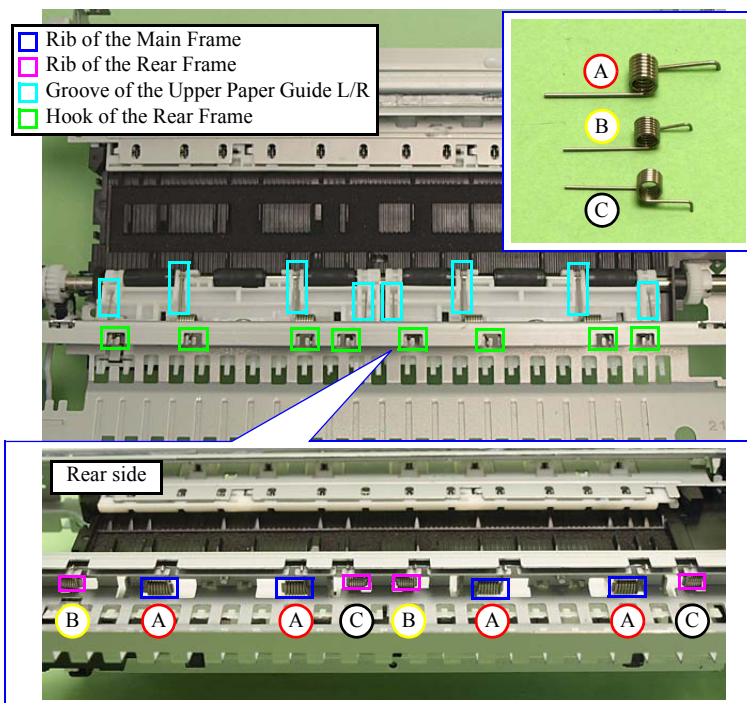


Figure 4-146. Attaching the Torsion Spring

4.2.4.19 Upper Paper Guide L/R / PE Sensor

CHECK
POINT



- The Main Frame becomes unstable once it is removed from the Base Frame. Be careful not to deform the frame during performing the following procedures.
- Refer to [4.2.4.11 Main Frame \(p144\)](#) for the Parts/Components need to be removed before removing the Main Frame.

- Parts/Components need to be removed in advance:

Main Frame/Printhead/CR Scale/Carriage Unit/Ink System/Transmission Holder Assy/Front Frame/Rear Frame/Lower Paper Guide Waste Ink Pad Assy

- Removal procedure

CAUTION



Be careful not to touch or damage the roller of the Upper Paper Guide L/R, or it can adversely affect print quality.

- Upper Paper Guide L

1. Release the hooks (x2) of the Main Frame, and remove the Upper Paper Guide L in the direction of the arrow.

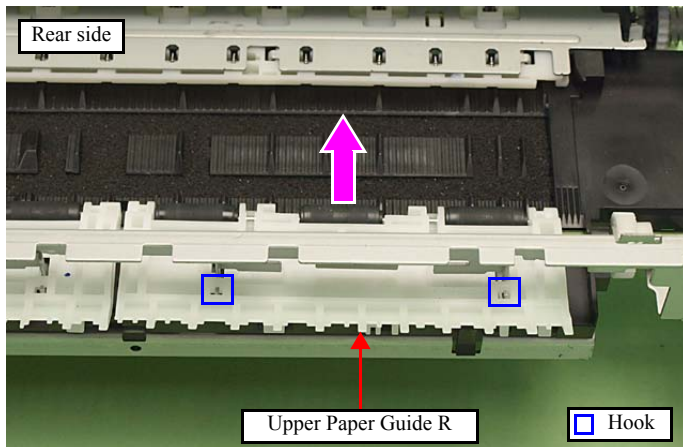


Figure 4-147. Removing the Left Paper Guide

- Upper Paper Guide R/PE Sensor

1. Remove the screw (x1) that secures the Sub Transmission Cam Holder and remove the Sub Transmission Cam Holder.

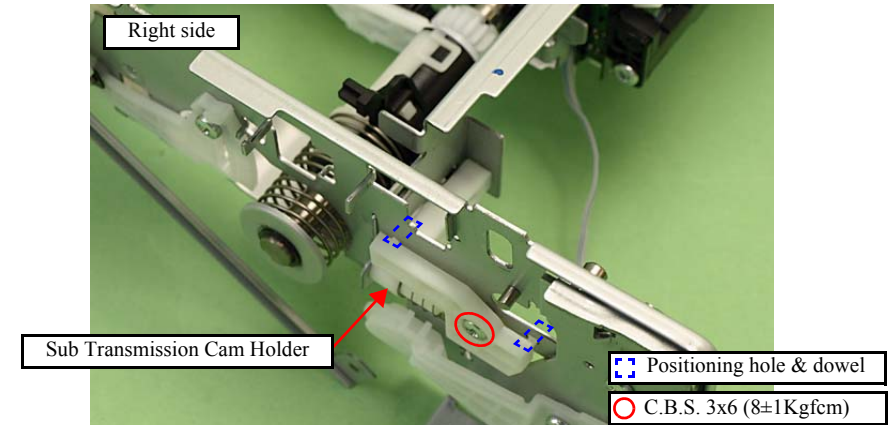


Figure 4-148. Removing the Upper Paper Guide R/PE Sensor

2. Disconnect the PE Sensor cable from the connector. (See [Fig. 4-149.](#))
3. Remove the screw (x1) that secures the PE Sensor, and remove the PE Sensor avoiding the damage to the Upper Paper Guide sheet.

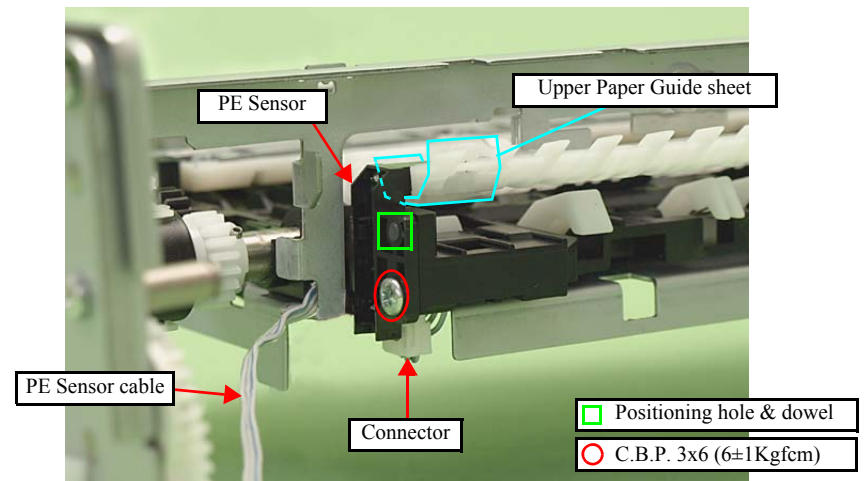


Figure 4-149. Removing the PE Sensor

4. Release the hooks (x2) of the Main Frame and remove the Upper Paper Guide R in the direction of the arrow.

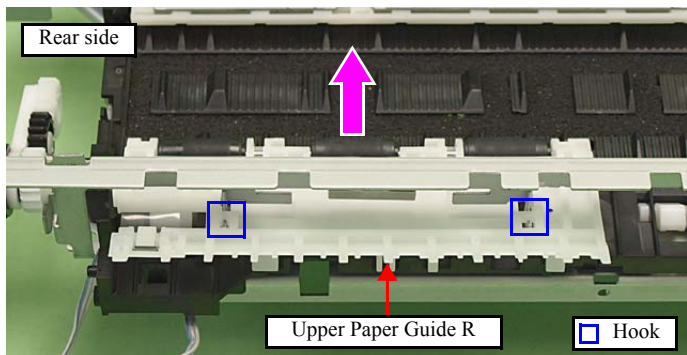


Figure 4-150. Removing the Upper Paper Guide R



- Align the positioning hole of the PE Sensor with the dowel of the Paper Guide Front Assy. (See Fig. 4-149.)
- When installing the PE Sensor, insert the sensor with the Upper Paper Guide sheet in between. (See Fig. 4-149, Fig. 4-151.)

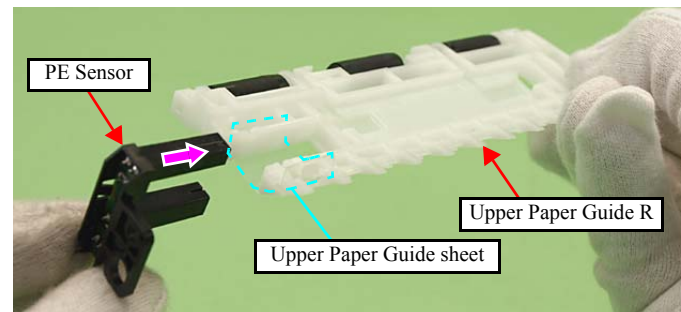


Figure 4-151. Installing the PE Sensor

- The roller of the Upper Paper Guide R in the figure below only is installed in the opposite direction; therefore, make sure to install it properly when the roller comes off.

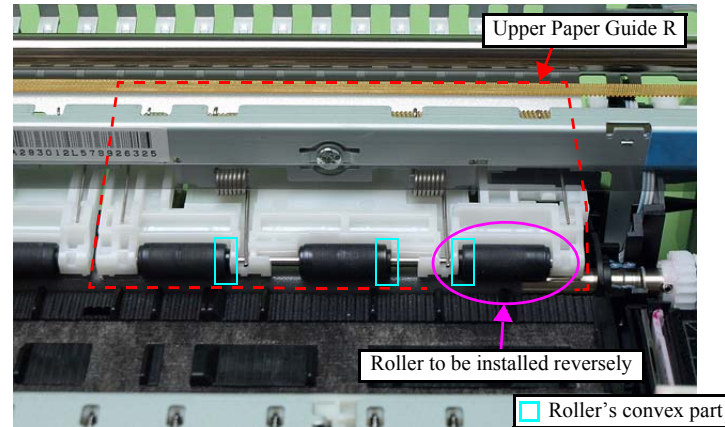


Figure 4-152. Installing the roller

REASSEMBLY



- Align the dowels (x2) of the Sub Transmission Cam Holder with the positioning holes (x2) of the Main Frame. (See Fig. 4-148.)
- Align the protrusion of the Transmission Arm with the groove of the Sub Transmission Cam Holder. (See Fig. 4-153.)
- After installing the Sub Transmission Cam Holder, follow the procedure below to check the movement of the Sub Transmission Cam Holder.
 1. Slide the switch lever to the 0 digit side to check if the point A of the Sub Transmission Cam Holder locks the protrusion of the Transmission Arm, and the arm moves to the middle.
 2. By sliding the switch lever further to the 0 digit side, check if the lock is released and the Sub Transmission Cam Holder returns to the regular position when letting go of the change lever.

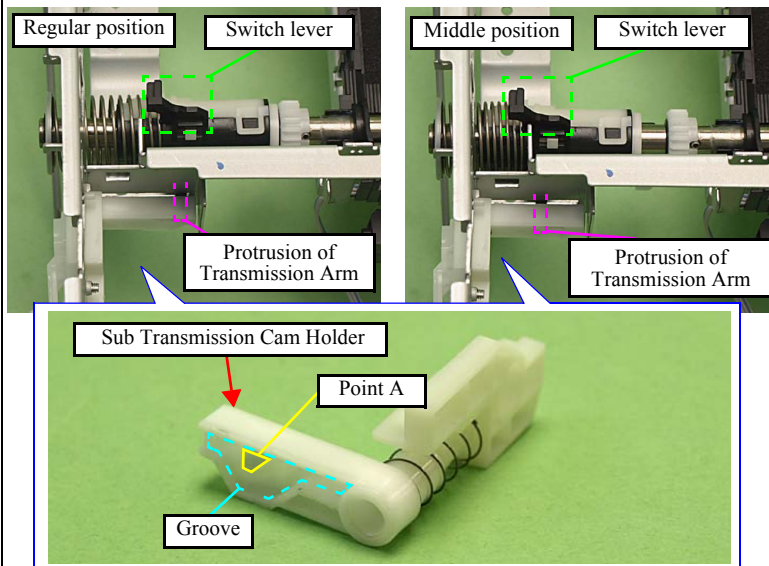


Figure 4-153. Installing the Sub Transmission Cam Holder

ADJUSTMENT
REQUIRED

After removing/replacing the Upper Paper Guide L/R, make the specified adjustments. (See Chapter 5 "ADJUSTMENT".)

4.2.4.20 Waste Ink Tray Assy

- Parts/Components need to be removed in advance:
 - None
- Removal procedure

CAUTION



- So as to make description easier, the printer in the photographs is placed vertically in the following steps. Be careful about ink spilling if the printer is tilted in practical operation.
- Be careful not to get injured with the sharp edges of the grounding plate of the Waste Ink Tray Assy.

1. Remove the screw (x1). (See Fig. 4-154.)
2. Insert the flathead screwdriver to the hole of the Rear Right FAX Housing to release the hook (x1), and remove the Waste Ink Tray Assy. (See Fig. 4-154, Fig. 4-155.)

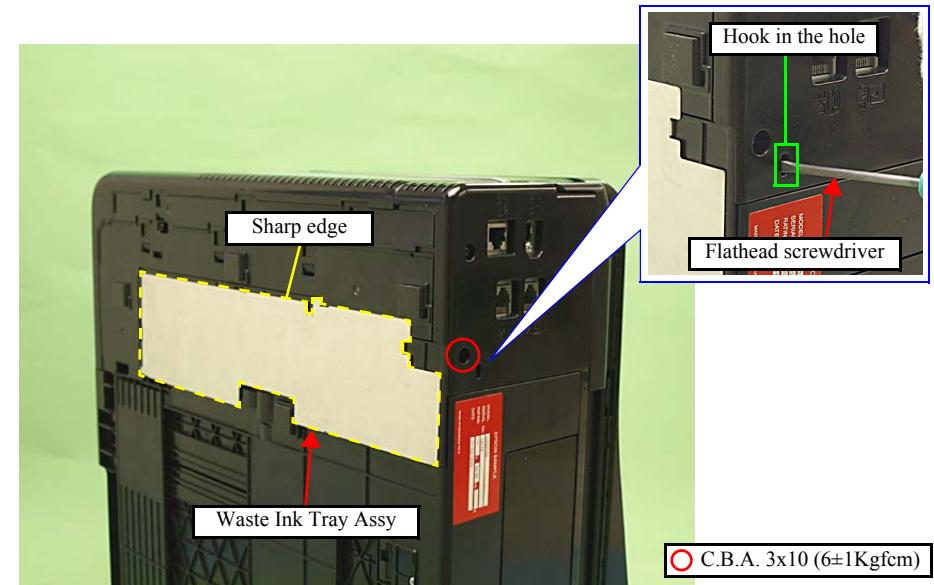


Figure 4-154. Removing the Waste Ink Tray Assy (1)



Be careful about ink spilling from the Waste Ink Tube.

- Remove the Waste Ink Tube from the Waste Ink Cover together with the Tube Stopper, and remove the Waste Ink Tray Assy.

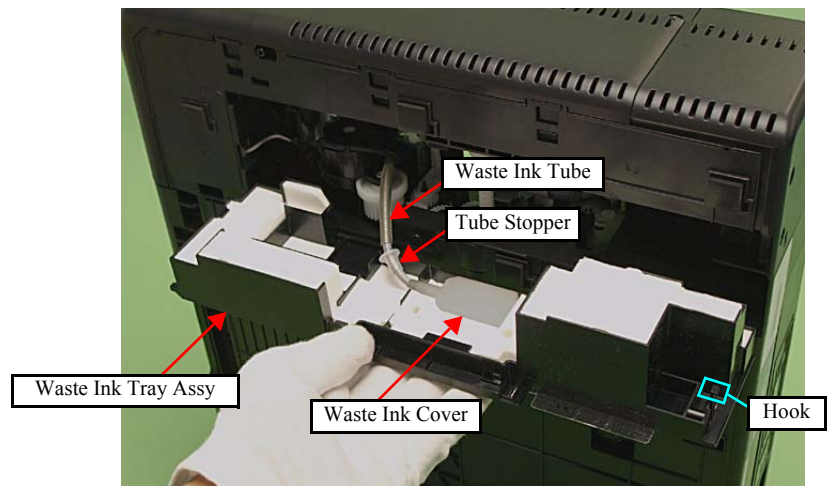


Figure 4-155. Removing the Waste Ink Tray Assy (2)



Following the standard below, attach the Tube Stopper to the Waste Ink Tube, and insert the tube properly to the hole of the Waste Ink Cover. (See Fig. 4-155, Fig. 4-156.)

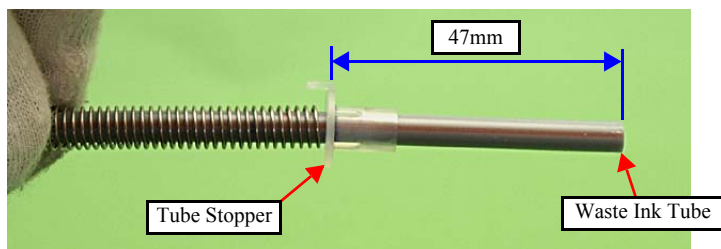


Figure 4-156. Attaching the Waste Ink Tube



■ The Waste Ink Tray Assy includes below waste ink pads.

Location	ASP Name	Qty.
A	POROUS PAD,INK EJ,FRONT,LOWER	1
B	POROUS PAD,INK EJ,LOWER	1
C	POROUS PAD,INK EJ,LEFT	2
D	POROUS PAD,INK EJ,FRONT,2	2
E	POROUS PAD,INK EJ,BOTTOM	1
F	POROUS PAD,INK EJ,BOTTOM,2	1
G	POROUS PAD,INK EJ,FRONT,VERTICAL,1	2
H	POROUS PAD,INK EJ,FRONT,VERTICAL,2	1
I	POROUS PAD,INK EJ,FRONT,VERTICAL,3	1
J	POROUS PAD,INK EJ,VERTICAL	1
K	POROUS PAD,INK EJ,VERTICAL,2	4
L	POROUS PAD,INK EJ,VERTICAL,3	1
M	POROUS PAD,INK EJ,VERTICAL,4	1

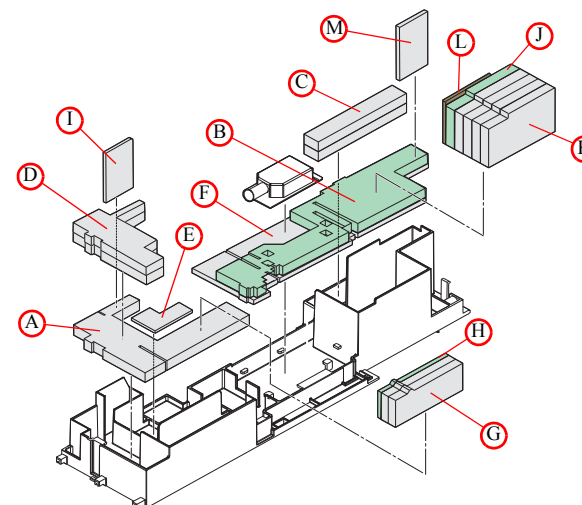


Figure 4-157. Installing the Waste Ink Tray Assy

REASSEMBLY



- Align and insert the ribs (x3) of the Waste Ink Tray Assy to the holes (x3) of the Base Frame, and secure the assy with the hook (x1) and screw (x1). (See Fig. 4-154, Fig. 4-155, Fig. 4-158.)

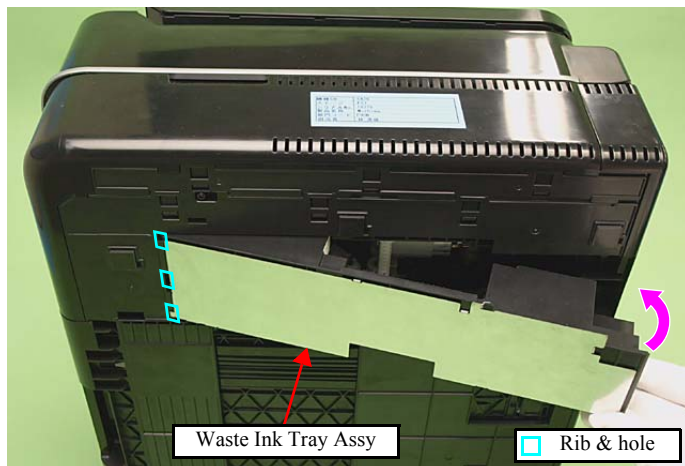


Figure 4-158. Installing the Waste Ink Tray Assy

ADJUSTMENT
REQUIRED

After removing/replacing the Waste Ink Tray Assy, make the specified adjustments. (See Chapter 5 "ADJUSTMENT".)

4.2.4.21 Lower Paper Guide Waste Ink Pad Assy

- Parts/Components need to be removed in advance:
Cassette Unit
- Removal procedure

CAUTION



Be careful about ink spilling if the printer is tilted in practical operation.

1. Release the hooks (x2) and remove the Lower Paper Guide Waste Ink Pad Assy from the opening at the bottom of the Printer.

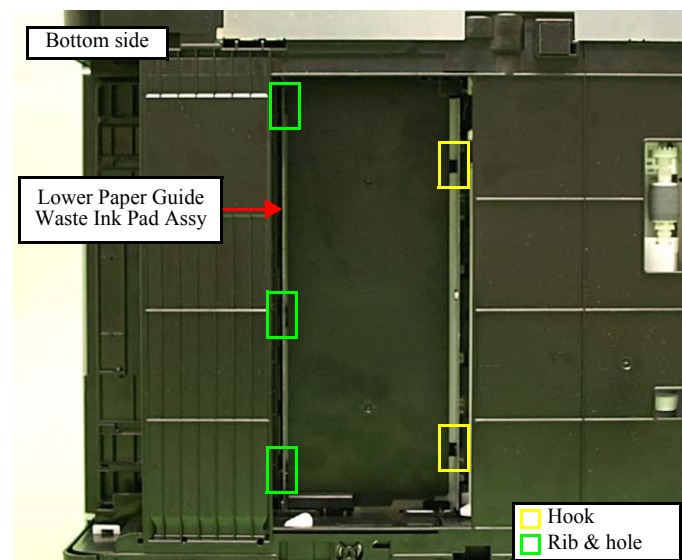


Figure 4-159. Removing the Lower Paper Guide Waste Ink Pad Assy

REASSEMBLY



Align the ribs (x3) of the Lower Paper Guide Waste Ink Pad Assy with the holes (x3) of the Main Frame, and secure the assy with the hooks (x2). (See Fig. 4-159.)

ADJUSTMENT
REQUIRED

After removing/replacing the Lower Paper Guide Waste Ink Pad Assy, make the specified adjustments. (See Chapter 5 "ADJUSTMENT".)

4.2.4.22 Front Paper Guide Waste Ink Pad

- Parts/Components need to be removed in advance:

ADF Unit (Artisan 800/PX800FW/TX800FW only)/Scanner Unit/Upper Left Housing/Paper Guide Top Assy/Upper Housing/Cassette Unit/Lower Paper Guide Waste Ink Pad Assy

- Removal procedure

1. Remove the Front Paper Guide Waste Ink Pad with tweezers.



Figure 4-160. Removing the Front Paper Guide Waste Ink Pad



- Install the Front Paper Guide Waste Ink Pad without any gap. (See Fig. 4-160.)
- Insert the Front Paper Guide Waste Ink Pad till the legs (x8) of Front Paper Guide Waste Ink Pad come out from the Front Paper Guide.

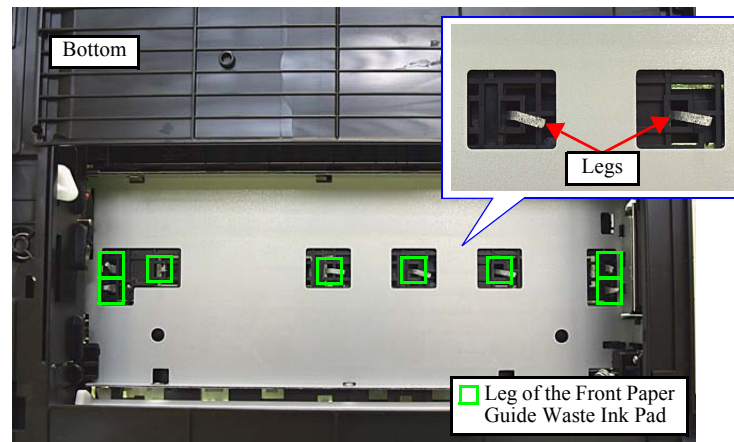


Figure 4-161. Installing the Front Paper Guide Waste Ink Pad

4.2.5 Disassembling Scanner Unit

CHECK POINT



The disassembly/reassembly procedures of Artisan 800/PX800FW/TX800FW differ from those of Artisan 700/PX700W/TX700W. (See 4.1.4 "Additional Procedure/Procedural Differences" (p97).) Unless otherwise specified, this chapter describes Artisan 800/PX800FW/TX800FW. Refer to procedures on the flowchart (Flowchart 4-2 Disassembling Flowchart (2) (p100)) for Artisan 700/PX700W/TX700W.

4.2.5.1 Scanner Upper Housing (Artisan 800/PX800FW/TX800FW)

- Parts/Components need to be removed in advance:
 - Scanner Unit/ADF Unit
- Removal procedure

CAUTION



- It is recommended to remove the Scanner Upper Housing in a clean room or on a clean bench to keep away from dust and dirt.
- Be careful not to damage the document glass on the Scanner Upper Housing.

1. Release the screws (x10) that secure the Scanner Upper Housing, and remove the Scanner Upper Housing.

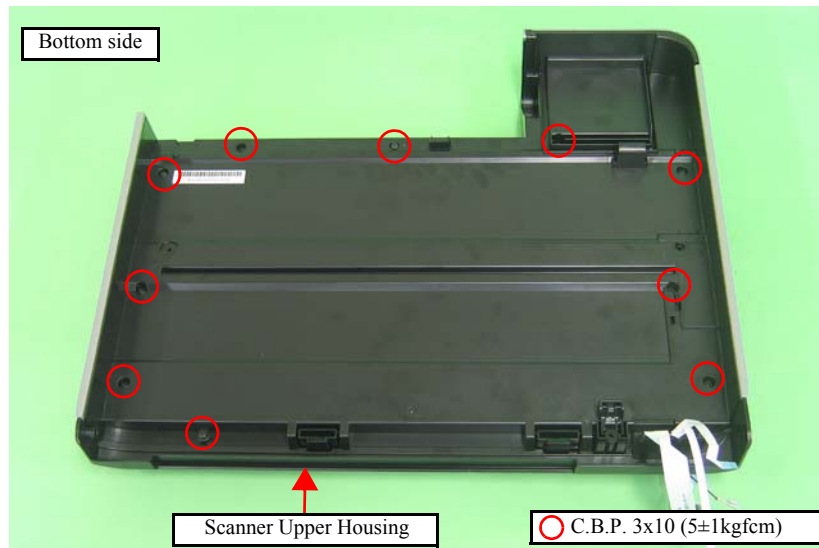


Figure 4-162. Removing the Scanner Upper Housing

REASSEMBLY



- When installing the Upper Scanner Housing, align the rib of the Scanner Upper Housing and the groove of the Scanner Decoration Belt L/R as shown in Fig. 4-163.
- When installing the Scanner Decollation Belt L/R, align the Scanner Lower Housing with the positioning holes and dowels (Left: x3, Right: x5) of the Scanner Decollation Belt as shown below.

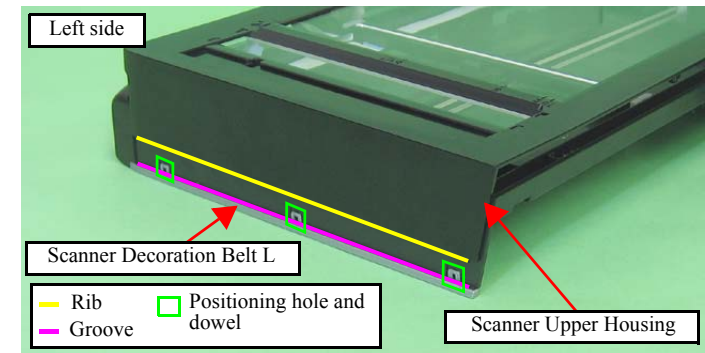
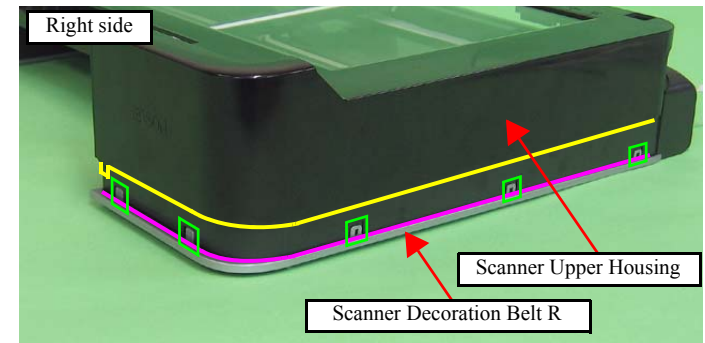


Figure 4-163. Installing the Scanner Upper Housing

4.2.5.2 Scanner Motor Unit

- Parts/Components need to be removed in advance:
Scanner Unit/ADF Unit/Scanner Upper Housing
- Removal procedure



Some of the parts of Artisan 800/PX800FW/TX800FW differ from those of Artisan 700/PX700W/TX700W. Unless otherwise specified, this section describes the procedures for Artisan 800/PX800FW/TX800FW. The differences that may affect the disassembly/reassembly procedures of Artisan 700/PX700W/TX700W will be provided in “Reassembly”, etc.



Be sure of the following.

- Be careful not to touch the Scanner CR Scale with bare hands.
- Be careful not to damage the Scanner CR Scale.

1. Disconnect the Scanner Motor cable from the connector (CN2) on the Scanner CR Encoder Board.
2. Remove the screws (x3) that secure the Scanner Motor Unit and remove the Scanner Motor Unit from the Scanner Lower Housing.

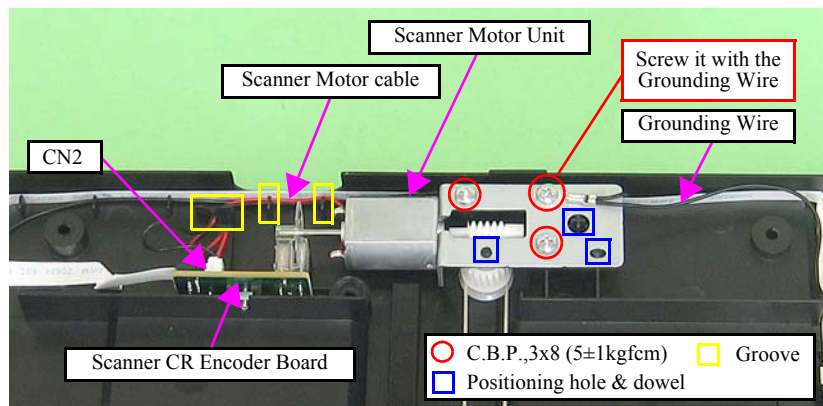


Figure 4-164. Removing the Scanner Motor Unit



When installing the Scanner Motor Unit, be sure of the following.

- Route the Scanner Motor cable through the grooves (x3) of the Scanner Lower Housing. (See Fig. 4-164.)
- Align the positioning holes (x3) of the Scanner Motor Unit with the dowels (x3) of the Scanner Lower Housing. (See Fig. 4-164.)
- Route the Grounding Wire as shown below and in Fig. 4-171. (Artisan 800/PX800FW/TX800FW: Fig. 4-165, Artisan 700/PX700W/TX700W: Fig. 4-166.)

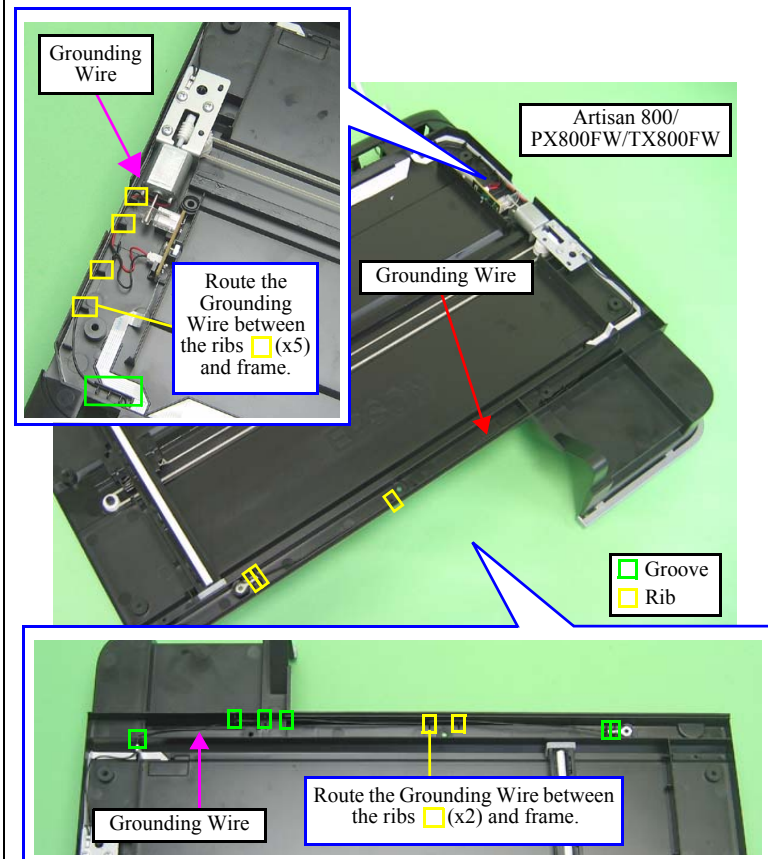


Figure 4-165. Routing the Grounding Wire (Artisan 800/PX800FW/TX800FW)

(Continued to the next page.)

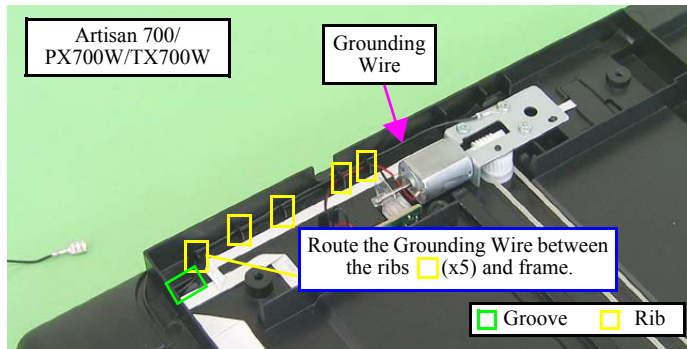


Figure 4-166. Routing the Grounding Wire
(Artisan 700/PX700W/TX700W)

4.2.5.3 Scanner Carriage Unit

- Parts/Components need to be removed in advance:
Scanner Unit/ADF Unit/ Scanner Upper Housing/Scanner Motor Unit
- Removal procedure

CHECK POINT



Some of the parts of Artisan 800/PX800FW/TX800FW differ from those of Artisan 700/PX700W/TX700W. Unless otherwise specified, this section describes the procedures for Artisan 800/PX800FW/TX800FW. The differences that may affect the disassembly/reassembly procedures of Artisan 700/PX700W/TX700W will be provided in “Reassembly”, etc.

CAUTION



Be careful no to damage the Rod Lens Array when removing Scanner Carriage Unit.

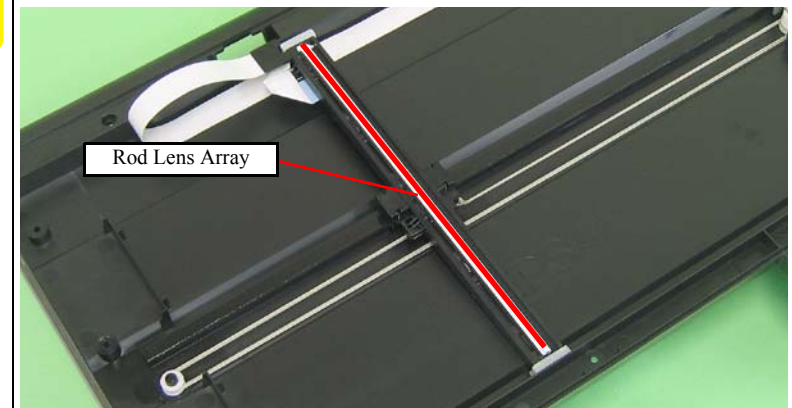


Figure 4-167. Handling the Scanner Carriage Unit

1. Release the ribs (Artisan 800/PX800FW/TX800FW: x4, Artisan 700/PX700W/TX700W: x3) that secure the Scanner Cable Cover to the Scanner Lower Housing, and remove the Scanner Cable Cover from the Scanner Lower Housing in the direction of the arrow.
2. Pull out the Ferrite Core from the Scanner Carriage FFC.

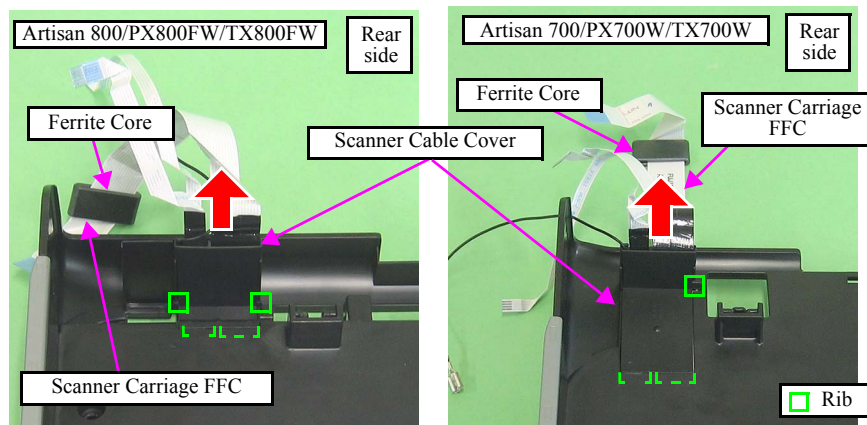


Figure 4-168. Removing the Carriage Unit (1)

3. Turn the Combination Gear 12.1, 11.3 in the direction of the arrow, and move the Scanner Carriage Unit to the center.



Take extra care not to contaminate the Scanner Timing Belt with grease on the rail of the Lower Scanner Housing.

4. Remove the Driven Pulley and Combination Gear 12.1, 11.3 from the Scanner Lower Housing, and remove the Scanner Timing Belt.

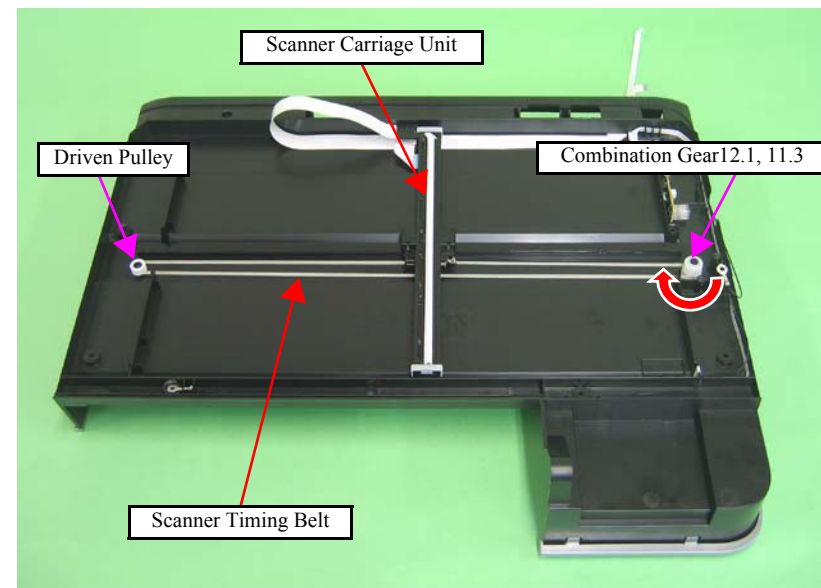


Figure 4-169. Removing the Scanner Carriage Unit (2)



Be careful not to damage the Scanner Carriage FFC since they are secured with double-sided tape (x2).



After replacing or removing the Scanner Carriage, be sure to perform the required lubrication. (See Chapter 6 "MAINTENANCE".)

5. Peel off the Scanner Carriage FFC from the Scanner Lower Housing, and remove the Scanner Carriage Unit.

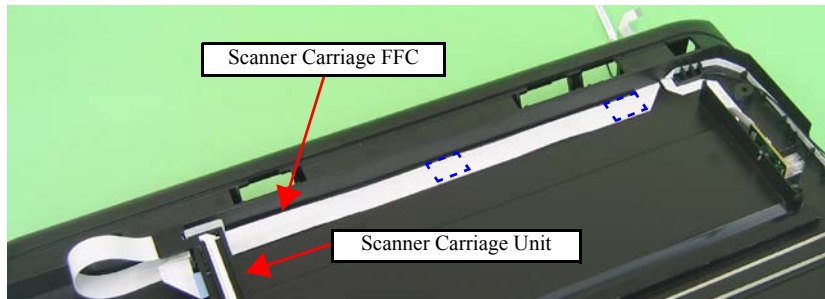


Figure 4-170. Removing the Carriage Unit (3)



When attaching the Scanner Cable Cover, route the FFC and Grounding Wire as shown below.

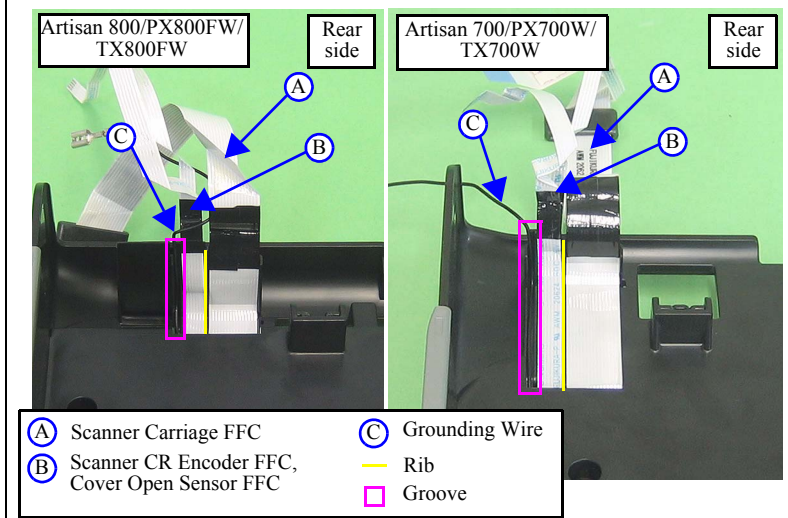


Figure 4-171. Attaching the Scanner Cable Cover

4.2.5.4 Scanner CR Encoder Board

- Parts/Components need to be removed in advance:
Scanner Unit/ADF Unit/Scanner Upper Housing
- Removal procedure
 1. Disconnect the Scanner Motor cable from the connector on the Scanner CR Encoder Board. (See [4.2.5.2 Scanner Motor Unit Step1 \(p168\)](#).)
 2. Disconnect the Scanner CR Encoder FFC from the connector (CN1) on the Scanner CR Encoder Board.
 3. Loosen the screw that secures the Scanner CR Encoder Board to the Scanner Lower Housing, and remove Scanner CR Encoder Board from the Scanner Lower Housing.

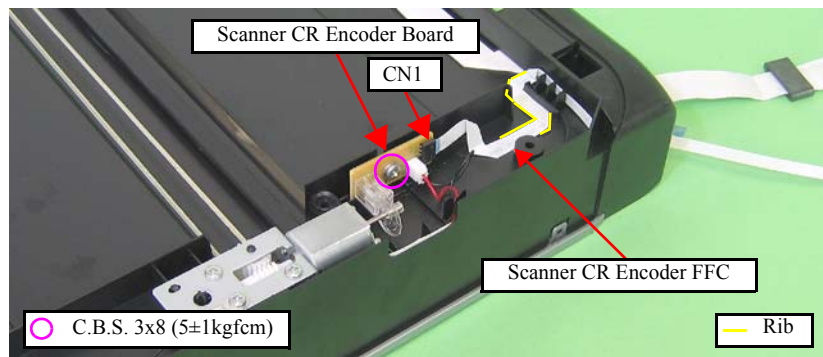


Figure 4-172. Removing the Scanner CR Encoder Board

REASSEMBLY



When routing the Scanner CR Encoder FFC of Artisan 800/PX800FW/TX800FW, route it as shown in [Fig. 4-168](#) and [Fig. 4-172](#). See [Fig. 4-171](#) and below for Artisan 700/PX700W/TX700W.

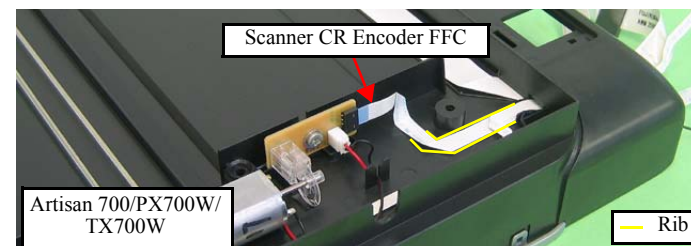


Figure 4-173. Routing the FFC
(Artisan 700/PX700W/TX700W)

4.2.5.5 Cover Open Sensor

- Parts/Components need to be removed in advance:
Scanner Unit/ADF Unit/Scanner Upper Housing
- Removal procedure

CHECK POINT



Some of the parts of Artisan 800/PX800FW/TX800FW differ from those of Artisan 700/PX700W/TX700W. Unless otherwise specified, this section describes the procedures for Artisan 800/PX800FW/TX800FW. The differences that may affect the disassembly/reassembly procedures of Artisan 700/PX700W/TX700W will be provided in “Reassembly”, etc.

1. Release the hooks (x2) of the Sensor Cover, and remove the Sensor Cover from the Scanner Lower Housing.

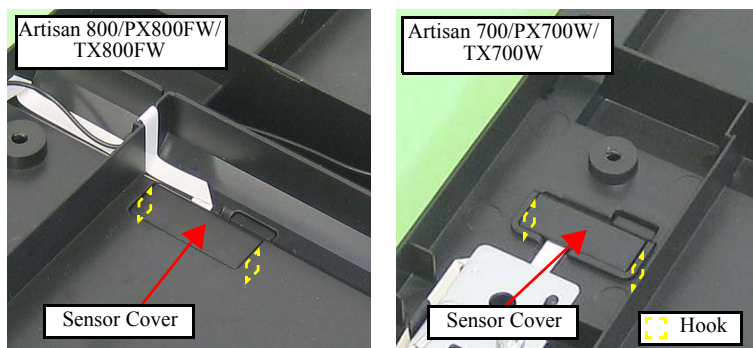


Figure 4-174. Removing the Cover Open Sensor (1)

2. Disconnect the Cover Open Sensor FFC from the connector of the Cover Open Sensor, and remove the Cover Open Sensor from the Scanner Lower Housing.

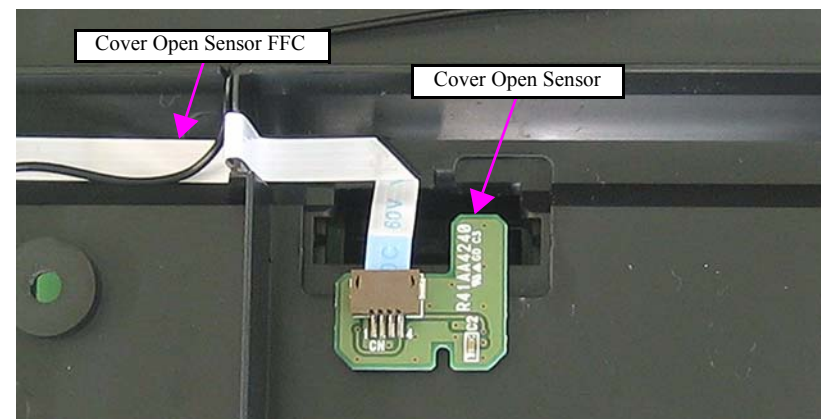


Figure 4-175. Removing the Cover Open Sensor (2)



- When attaching the Cover Open Sensor, insert it into the space inside the ribs (x2) □ of the Scanner Lower Housing as shown in Fig. 4-174.

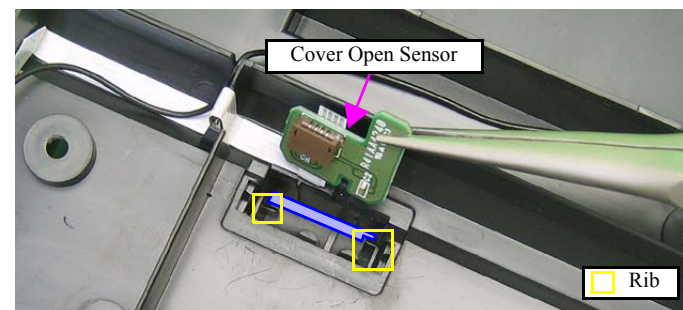


Figure 4-176. Attaching the Cover Open Sensor

REASSEMBLY



- When routing the Cover Open Sensor FFC, route it as shown below and in Fig. 4-171.

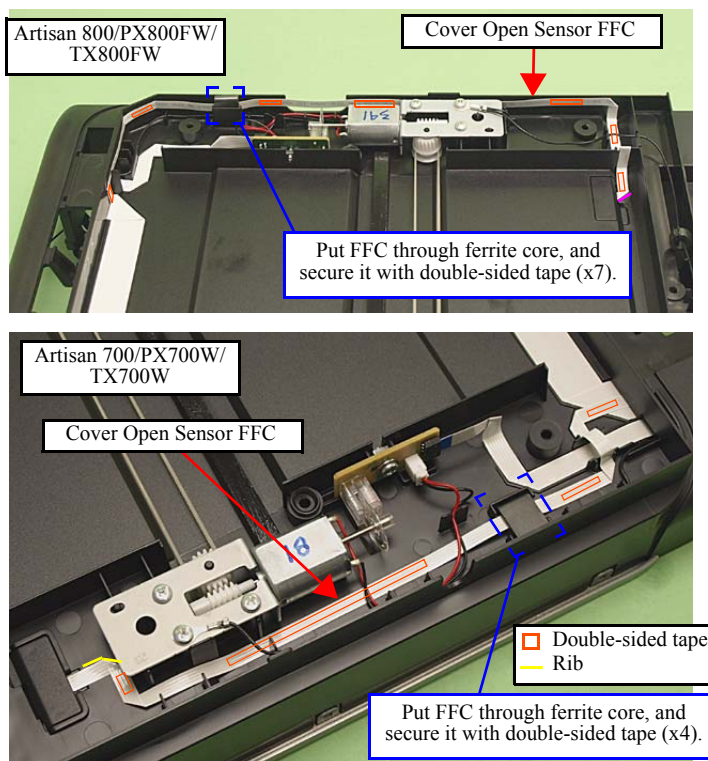


Figure 4-177. Routing the Cover Open Sensor FFC

4.2.6 Disassembly of the ADF Unit (Artisan 800/PX800FW/TX800FW only)

4.2.6.1 ADF Hinge

- Parts/Components need to be removed in advance:
 - Scanner Unit/ADF Unit
- Removal procedure
 1. Release the guide pins (2 each) that secure the ADF Hinges, and remove the ADF Hinges from the ADF Base Assy.

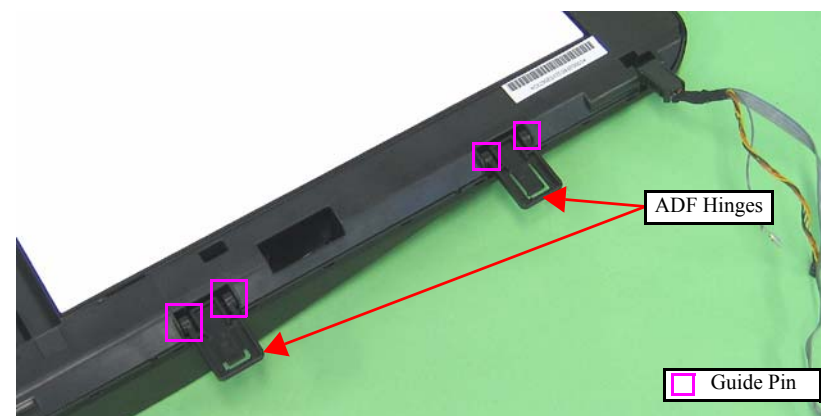


Figure 4-178. Removing the ADF Hinge

4.2.6.2 ADF Cover Assy/ADF Cover L

- Parts/Components need to be removed in advance:

Scanner Unit/ADF Unit

- Removal procedure

1. Open the ADF Cover Assy.
2. Release the guide pins (x2) that secure the ADF Cover Assy, and remove the ADF Cover Assy.

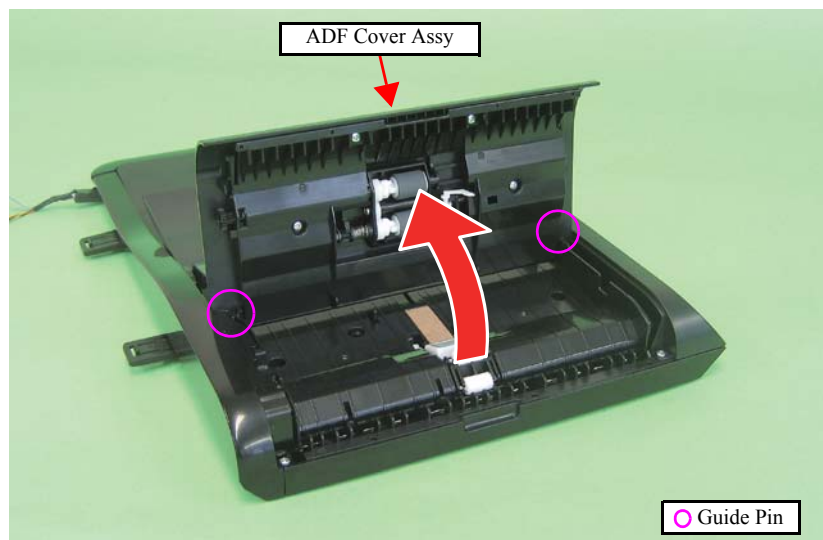


Figure 4-179. Removing the ADF Cover Assy

3. Release the hooks (x2) and the dowel (x1) that secure the ADF Cover L, and remove the ADF Cover L.

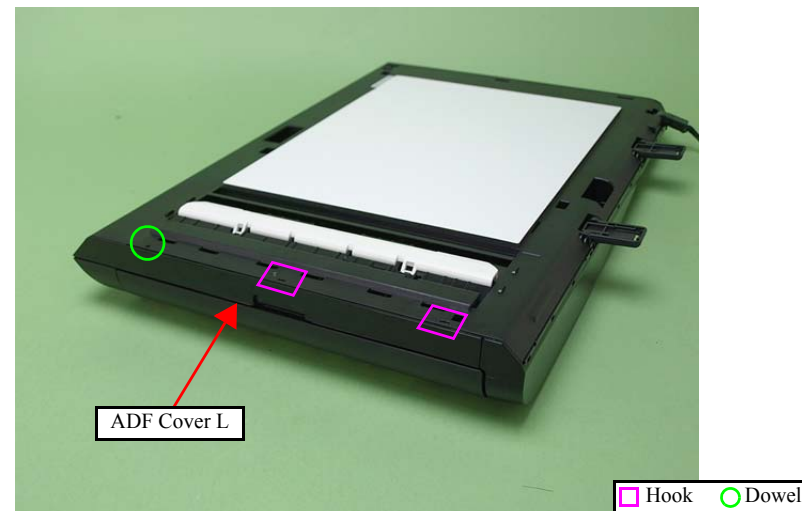


Figure 4-180. Removing the ADF Cover L



When installing the ADF Cover L, align the ribs (x5) of the ADF Cover L with the grooves (x5) of the ADF Base Assy.

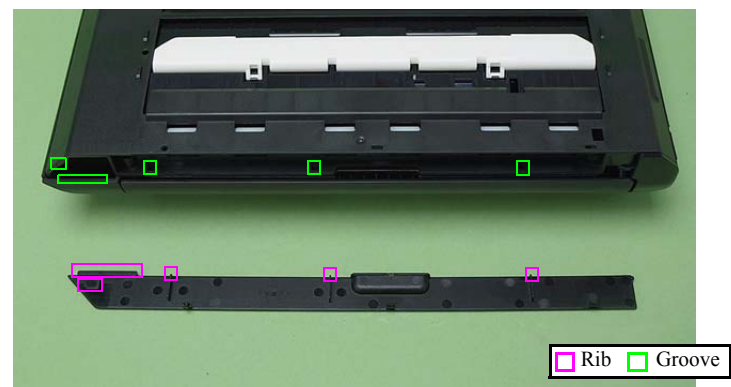


Figure 4-181. Installing the ADF Cover L

4.2.6.3 ADF LD Frame Assy

- Parts/Components need to be removed in advance:
Scanner Unit/ADF Unit/ADF Cover Assy
- Removal procedure
 1. Remove the screws (x4) that secure the ADF LD Frame Assy, and remove the ADF LD Frame Assy from the ADF Cover Assy.

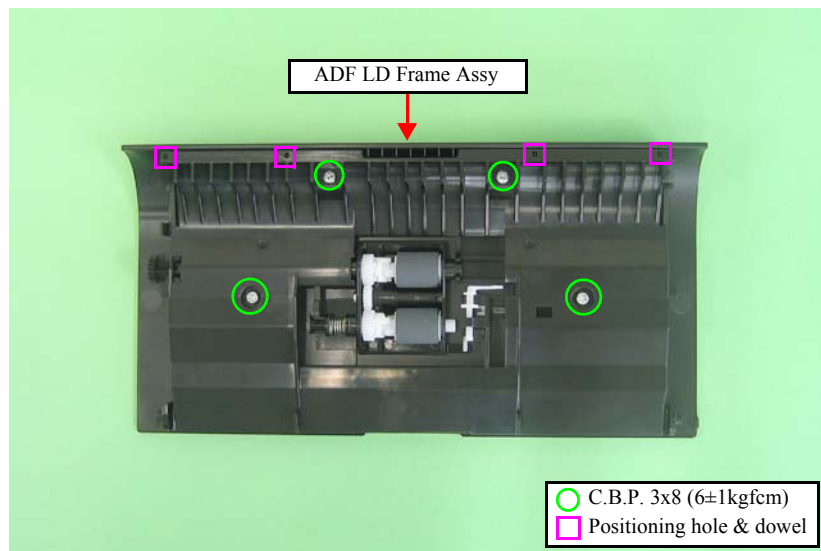


Figure 4-182. Removing the ADF LD Frame Assy



When installing the ADF LD Frame Assy, align the dowels(x4) of the ADF Cover Assy with the positioning holes (x4) of the ADF LD Frame Assy as shown in Fig. 4-182.

4.2.6.4 ADF Right Cover/ADF Rear Cover

- Parts/Components need to be removed in advance:
Scanner Unit/ADF Unit/ADF Cover Assy
- Removal procedure
 1. Release the hooks (x3) that secure the ADF Right Cover, and remove the ADF Right Cover from the ADF Base Assy.

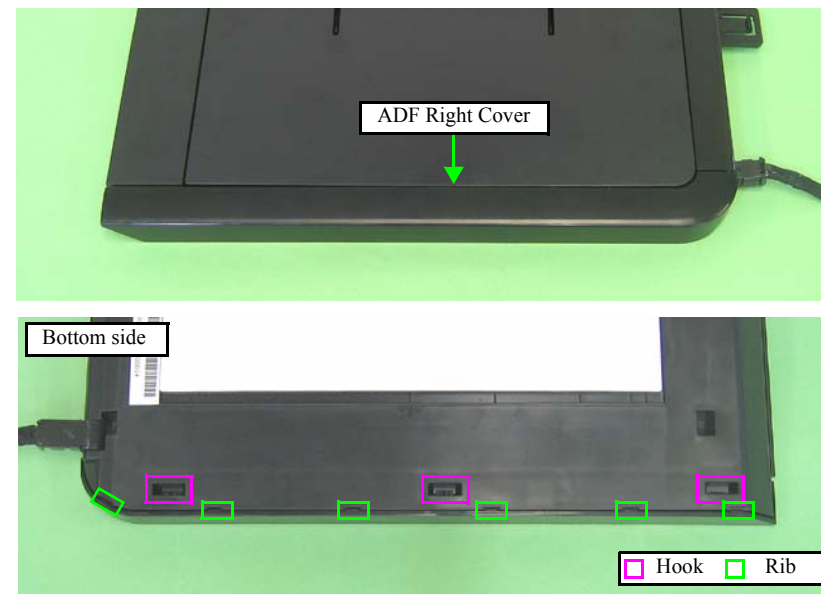


Figure 4-183. Removing the ADF Right Cover

2. Open the ADF Document Support Cover.
3. Remove the screws (x3) that secure the ADF Rear Cover.
4. Release the hooks (x11) that secure the ADF Rear Cover, and remove the ADF Rear Cover from the ADF Base Assy.

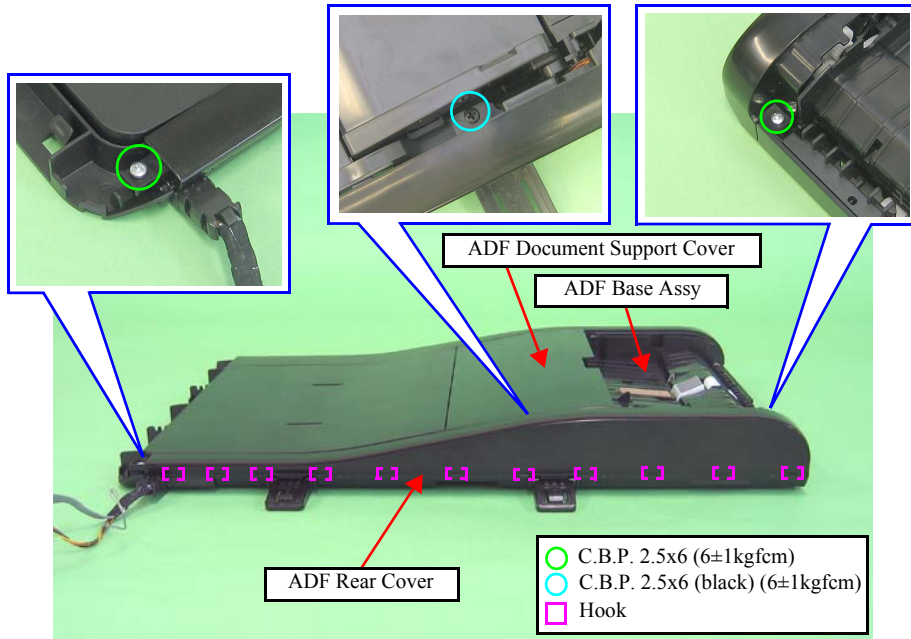


Figure 4-184. Removing the ADF Rear Cover



- When installing the ADF Right Cover, align the positioning holes (x2) with the dowels (x2) of the ADF Right Cover and the ADF Base Assy, and also align the ribs (x6) shown in Fig. 4-183.

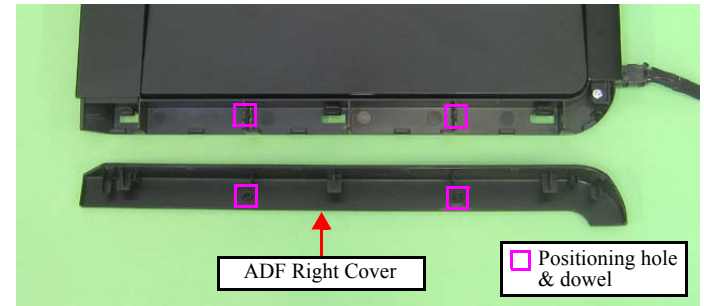


Figure 4-185. Installing the ADF Right Cover

- When installing the ADF Rear Cover, align the ribs with the grooves (x3) as shown below.

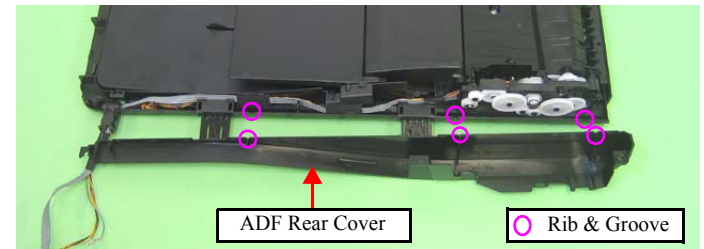


Figure 4-186. Installing the ADF Rear Cover

4.2.6.5 ADF Cover Stacker/ADF Document Support Cover

- Parts/Components need to be removed in advance:

Scanner Unit/ADF Unit/ADF Cover Assy/ADF Right Cover/ADF Rear Cover

- Removal procedure

1. Release the dowels (x2) that secure the ADF Cover Stacker, and remove the ADF Cover Stacker from the ADF Base Assy.

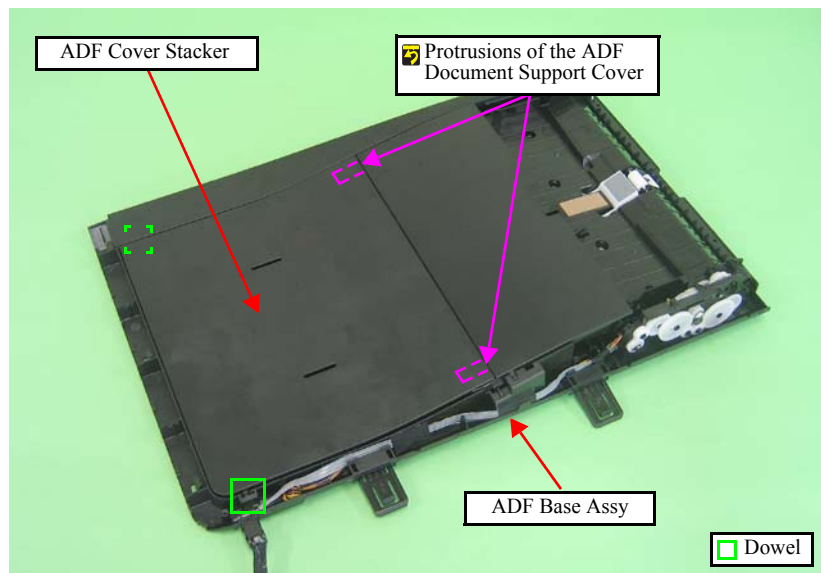


Figure 4-187. Removing the ADF Cover Stacker

2. Release the dowels (x2) that secure the ADF Document Support Cover, and remove the ADF Document Support Cover from the ADF Base Assy.

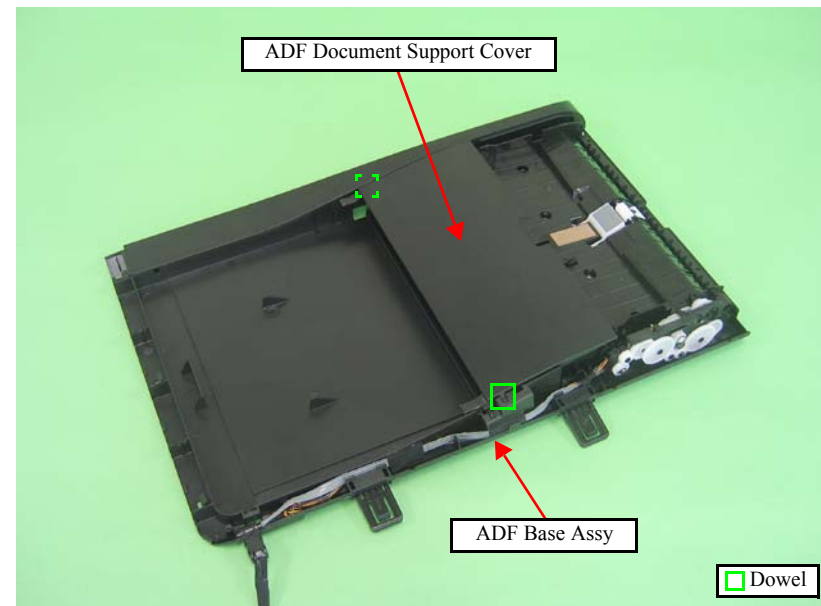


Figure 4-188. Removing the ADF Document Support Cover



When installing the ADF Cover Stacker, insert the protrusions (x2) of the ADF Document Support Cover under the ADF Cover Stacker as shown in [Fig. 4-187](#).

4.2.6.6 ADF Front Cover

- Parts/Components need to be removed in advance:
Scanner Unit/ADF Unit/ADF Cover Assy/ADF Right Cover A/DF Rear Cover/
ADF Cover Stacker/ADF Document Support Cover
- Removal procedure
 1. Remove the screws (x2) that secure the ADF Front Cover.

CAUTION


When removing the ADF Front Cover, be careful not to damage the positioning holes (x4) of the ADF Front Cover shown in Fig. 4-189.

2. Release the ribs (x4) of the ADF Base Assy from the ADF Front Cover and remove the ADF Front Cover from the ADF Base Assy.

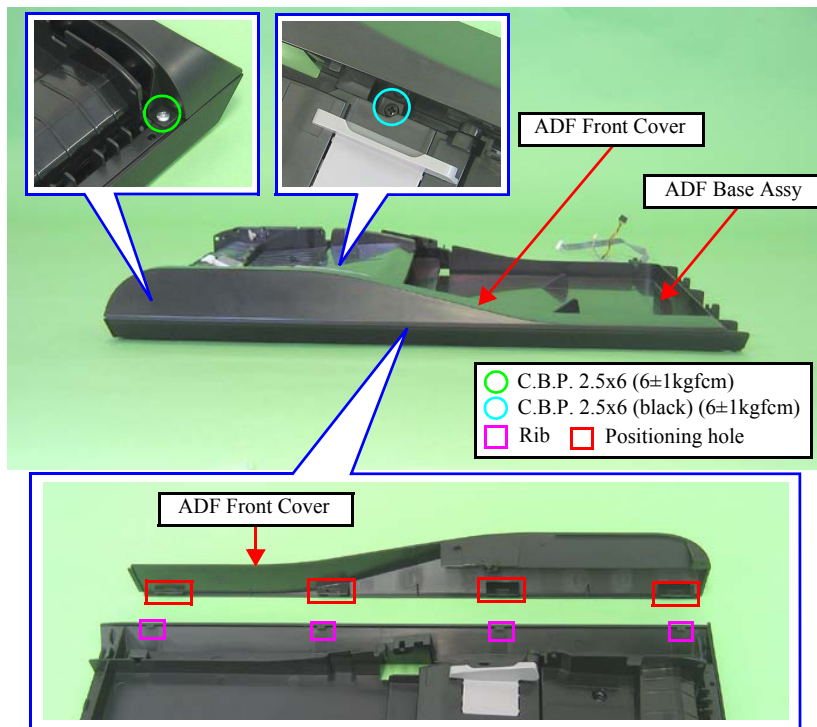


Figure 4-189. Removing the ADF Front Cover

4.2.6.7 ADF Document Support Assy

- Parts/Components need to be removed in advance:
Scanner Unit/ADF Unit/ADF Cover Assy/ADF Right Cover/ADF Rear Cover/
ADF Cover Stacker/ADF Document Support Cover/ADF Front Cover
- Removal procedure
 1. Release the hooks (x2) that secure the ADF Document Support Assy.
 2. Release the dowels (x2) that secure the ADF Document Support Assy, and remove the ADF Document Support Assy from the ADF Base Assy.

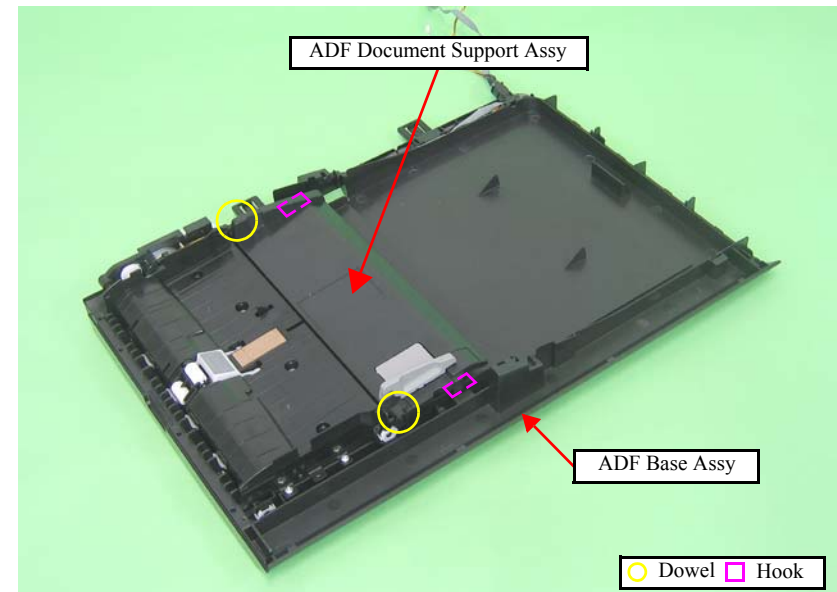


Figure 4-190. Removing the ADF Document Support Assy

4.2.6.8 ADF Frame Unit

- Parts/Components need to be removed in advance:

Scanner Unit/ADF Unit/ADF Cover Assy/ADF Right Cover/ADF Rear Cover/
ADF Cover Stacker/ADF Document Support Cover/ADF Front Cover/ADF
Document Support Assy

- Removal procedure

1. Peel off the acetate tape (x2), and release the cable of the ADF Unit from the ADF Base Assy.

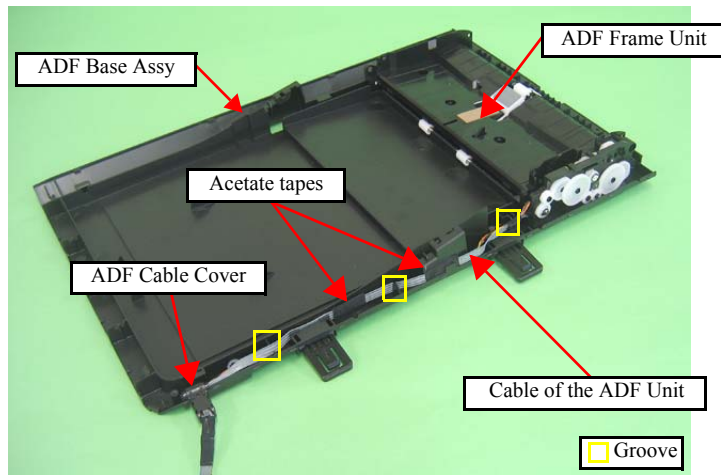


Figure 4-191. Removing the ADF Frame Unit (1)

2. Remove the screws (x2) that secure the ADF Frame Unit.
3. Release the dowel □ (x1) of the ADF Base and the dowels □ (x2) of the ADF Frame Unit, then remove the ADF Frame Unit from the ADF Base Assy.

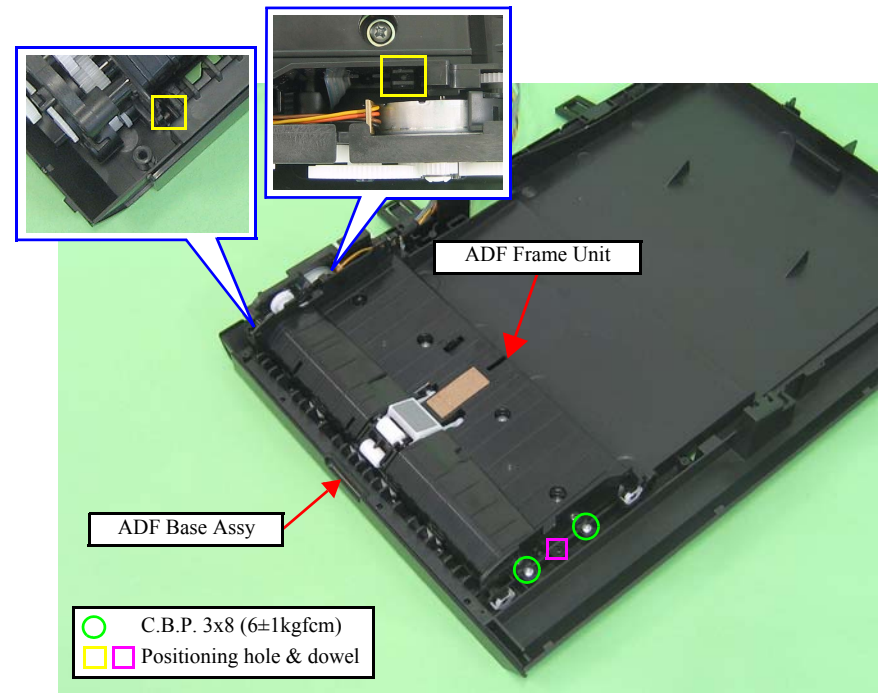


Figure 4-192. Removing the ADF Frame Unit (2)



- When installing the ADF Frame Unit, align the positioning holes (x3) of the ADF Frame Unit and ADF Base Assy with the dowels (x3) □ □ as shown in Fig. 4-192.
- Route the ADF Motor cable, ADF Sensor cable, and the Grounding Wire as follows, referring to Fig. 4-191.
 1. Route them through the grooves (x3) of the ADF Base Assy.
 2. Attach the ADF Cable Cover to the ADF Base Assy.
 3. Secure the cables to the ADF Base Assy with acetate tape (x2).

4.2.6.9 ADF Motor Unit

- Parts/Components need to be removed in advance:

Scanner Unit/ADF Unit/ADF Cover Assy/ADF Right Cover/ADF Rear Cover/
ADF Cover Stacker/ADF Document Support Cover/ADF Front Cover/ADF
Document Support Assy/ADF Frame Unit

- Removal procedure

1. Peel off the acetate tape (x3), and separate the ADF Motor cable, the ADF Sensor cable and the Grounding Wire.
2. Release the hooks (x4) of the ADF Cable Cover and open the ADF Cable Cover, then release the ADF Motor cable, the ADF Sensor cable and the Grounding Wire.

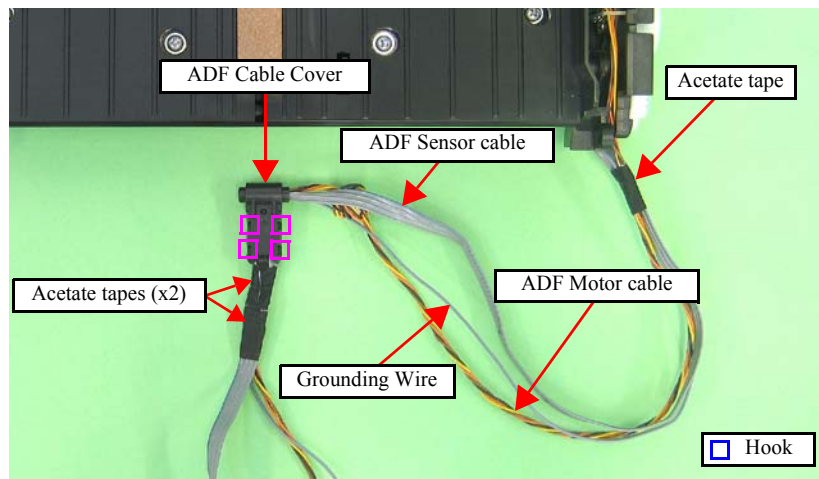


Figure 4-193. Releasing the cables



When removing the ADF Motor Unit, be careful not to drop the gears (x5) of the ADF Frame Unit and ADF Motor Unit shown below.

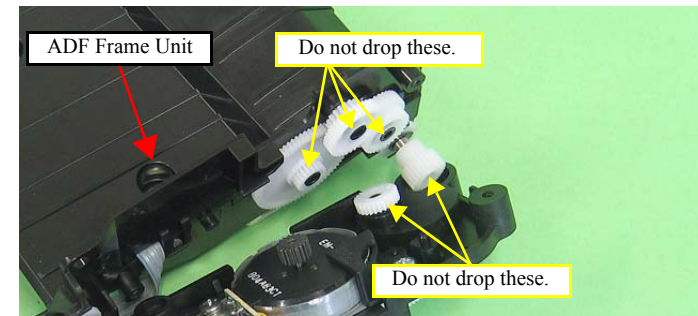


Figure 4-194. Handling the ADF Motor Unit

3. Remove the screws (x2) that secure the ADF Motor Unit.

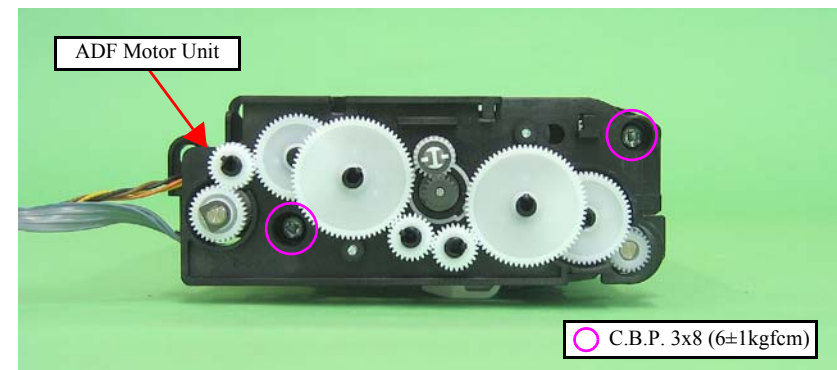


Figure 4-195. Removing the ADF Motor Unit (1)

4. Remove the screw (x1), and remove the torsion spring and the Grounding Wire from the ADF Motor Unit, then remove the ADF Motor Unit from the ADF Frame Unit.

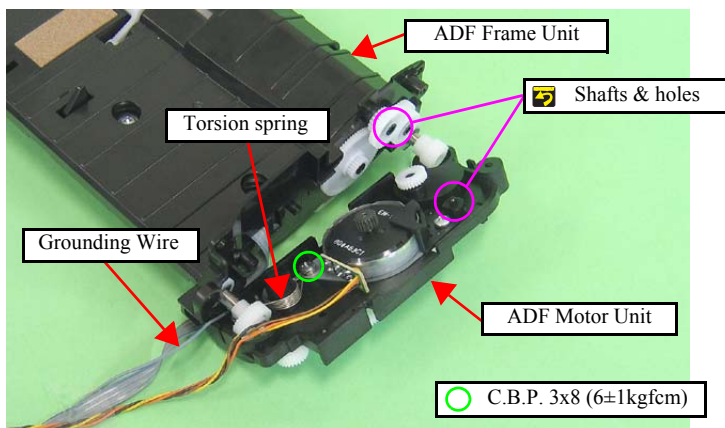


Figure 4-196. Removing the ADF Motor Unit (2)



Be careful of the following when installing the ADF Motor Unit.

- Route the ADF Motor cable, the ADF Sensor cable and the Grounding Wire as shown below.

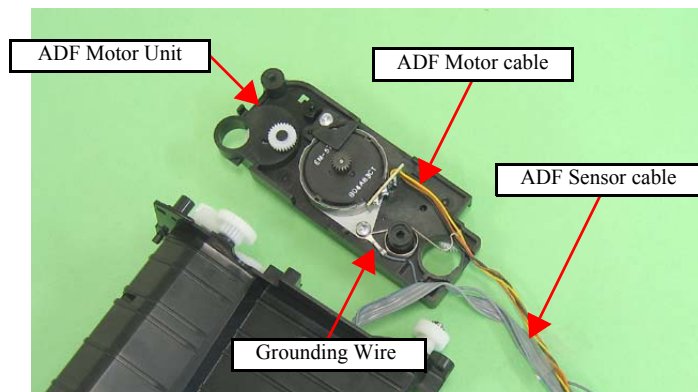


Figure 4-197. Routing the cables

- Attach the torsion spring from under the ADF EJ Roller.

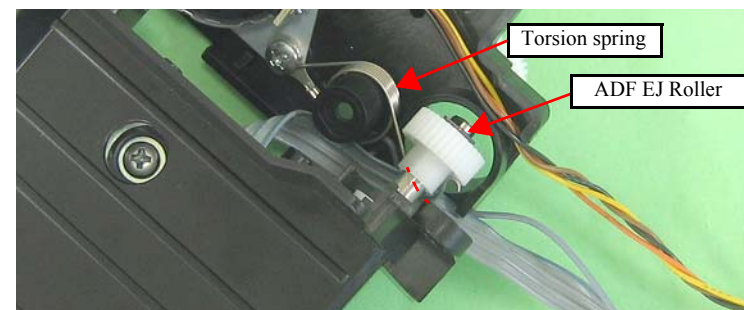


Figure 4-198. Attaching the torsion spring

- Insert the shaft of the ADF Motor Unit to the hole of the ADF Frame Unit as shown in Fig. 4-196.

REASSEMBLY

- When placing the cables on the ADF Cable Cover, route them as shown below.

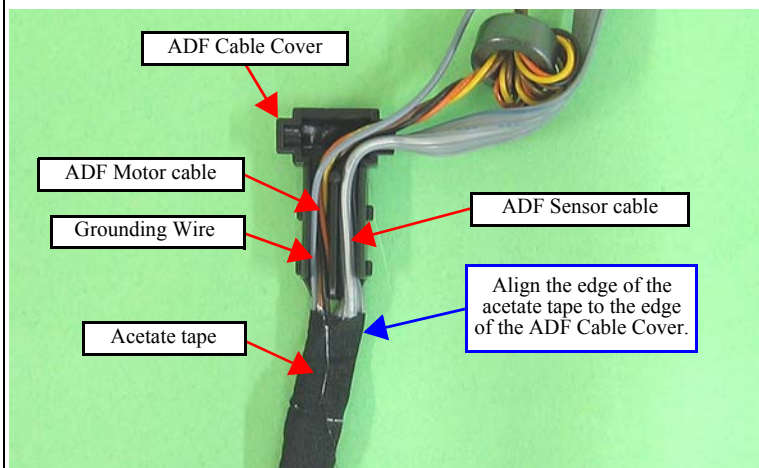


Figure 4-199. Routing the cables in the ADF Cable Cover

4.2.6.10 ADF PF Roller

- Parts/Components need to be removed in advance:

Scanner Unit/ADF Unit/ADF Cover Assy/ADF Right Cover/ADF Rear Cover/ADF Cover Stacker/ADF Document Support Cover/ADF Front Cover/ADF Document Support Assy/ADF Frame Unit

- Removal procedure

1. Remove the Spur Gear 6.4, securing ring and the ADF EJ Rear Bush from the ADF PF Roller.

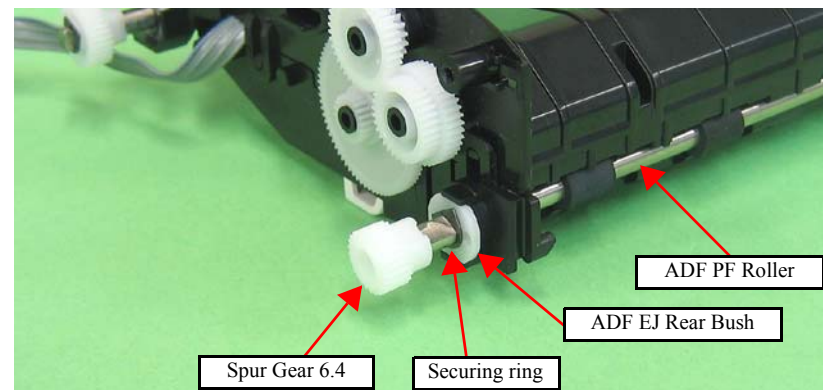


Figure 4-200. Removing the ADF PF Roller (1)

2. Release the hooks (x2) and remove the ADF EJ Front Bush from the ADF Frame Unit.

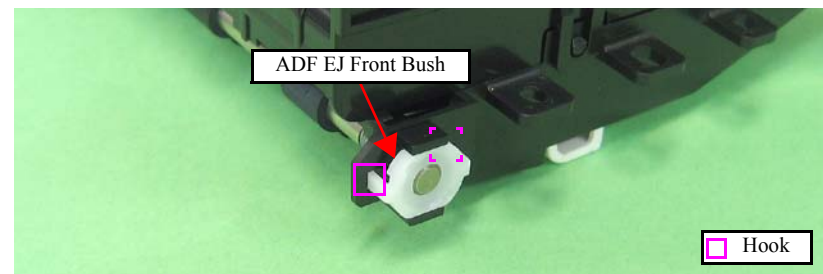


Figure 4-201. Removing the ADF PF Roller (2)

3. Remove the E-ring.
4. Remove the torsion spring from the ADF PF Roller, and remove the ADF PF Roller from the ADF Frame Unit in the direction of the arrow.

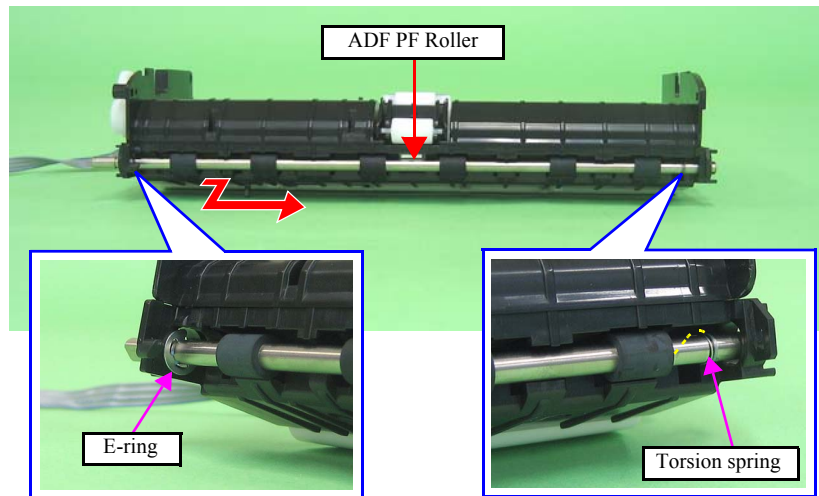


Figure 4-202. Removing the ADF PF Roller (3)



When installing the ADF PF Roller, attach the leg of the torsion spring on the ADF PF Roller as shown in [Fig. 4-202](#).



After replacing or removing the ADF PF Roller, be sure to perform the required lubrication. (See [Chapter 6 "MAINTENANCE"](#).)

4.3 Disassembly/reassembly procedures specific to Artisan 700/PX700W/TX700W

4.3.1 Removing the Housing

4.3.1.1 Scanner Unit (Artisan 700/PX700W/TX700W)

CHECK POINT


The disassembly/reassembly procedures for Artisan 800/PX800FW/TX800FW differ from those of Artisan 700/PX700W/TX700W, see 4.2.2.2 "Scanner Unit" (p103) for the procedures.

- Parts/Components need to be removed in advance:
None
- Removal procedure
 1. Open the Scanner Unit.

CHECK POINT


The harness cover clamp needs to be cut when removing and cannot be reused. When installing the Cable Cover, replace it with a new one. (See Fig. 4-2)

2. Cut the harness cover clamp with a nipper as shown in Fig. 4-203, and remove the Cable Cover.
3. Slide the Cable Cover to the rear of the printer by pushing the point A of the Cable Cover to release the hooks (x4) and ribs (x2), and remove the Cable Cover.

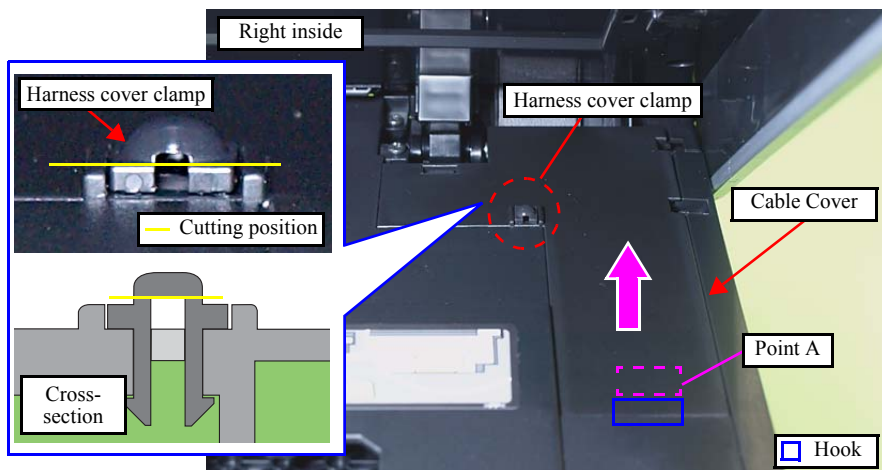


Figure 4-203. Removing the Cable Cover

4. Peel off the Scanner FFC (x3) together with the Ferrite core (x1) from the Main Board.
5. Pull out the terminal of the Grounding Wire from the Frame.

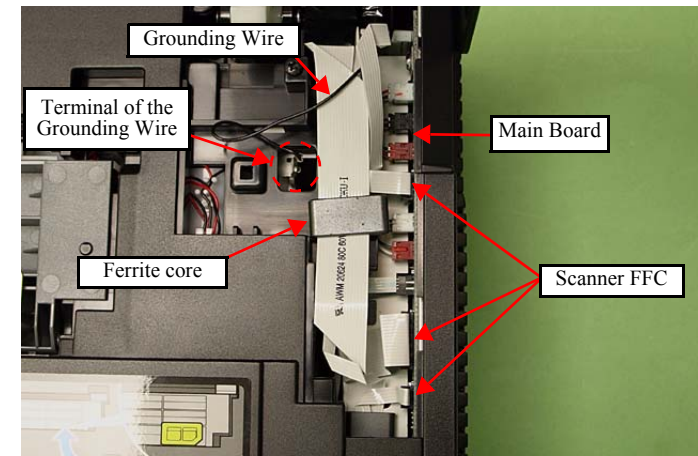


Figure 4-204. Removing the Scanner Unit (1)

CAUTION


Do not open/close the Scanner Unit with the screws that secure the unit removed to avoid damage of the Scanner Unit Hinge.

6. Remove the screw (x1) that secures the Scanner Unit.

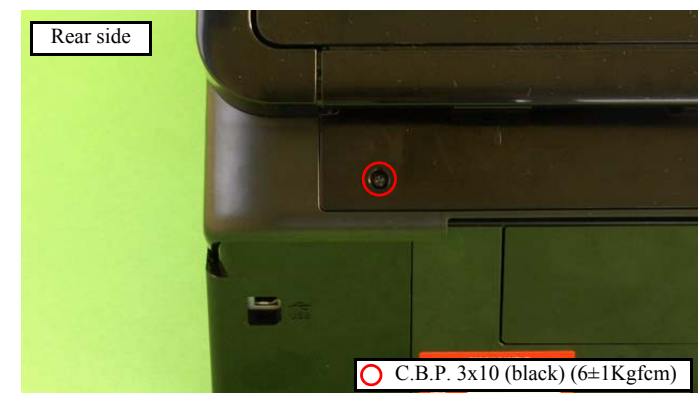


Figure 4-205. Removing the Scanner Unit (2)

7. Lift the Hinge on the right side in the direction of the arrow (1), and slide the Scanner Unit in the direction of the arrow (2), and remove it.



Figure 4-206. Removing the Scanner Unit (3)



- When installing the Scanner Unit, follow the procedure below.
1. Align and insert the dowel of the Scanner Unit to the positioning hole of the printer (Left inside).
 2. Align and insert the rib of the Scanner Unit to the groove of the Hinge.

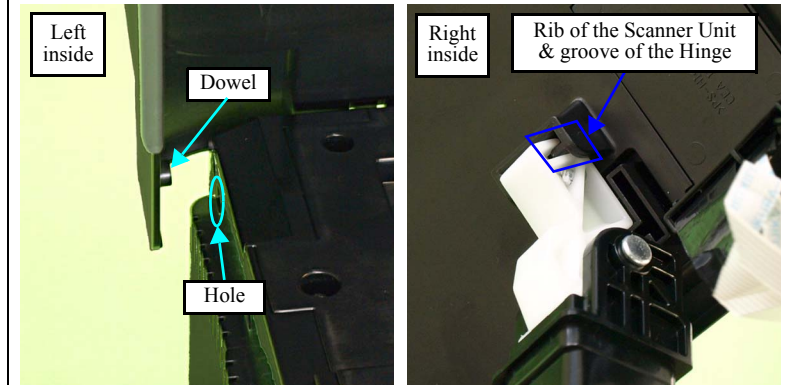


Figure 4-207. Installing the Scanner Unit (1)

3. While aligning and inserting the rib of the Scanner Unit to the groove of the Hinge, secure them with the screw (x1) temporarily with the screw holes aligned as shown in Fig. 4-205. It is recommended to prepare a pillow-shaped supporter to keep this position. (See Fig. 4-10.)

(Continued to the next page.)

REASSEMBLY



4. Close the Scanner Unit while temporarily tightening them screw (x1).
5. Tighten the screw (x1) after making sure that there is no gap between the Scanner Unit and the printer.

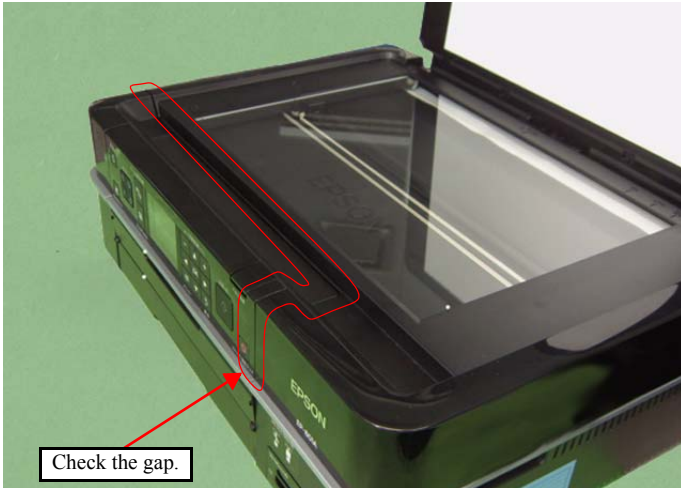


Figure 4-208. Installing the Scanner Unit (2)

- Make sure to insert the terminal of the Grounding wire to the fixing rib of the frame. (See Fig. 4-204.)
- For the routing the FFCs, see 4.4 "Routing FFC/cables" (p202).
- When installing the Cable Cover, secure it with a new Harness Cover Clamp. (See Fig. 4-203.)

ADJUSTMENT
REQUIRED

After removing/replacing the Scanner Unit, make the specified adjustments. (See Chapter 5 "ADJUSTMENT".)

4.3.1.2 Upper Left Housing (Artisan 700/PX700W/TX700W)

CHECK
POINT

The disassembly/reassembly procedures for Artisan 800/PX800FW/TX800FW differ from those of Artisan 700/PX700W/TX700W, see 4.2.2.4 "Upper Left Housing / Panel Lock Button" (p106) for the procedures.

- Parts/Components need to be removed in advance:
 - None
- Removal procedure
 1. Remove the screw (x1) that secures the Upper Left Housing.
 2. Slide the Upper Left Housing to the rear side, release the hooks (x2) and remove the Upper Left Housing.

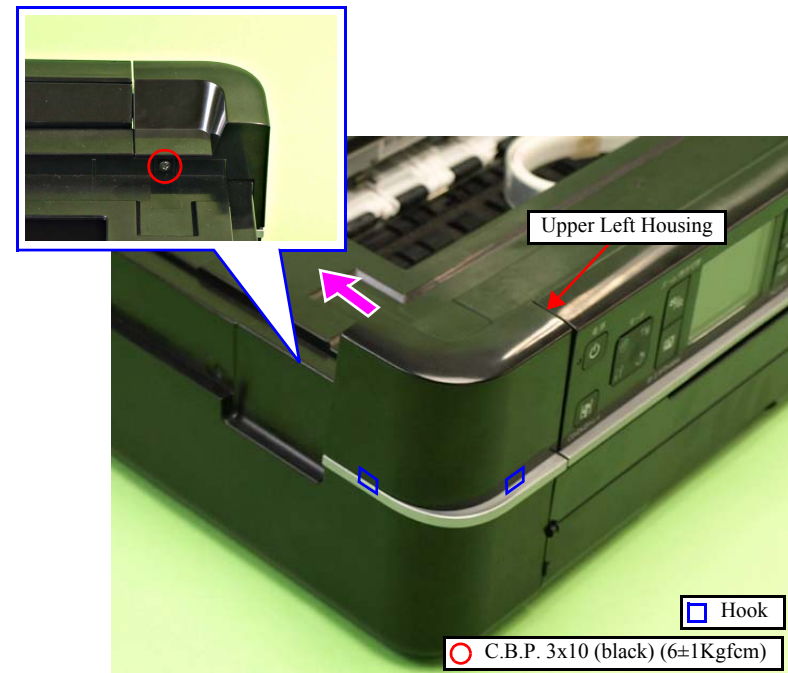


Figure 4-209. Removing the Upper Left Housing

4.3.1.3 Upper Housing (Artisan 700/PX700W/TX700W)

CHECK POINT


The disassembly/reassembly procedures for Artisan 800/PX800FW/TX800FW differ from those of Artisan 700/PX700W/TX700W, see 4.2.2.5 "Upper Housing" (p107) for the procedures.

- Parts/Components need to be removed in advance:
Scanner Unit/Upper Left Housing/Paper Guide Top Assy
- Removal procedure

CAUTION


The Grounding Wire is attached to the frame with a screw. Be careful not to deform the frame when removing the screw.

1. Remove the screw (x1) and release the Grounding Wire.

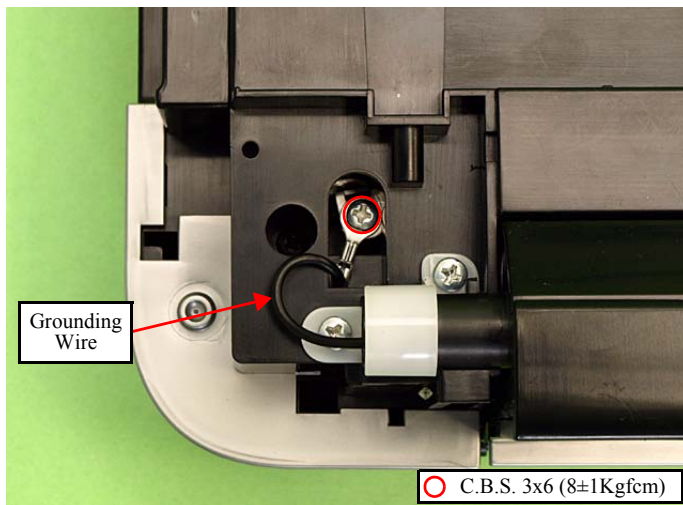


Figure 4-210. Releasing the Grounding Wire

2. Release the hooks (x5) of the Panel Unit Front Cover. (See Fig. 4-211)
3. While pushing the Panel Lock Button, slide the Panel Upper Cover in the direction of the arrow to release the hook (x8) of the Panel Upper Cover, and remove the Panel Upper Cover.

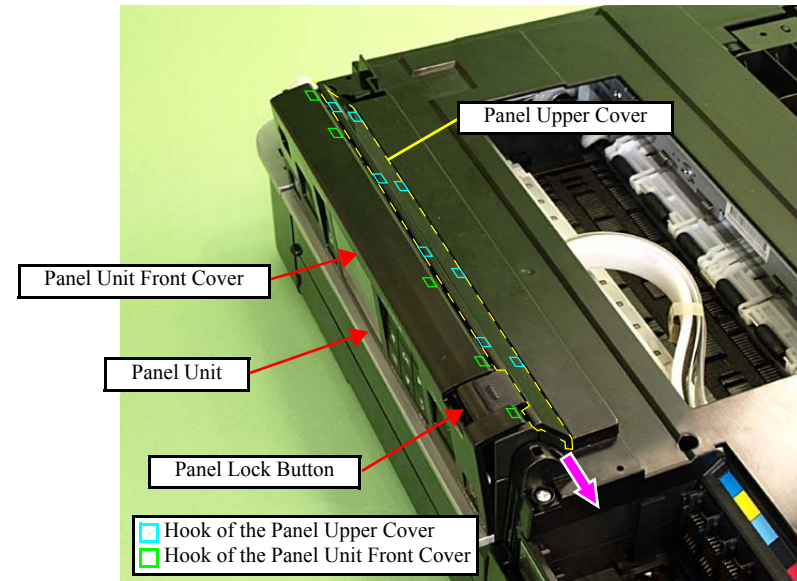


Figure 4-211. Removing the Upper Housing (1)

4. Remove the screws (x10) that secure the Upper Housing.

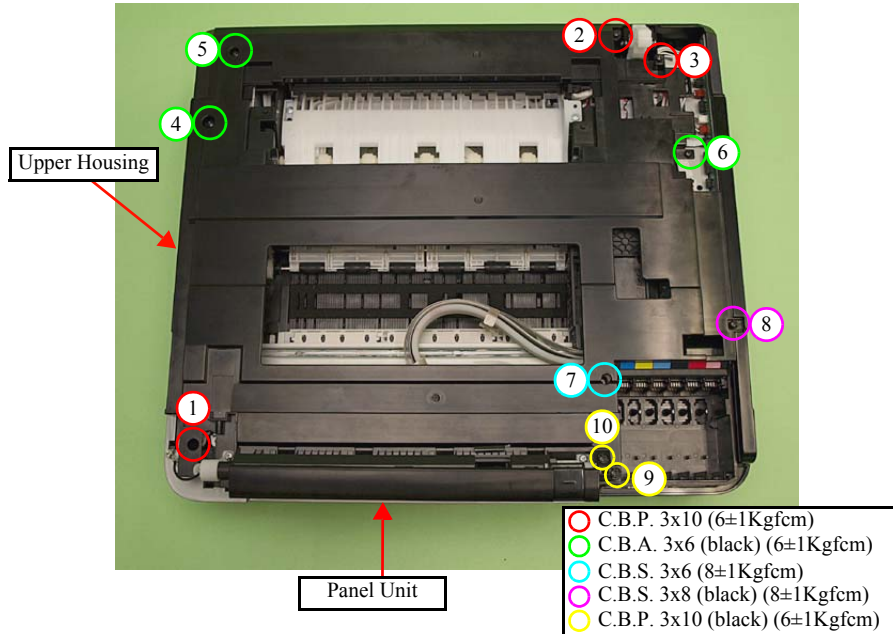


Figure 4-212. Removing the Upper Housing (2)

5. Open the Panel Unit, and lift the Panel Unit until the screw (x1) can be seen from under the Right Hinge, and then remove the screw (x1).

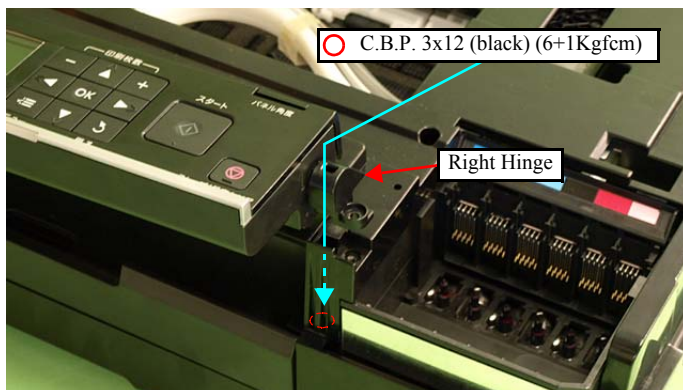


Figure 4-213. Removing the Upper Housing (3)

6. Peel off the double-sided tape A that secures the Panel FFC to the Front Frame, and lift the Upper Housing until the Panel FFC becomes detached from the FFC Holder. (See Fig. 4-214.)
7. Peel off the double-sided tape B that secures the Panel FFC to the Panel Unit. (See Fig. 4-214.)
8. Disconnect the Panel FFC from the connector on the Panel Unit, and remove the Upper Housing together with the Panel Unit.

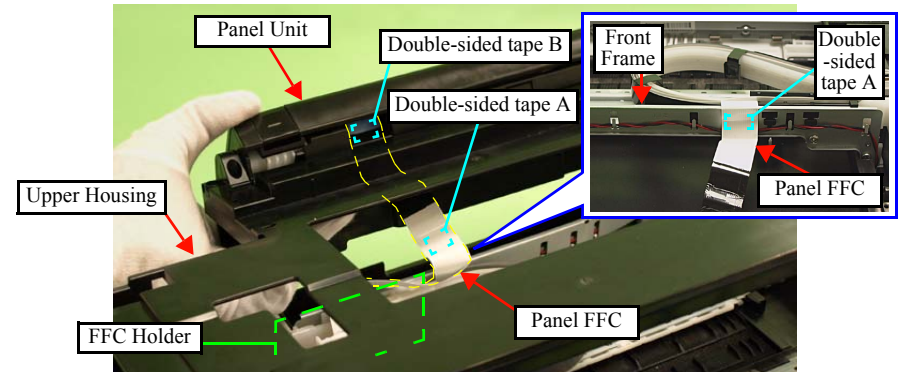


Figure 4-214. Removing the Upper Housing (4)

9. Remove the Panel Unit from the Upper Housing. (See 4.3.2.1 Panel Unit (Artisan 700/PX700W/TX700W) (p194).)



- Tighten the screws in the order indicated in Fig. 4-212.
- Secure the Panel FFC with double-sided tape to the Front Frame. (See Fig. 4-214.)
- Secure the Panel FFC to the Panel Unit with double-sided tape.

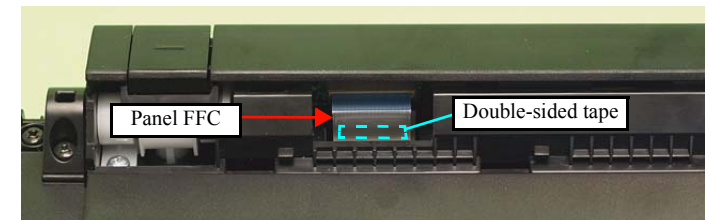


Figure 4-215. Installing the Upper Housing

ADJUSTMENT
REQUIRED

After removing/replacing the Upper Housing, make the specified adjustments. (See Chapter 5 "ADJUSTMENT".)

4.3.1.4 Rear Left Housing (Artisan 700/PX700W/TX700W)

CHECK
POINT

The disassembly/reassembly procedures for Artisan 800/PX800FW/TX800FW differ from those of Artisan 700/PX700W/TX700W, see 4.2.2.6 "Rear Left Housing" (p109) for the procedures.

- Parts/Components need to be removed in advance:
Scanner Unit/Upper Left Housing/Paper Guide Top Assy/Upper Housing
- Removal procedure
 1. Remove the screws (x2) that secure the Rear Left Housing, and remove the Rear Left Housing.

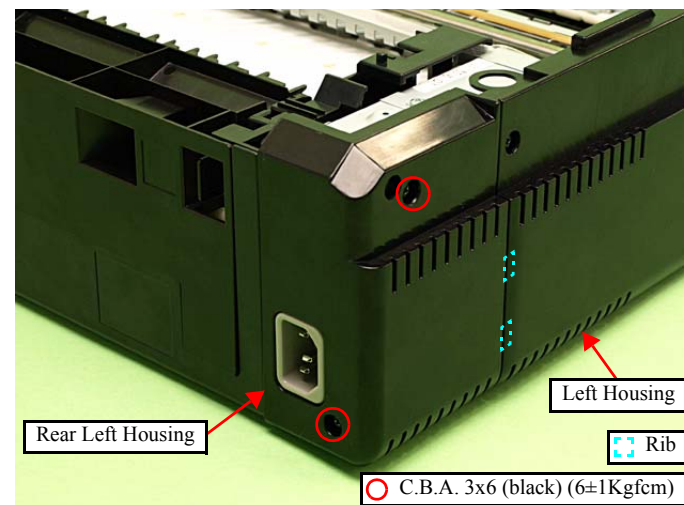


Figure 4-216. Removing the Rear Left Housing

REASSEMBLY



When installing the Rear Left Housing, insert the ribs (x2) of the Rear Left Housing to the inside of the Left Housing. (See Fig. 4-216.)

4.3.1.5 Left Housing/Decoration Belt L (Artisan 700/PX700W/TX700W)

CHECK
POINT



The disassembly/reassembly procedures for Artisan 800/PX800FW/TX800FW differ from those of Artisan 700/PX700W/TX700W, see 4.2.2.7 "Left Housing / Decoration Belt L" (p109) for the procedures.

- Parts/Components need to be removed in advance:

Scanner Unit/Upper Left Housing/Paper Guide Top Assy/Upper Housing/Rear Left Housing

- Removal procedure

1. Remove the Decoration Belt.
2. Remove the screws (x2) that secure the Left Housing.

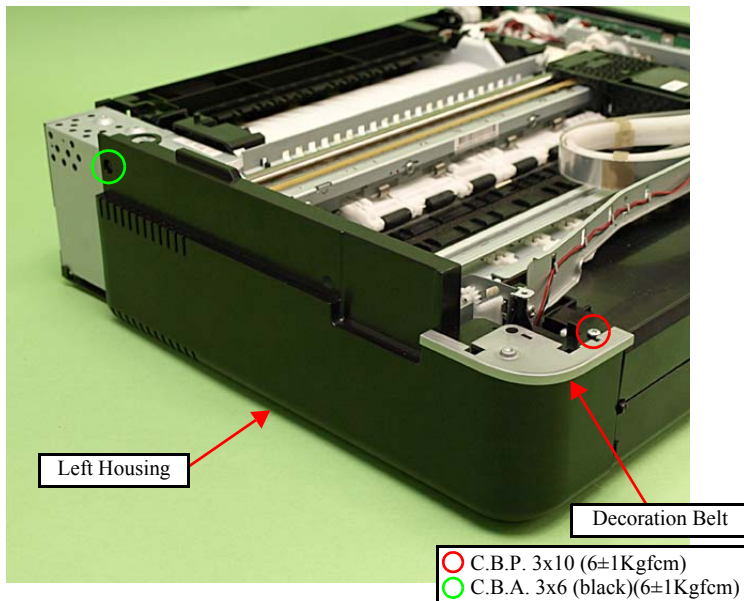


Figure 4-217. Removing the Left Housing/Decoration Belt L (1)

CAUTION



So as to make description easier, the printer in the photographs is placed vertically in the following steps. Be careful about ink spilling if the printer is tilted in practical operation.

3. Release the hooks (x3) on the bottom and dowel (x1) on the front side of the Left Housing, and remove the Left Housing in the direction of the arrow.

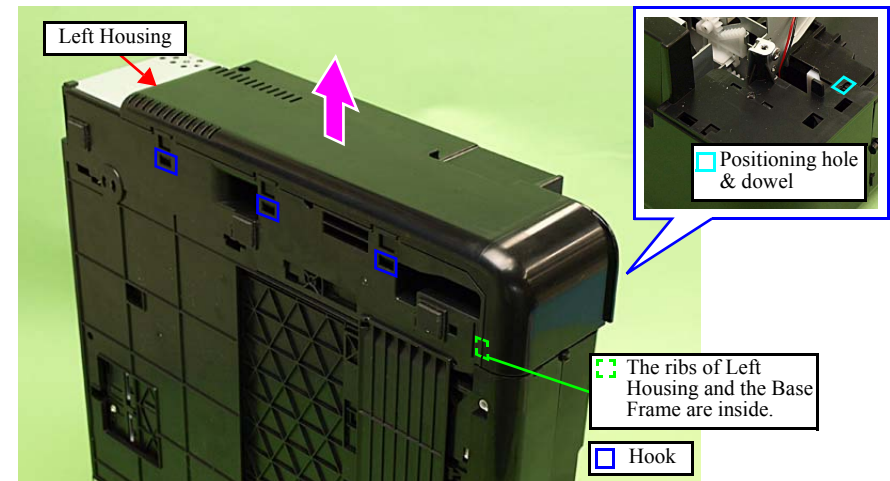


Figure 4-218. Removing the Left Housing/Decoration Belt L (2)

REASSEMBLY



- Align and insert the rib in the front inside of the Left Housing to the inside of the rib of the Base Frame.

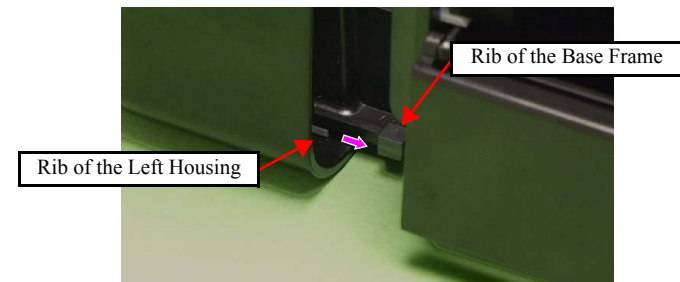


Figure 4-219. Installing the Left Housing

- Align the positioning hole of the Left Housing with the dowel of the Base Frame. (See Fig. 4-218.)

4.3.1.6 Rear Right Housing (Artisan 700/PX700W/TX700W)

CHECK POINT


The disassembly/reassembly procedures for Artisan 800/PX800FW/TX800FW differ from those of Artisan 700/PX700W/TX700W, see 4.2.2.10 "Rear Right FAX Housing" (p112) for the procedures.

- Parts/Components need to be removed in advance:
Scanner Unit/Upper Left Housing/Paper Guide Top Assy/Upper Housing/Hinge
- Removal procedure
 1. Remove the screw (x1) that secures the Rear Right Housing.

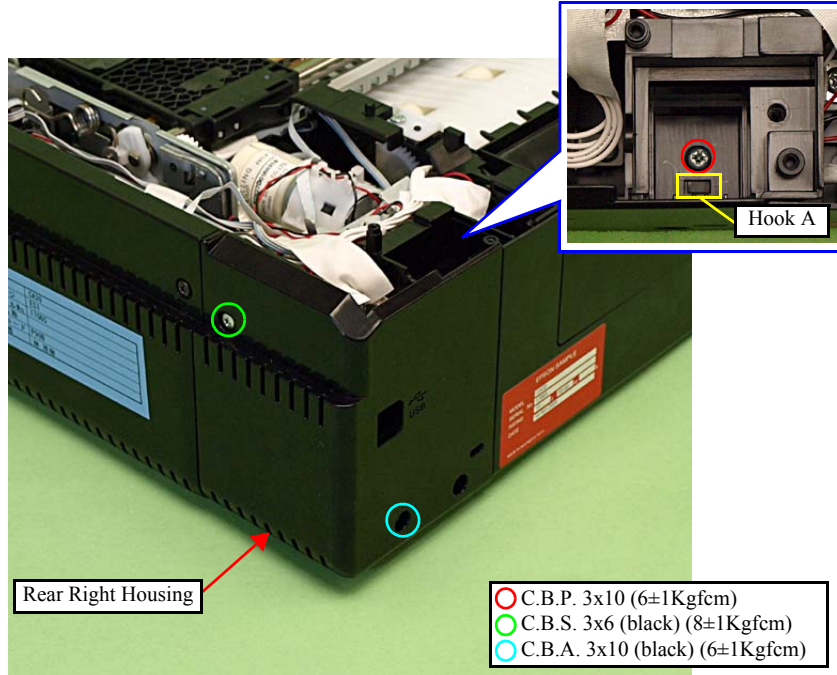


Figure 4-220. Removing the Rear Right Housing (1)

2. Release the ribs (x2) on the right side, and also release the point A, then remove the Rear Right Housing by lifting it in the direction of the arrow. (See Fig. 4-220.)

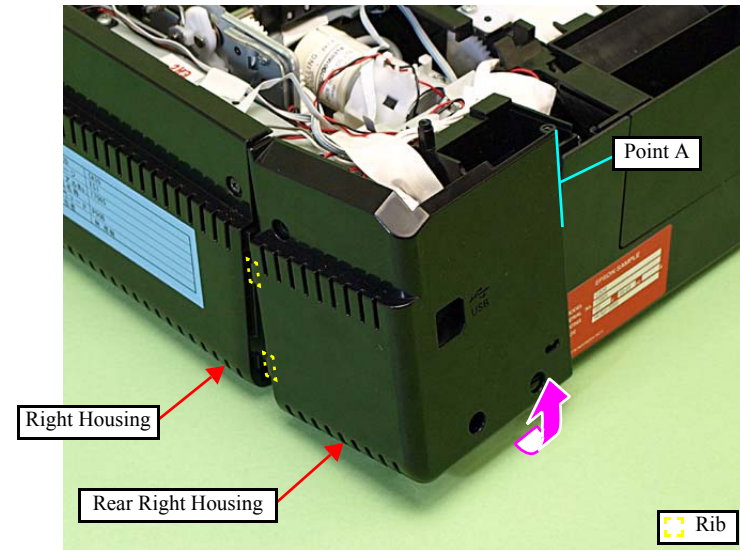


Figure 4-221. Removing the Rear Right Housing (2)



- When installing the Rear Right Housing, insert the ribs (x2) of the Rear Right Housing to inside of the Right Housing. (See Fig. 4-221.)
- When installing the Rear Right Housing, align the point A of the Rear Right Housing with the inside of the Base Frame. (See Fig. 4-221.)

4.3.1.7 Right Housing/Card Cover (Artisan 700/PX700W/TX700W)

**CHECK
POINT**


The disassembly/reassembly procedures for Artisan 800/PX800FW/TX800FW differ from those of Artisan 700/PX700W/TX700W, see 4.2.2.11 "Right Housing / Card Cover" (p113) for the procedures.

- Parts/Components need to be removed in advance:

Scanner Unit/Upper Left Housing/Paper Guide Top Assy/Upper Housing/Hinge/Rear Right Housing

- Removal procedure

1. Remove the screw (x1) that secures the Right Housing.

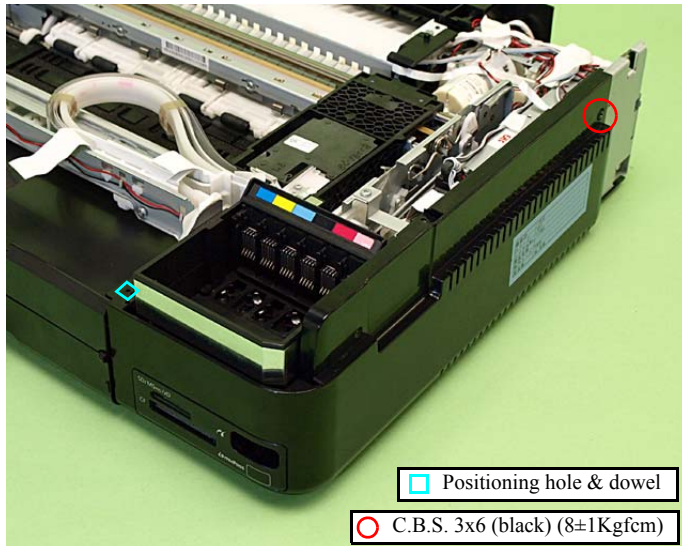


Figure 4-222. Removing the Right Housing/Card Cover (1)



CAUTION
When removing the Right Housing, be careful not to let the Card Cover interfere with the Card Slot Assy or the Card Cover may be damaged.

2. Release the dowel (x1) on the front side (See Fig. 4-222) and hooks (x3) on the bottom of the Right Housing, and remove the Right Housing.

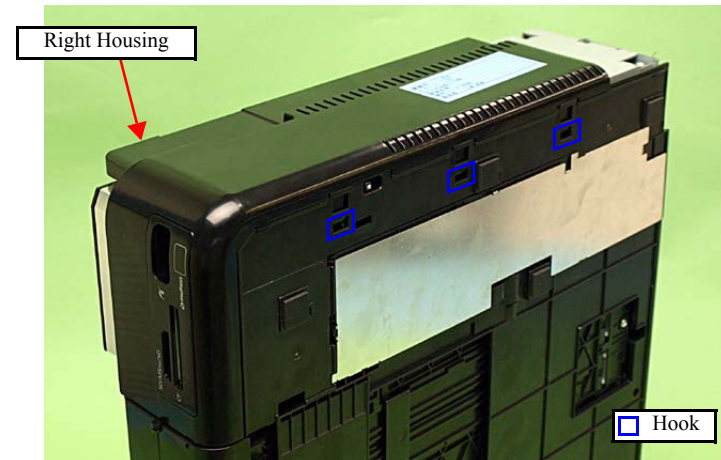


Figure 4-223. Removing the Right Housing/Card Cover (2)

3. Release the hooks (x2) on the back of the Right Housing and remove the Card Cover.

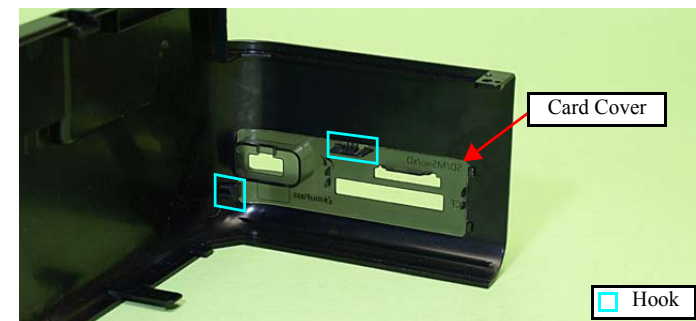


Figure 4-224. Removing the Right Housing/Card Cover (3)

REASSEMBLY



- Align and insert the positioning hole of the Right Housing to the dowel of the Base Frame. (See Fig. 4-222)
- Attach the Card Cover after installing the Right Housing to the printer.
- When attaching the Card Cover, insert the ribs (x2) of the Card Cover to the inside of the Right Housing, and secure it with the hooks (x2).

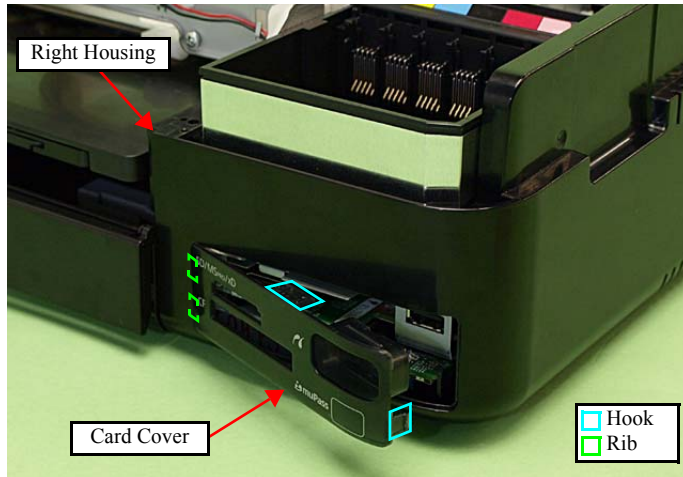


Figure 4-225. Attaching the Card Cover

4.3.2 Removing the Circuit Board (Artisan 700/PX700W/TX700W)

4.3.2.1 Panel Unit (Artisan 700/PX700W/TX700W)

CHECK POINT



The disassembly/reassembly procedures for Artisan 800/PX800FW/TX800FW differ from those of Artisan 700/PX700W/TX700W, see 4.2.3.1 "Panel Unit" (p115) for the procedures.

- Parts/Components need to be removed in advance:
Scanner Unit/Upper Left Housing/Paper Guide Top Assy/Upper Housing
- Removal procedure
 1. Open the Panel Unit. (See Fig. 4-226.)
 2. Lift the Right Hinge and detach the Panel FFC Guide from the Upper Housing.

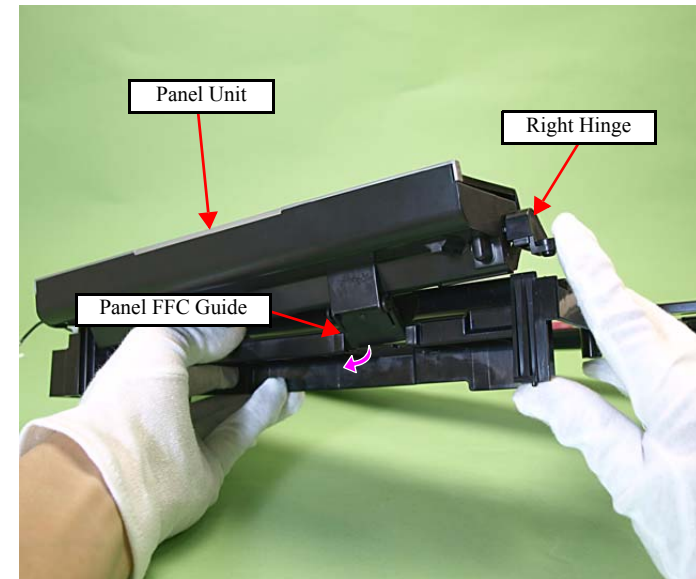


Figure 4-226. Removing the Panel Unit (1)

- Tilt the Panel Unit by 45 degrees to align the rib of the shaft on the left side of the Panel Unit with the groove of the Upper Housing.

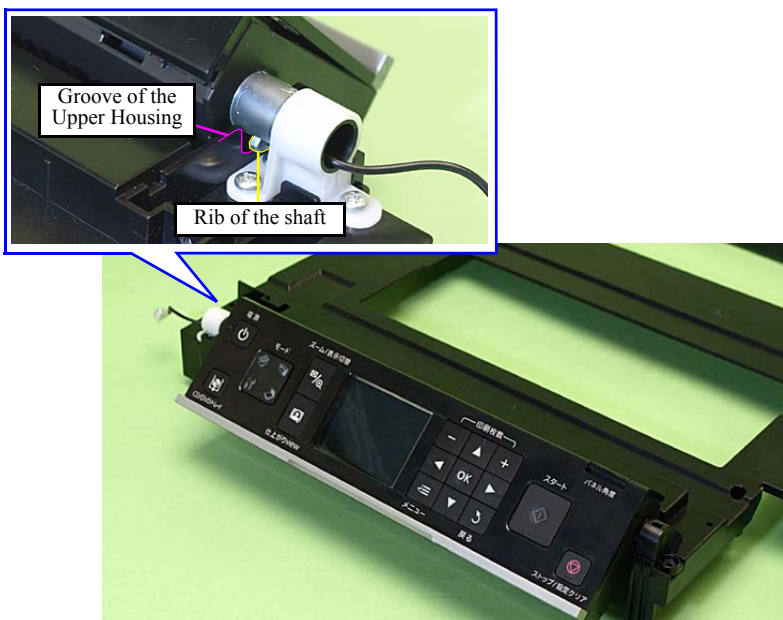


Figure 4-227. Removing the Panel Unit (2)

- Lift the Panel Unit so as not to let the Right Hinge interfere with the Upper Housing, and remove the shaft from the bushing on the left side of the Panel Unit, and then remove the Panel Unit.



Figure 4-228. Removing the Panel Unit (3)



After replacing the Panel Unit, be sure to perform the required lubrication. (See Chapter 6 "MAINTENANCE".)

4.3.2.2 Main Board/Grounding Plate M/B (Artisan 700/PX700W/TX700W)



The disassembly/reassembly procedures for Artisan 800/PX800FW/TX800FW differ from those of Artisan 700/PX700W/TX700W, see 4.2.3.2 "Main Board / Grounding Plate M/B" (p117) for the procedures.



When printing the CDR, the CDR Tray feed amount is adjusted with compensation depending on the deterioration of the CDR Tray, and the correction level is determined by the number of printed CDRs. If the data on the EEPROM can not be copied when replacing the Main Board, banding may occur while printing CDR due to improper corrections caused because the data of the number of printed CDRs can not be transferred. When this happens, replace the CDR Tray Assy with a new one together with the Main Board. (See 4.2.4.8 "CDR Tray Assy" (p140).)

- ❑ Parts/Components need to be removed in advance:
Scanner Unit/Upper Left Housing/Paper Guide Top Assy/Upper Housing/Hinge/Rear Right Housing/Right Housing
- ❑ Removal procedure
 1. Disconnect all the cables and FFCs connected to the section A on the Main Board. (See "Connectors on the Main Board" (p. 117).)

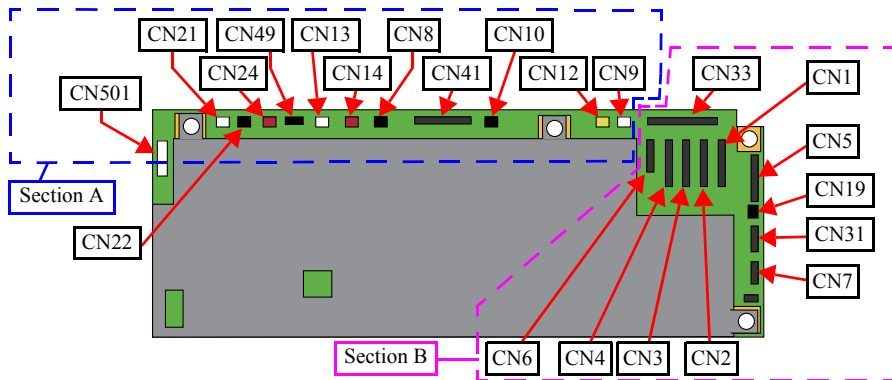


Figure 4-229. Connector positions on the Main Board

2. Remove the screw (x1) that secures the Grounding Plate M/B, and remove the Grounding Plate M/B together with the Grounding Plate Sheet M/B.

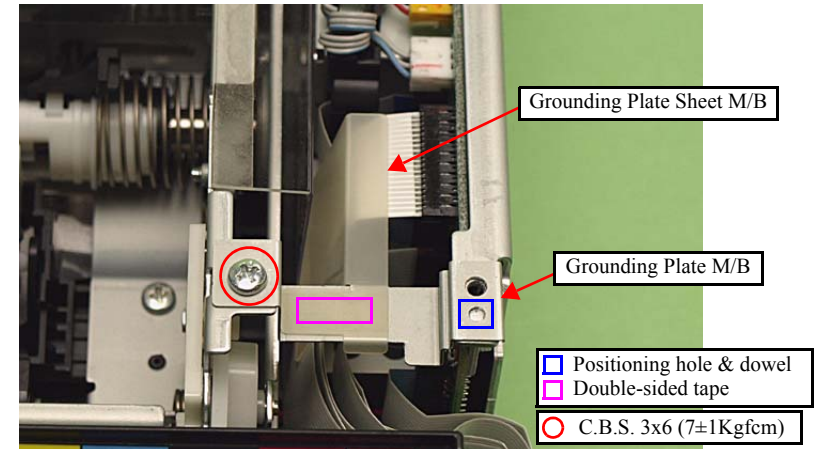


Figure 4-230. Removing the Grounding Plate M/B

3. Remove the screw that secures the Ferrite Core Holder A, and remove the Ferrite Core Holder A.

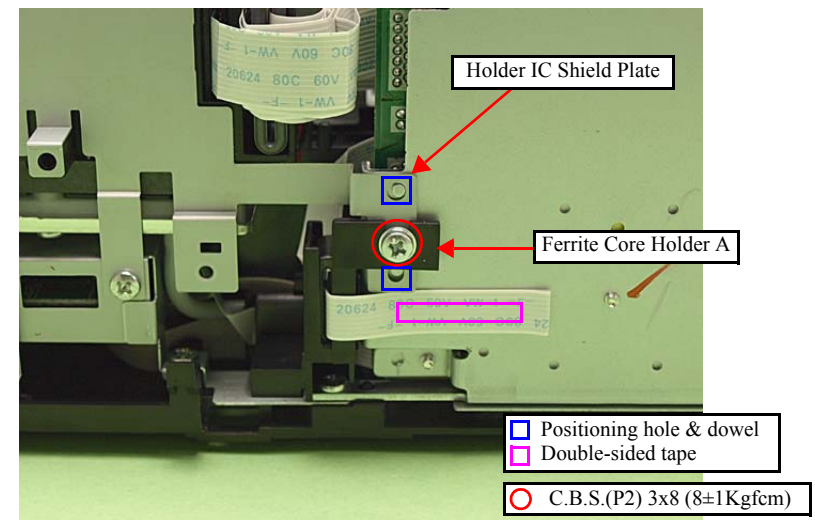


Figure 4-231. Removing the Ferrite Core Holder A

4. Disconnect the cables and FFCs connected to the section B of the Main Board. (See Fig. 4-229.)
5. Remove the screw (x1) that secures the Right Cable Frame and the Main Board. (See Fig. 4-229.)
6. Remove the screws (x3) that secure the Main Board Unit and remove the Main Board Unit.

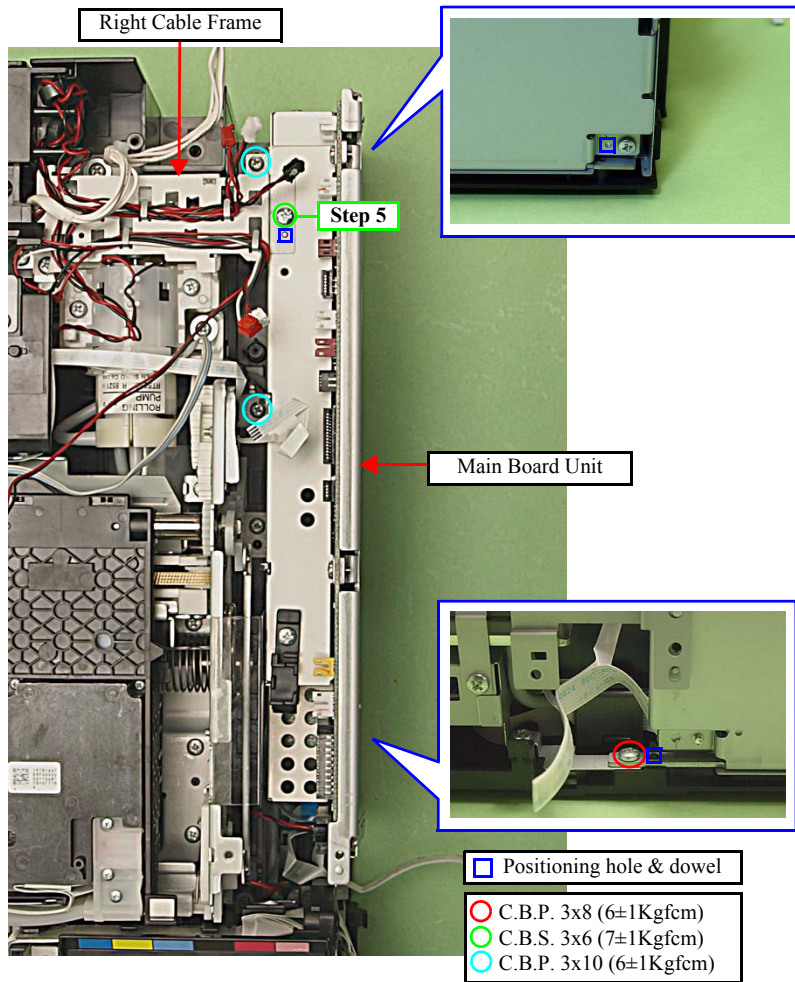


Figure 4-232. Removing the Main Board (1)

7. Remove the screws (x6) that secure the Upper Shield Plate M/B and remove the Upper Shield Plate M/B.

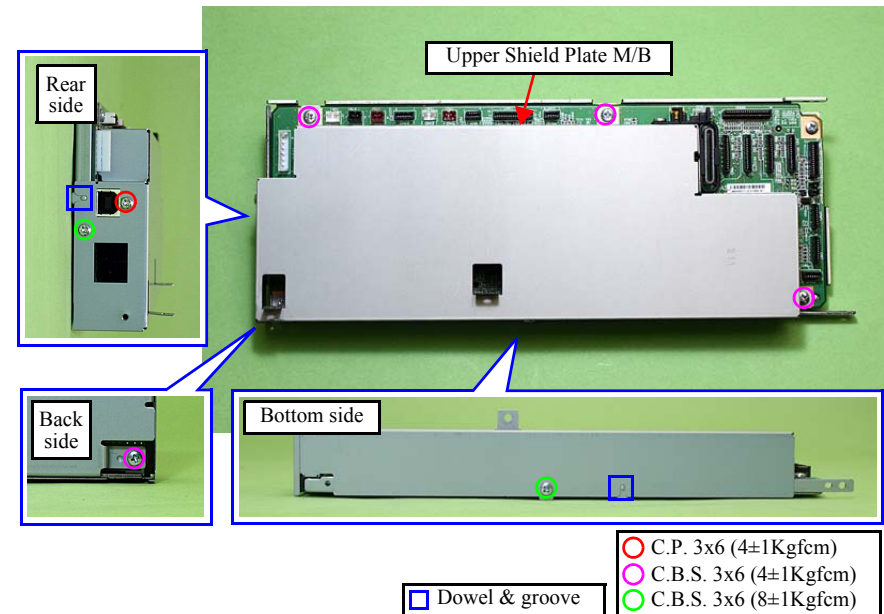


Figure 4-233. Removing the Main Board (2)

8. Remove the screws (x3) that secure the Main Board, and remove the Lower Shield Plate M/B from the Main Board.

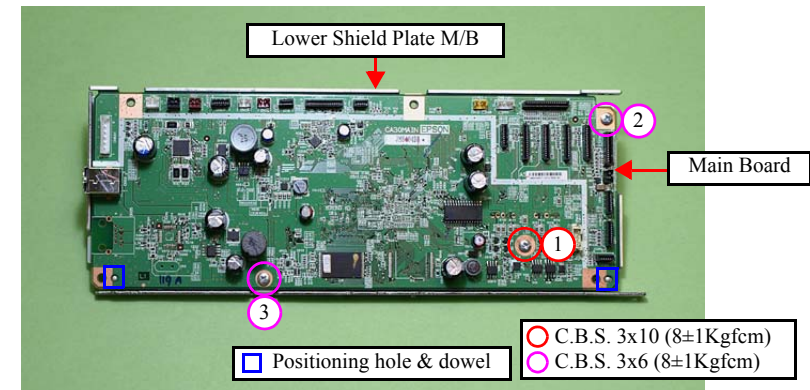


Figure 4-234. Removing the Main Board (3)

REASSEMBLY



- Align the positioning holes (x2) on the Main Board with the dowels (x2) of the Lower Shield Plate M/B. (See Fig. 4-234.)
- Tighten the screws in the order given in Fig. 4-234.
- Align the dowels (x2) of the Lower Shield Plate M/B with the grooves (x2) of the Upper Shield Plate M/B. (See Fig. 4-233.)
- Align the positioning holes (x2) of the Main Board Unit with the dowels (x2) of the Base Frame. (See Fig. 4-232.)
- Align the dowels (x2) of the Main Board Unit with the positioning holes (x2) of the Right Cable Frame. (See Fig. 4-232.)
- Insert the rib (x1) of the Grounding Plate M/B to the hole of the Main Board Unit, and align the positioning hole (x1) of the Grounding Plate M/B with the dowel (x1) of the Main Board Unit, and attach the Grounding Plate M/B. (See Fig. 4-232, Fig. 4-235.)

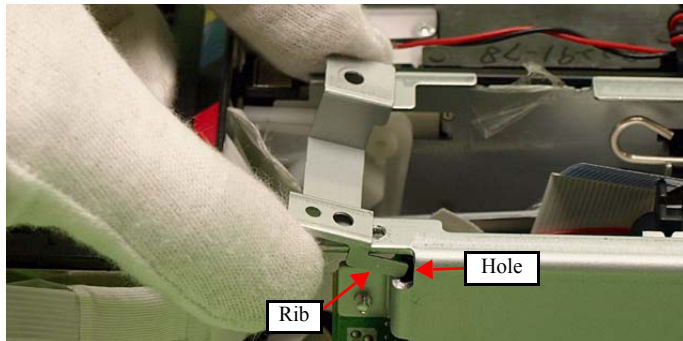


Figure 4-235. Attaching the Grounding Plate M/B

REASSEMBLY



- When replacing the Grounding Plate Sheet M/B, insert the sheet between the FFC and the Main Frame, and secure it with double-sided tape to the Grounding Plate M/B. (See Fig. 4-230.)
- When attaching the Ferrite Core Holder A, follow the procedure below.
 1. Align the dowels (x2) of the Main Board Unit with the positioning holes (x2) of the Holder IC Shield Plate.
 2. Secure the Ferrite Core Holder A and the Holder IC Shield Plate to the Main Board Unit with the screw. (See Fig. 4-231.)
- When attaching the CR Encoder FFC, follow the procedures below.
 1. Put the CR Encoder FFC through the ferrite core.
 2. Connect the CR Encoder FFC to the connector (CN6) on the Main Board.
 3. Insert the rib of the Ferrite Core Holder B to the hole of the Main Board, and secure it with the screw (x1).

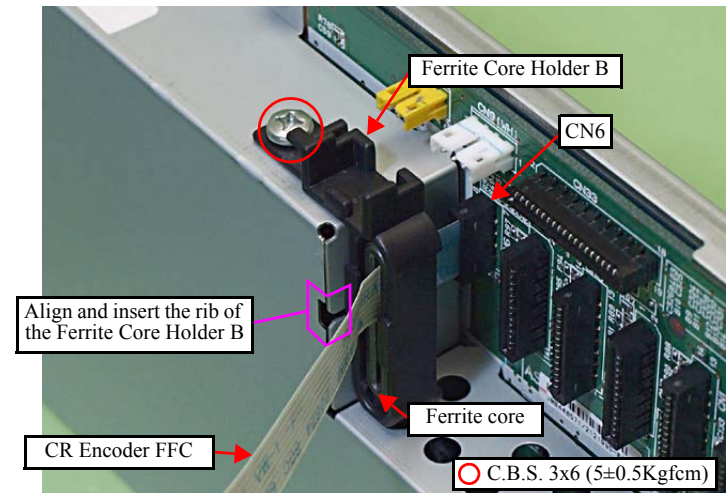


Figure 4-236. Attaching the CR Encoder FFC

- For routing the FFCs, see 4.4 "Routing FFC/cables" (p202).

ADJUSTMENT
REQUIRED

- When replacing the Main Board, the MAC address need to be set if the EEPROM data could not be read from the old Main Board. In this case, attach the new “Label, MAC address (Parts number: 1489232)” to the position shown in Fig. 4-237 and execute “5.2.6 “MAC Address Setting” (p223)”.



Figure 4-237. Position for the MAC Address Label

- After removing/replacing the Main Board, make the specified adjustments. (See Chapter 5 “ADJUSTMENT”.)

4.3.2.3 Card Slot Assy (Artisan 700/PX700W/TX700W)

CHECK
POINT

- The disassembly/reassembly procedures for Artisan 800/PX800FW/TX800FW differ from those of Artisan 700/PX700W/TX700W, see 4.2.3.5 “Card Slot Assy” (p123) for the procedures.
- The Card Slot Assy includes the SUB Board and the STG Board.

WARNING



When powering this product, high-voltage current may be applied on the SUB Board. To prevent ELECTRIC SHOCK, do not touch the SUB Board section when the power is ON.

If the shock should happen, the flowing current is very tiny, about a few hundreds μA , therefore it will not do any harm on the human body.

- Parts/Components need to be removed in advance:
Scanner Unit/Upper Left Housing/Paper Guide Top Assy/
Upper Housing/Hinge/Rear Right Housing/Right Housing/Main Board Unit/
CSIC Assy/Cartridge Box Unit/Ink Supply Tube Assy
- Removal procedure
 1. Remove the screws (x2) that secure the Card Slot Assy and remove the Grounding Plate.

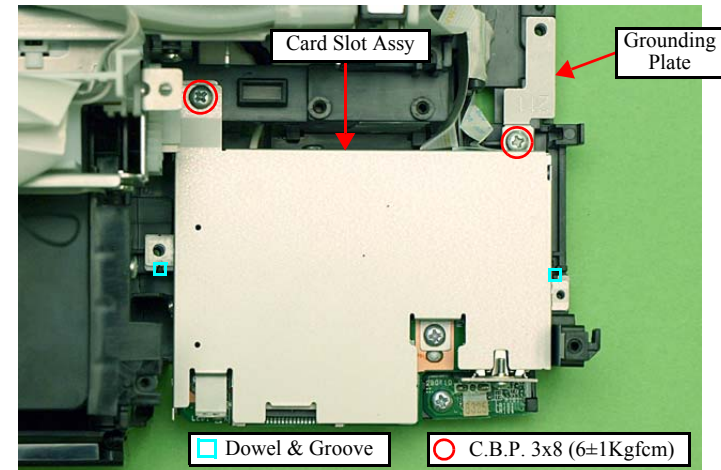


Figure 4-238. Removing the Card Slot Assy (1)

- Disconnect the AID cable from the connector on the SUB Board, and remove the Card Slot Assy.

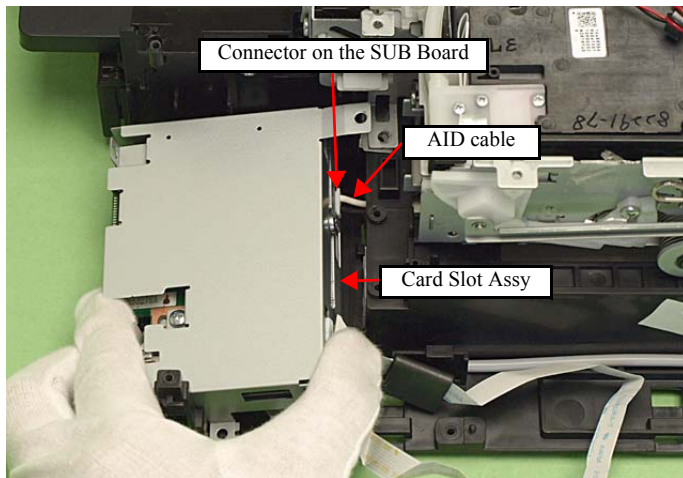


Figure 4-239. Removing the Card Slot Assy (2)

REASSEMBLY



- Connect the AID cable properly to the connector on the SUB Board. (See Fig. 4-239.)
- Align the grooves (x2) of the Card Slot Assy with the dowels (x2) of the Base Frame. (See Fig. 4-238.)
- When attaching the Grounding Plate, install it over the Card Slot Assy, and tighten them together with the screw. (See Fig. 4-238.)
- For routing the FFCs, see 4.4 "Routing FFC/cables" (p202).

ADJUSTMENT REQUIRED



After removing/replacing the Card Slot Assy, make the specified adjustments. (See Chapter 5 "ADJUSTMENT".)

4.3.3 Disassembling the Scanner Unit (Artisan 700/PX700W/TX700W)

CHECK POINT



The disassembly/reassembly procedures for Artisan 800/PX800FW/TX800FW differ from those of Artisan 700/PX700W/TX700W, see 4.2.5 "Disassembling Scanner Unit" (p167) for the procedures.

4.3.3.1 Document Cover

- Parts/Components need to be removed in advance:
Scanner Unit/ADF Unit
- Removal procedure
 1. Release the dowels (x2) and ribs (x2) of the Document Cover with the Document Cover closed, and remove the Document Cover from the Scanner Upper Housing in the direction of the arrow.

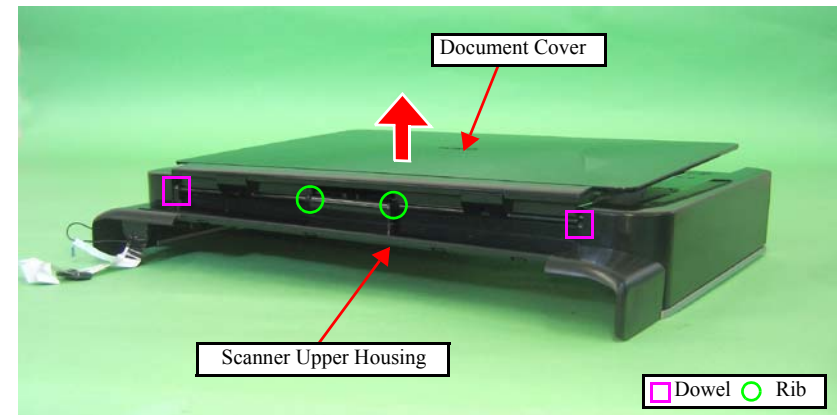


Figure 4-240. Removing the Document Cover

4.3.3.2 Scanner Upper Housing (Artisan 700/PX700W/TX700W)

- Parts/Components need to be removed in advance:

Scanner Unit/ADF Unit/Document Cover

- Removal procedure

CAUTION



- It is recommended to remove the Scanner Upper Housing in a clean room or on a clean bench to keep away from dust and dirt.
- Be careful not to damage the document glass on the Scanner Upper Housing.

1. Remove the screws (x7) that secure the Scanner Upper Housing.
2. Release the hooks (x3) that secure the Scanner Upper Housing.

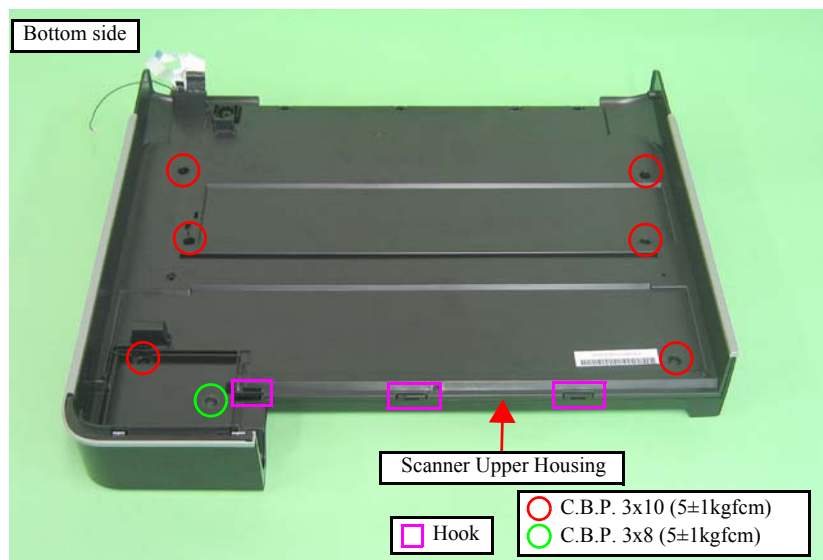


Figure 4-241. Removing the Scanner Upper Housing (1)

3. Release the ribs (x4) on the Scanner Upper Housing, and remove the Scanner Upper Housing in the direction of the arrow.

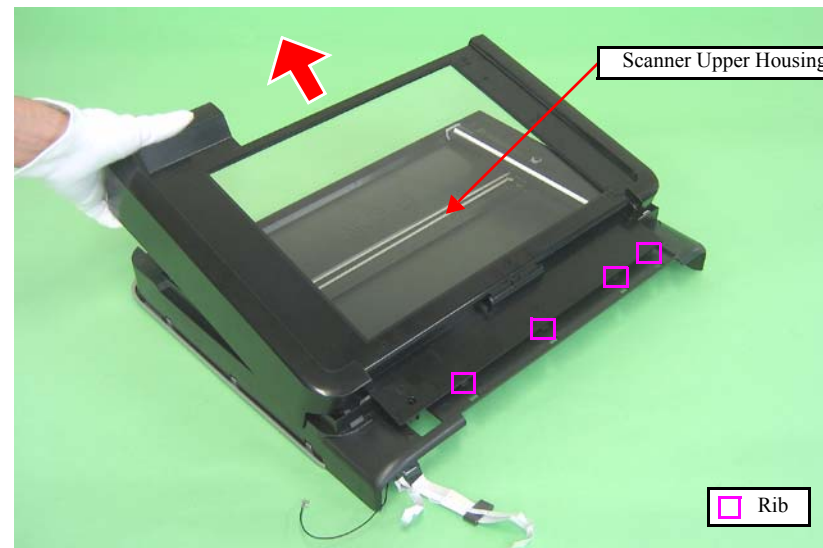


Figure 4-242. Removing the Scanner Upper Housing (2)

REASSEMBLY



When installing the Scanner Upper Housing, see “4.2.5.1 “Scanner Upper Housing (Artisan 800/PX800FW/TX800FW)” (p167)”.

4.4 Routing FFC/cables

ADF/SCANNER (ARTISAN 800/PX800FW/TX800FW)

No.	FFC/cable name	CN No.*	Remarks
1	ADF Motor Cable	CN25	Artisan 800/PX800FW/TX800FW only
2	ADF Sensor Cable	CN51	Artisan 800/PX800FW/TX800FW only
3	Scanner Cover Open Sensor FFC	CN10	Ferrite Core x1
4	Scanner Carriage FFC	CN41	Ferrite Core x1
5	Scanner CR Encoder FFC	CN49	---
6	Grounding Wire (x2)	---	---

Note *: See Fig. 4-245 for the connector positions on the Main Board (Artisan 800/PX800FW/TX800FW).

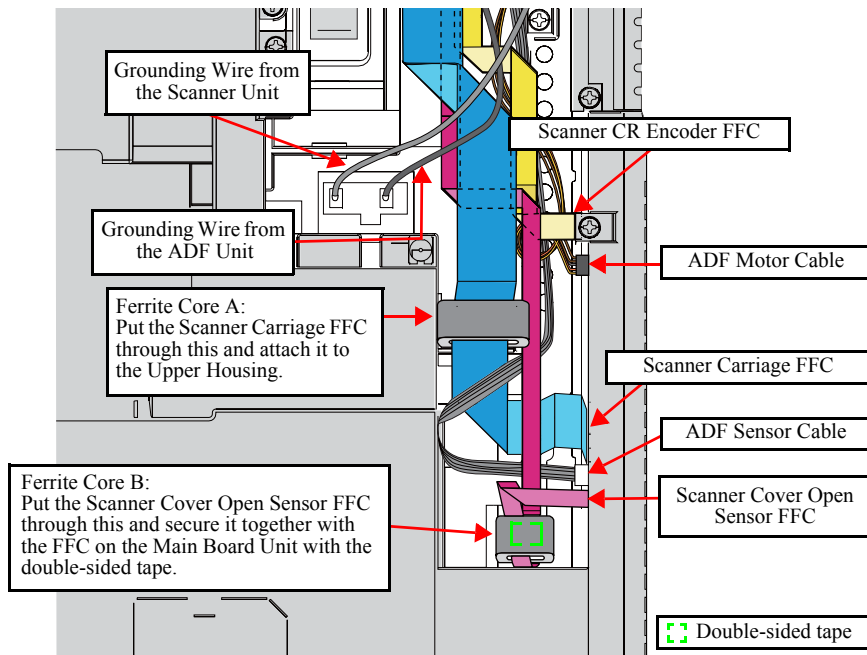


Figure 4-243. ADF/Scanner (Artisan 800/PX800FW/TX800FW)

ADF/SCANNER (ARTISAN 700/PX700W/TX700W)

No.	FFC/cable name	CN No.*	Remarks
1	Scanner Cover Open Sensor FFC	CN10	Ferrite Core x1
2	Scanner Carriage FFC	CN41	Ferrite Core x1
3	Scanner CR Encoder FFC	CN49	---
4	Grounding Wire (x1)	---	---

Note *: See Fig. 4-247 for the connector positions on the Main Board (Artisan 700/PX700W/TX700W).

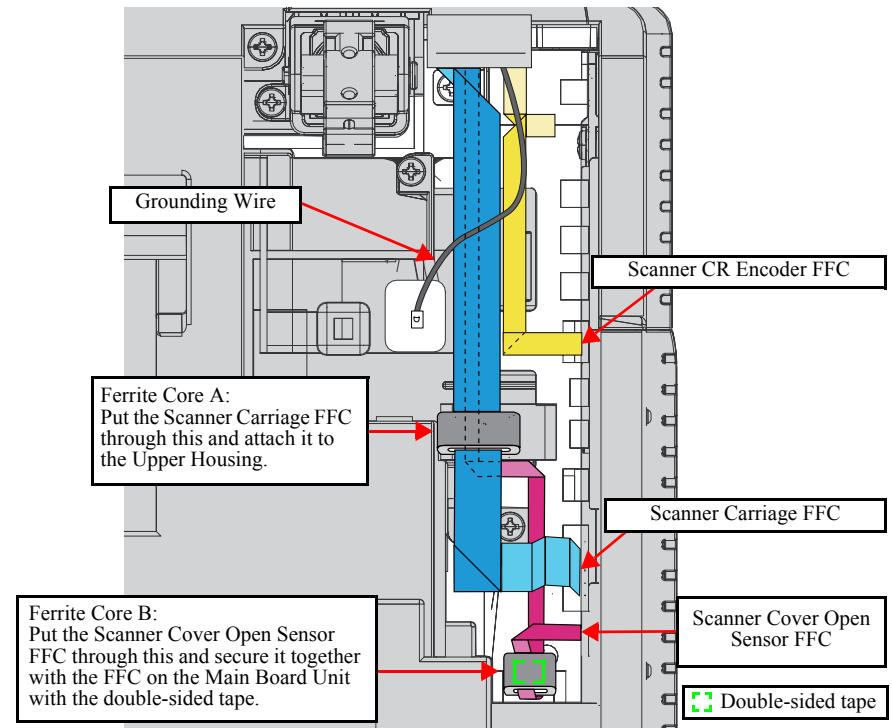


Figure 4-244. ADF/Scanner (Artisan 700/PX700W/TX700W)

MAIN BOARD (TOP SIDE) (ARTISAN 800/PX800FW/TX800FW)

The following describes the routing orders of the cables and FFCs that are connected to the Main Board.

Start	Cable	Route	CN No.
1	PE Sensor Cable (Ferrite Core x2)	a → groove → I → J → b	CN9
	PF Encoder FFC	Double-sided tape (x4)	CN8
2	PF Motor Cable (Ferrite Core x1)	H → c → F → E → B	CN22
3	CR Motor Cable (Ferrite Core x1)	K → d → F → E → B	CN21
4	Decompression Pump Motor Cable	K → F → E → B	CN24
5	Duplex Unit Sensor Cable	G → D → C	CN13
	CDR Tray Sensor Cable		CN14
	Photo Tray Sensor Cable		CN12
6	Power Supply Unit Cable	Align it to standard line → A	CN501

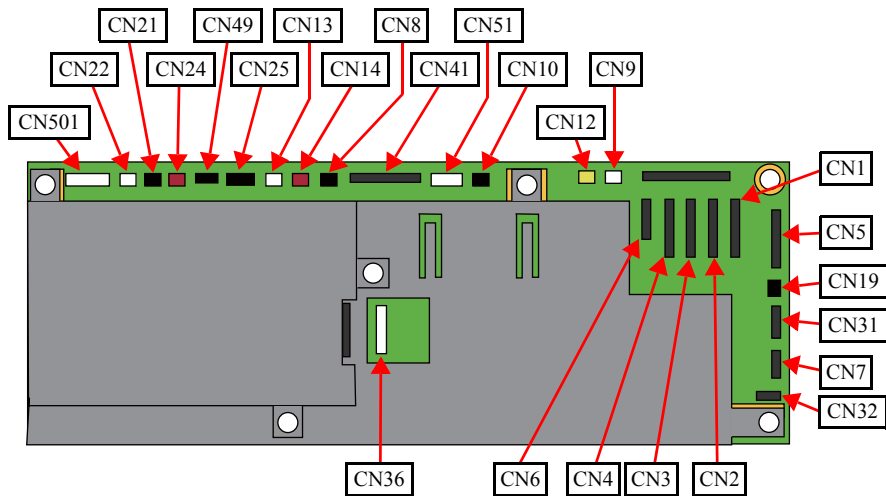


Figure 4-245. Connector positions on the Main Board (Artisan 800/PX800FW/TX800FW)

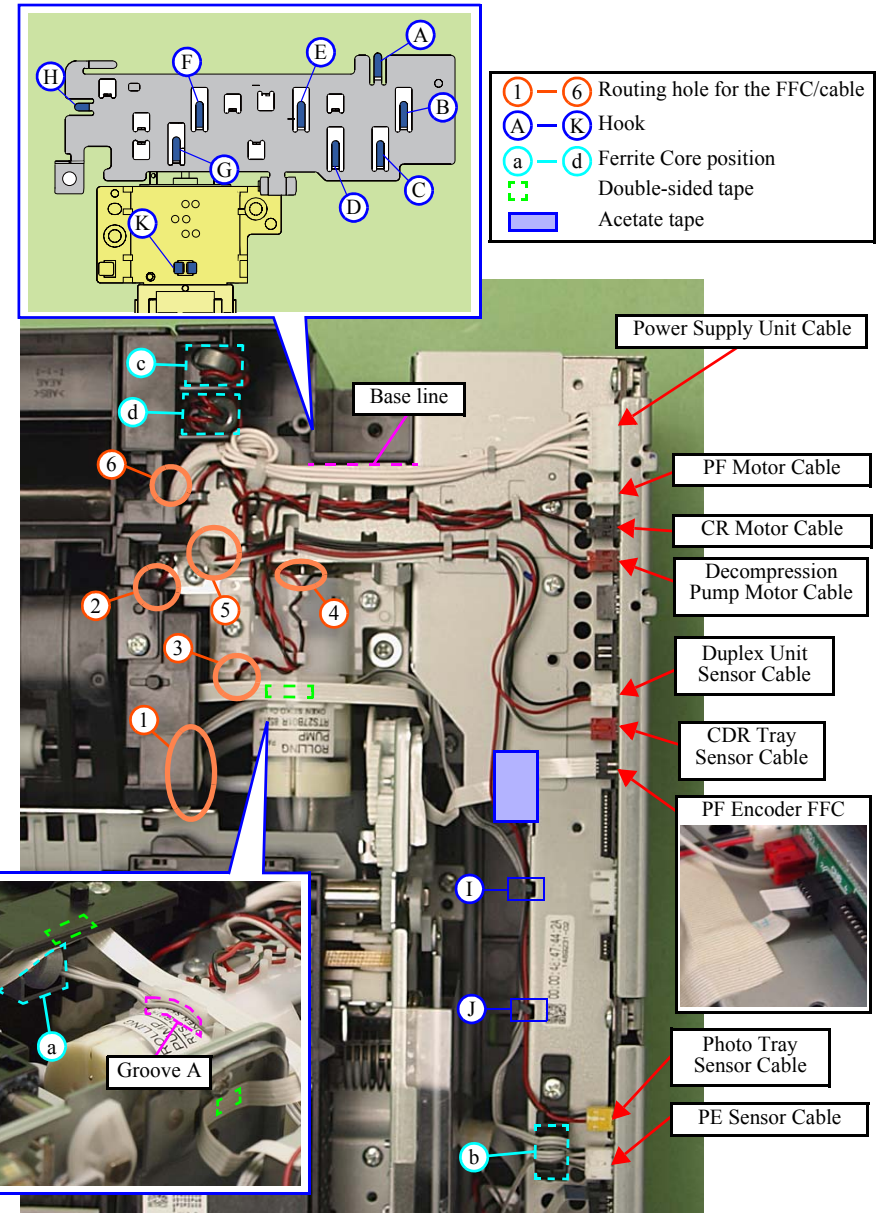


Figure 4-246. Main Board (Artisan 800/PX800FW/TX800FW)

MAIN BOARD (TOP SIDE) (ARTISAN 700/PX700W/TX700W)

Following describes routing the cables and FFCs that connect to the Main Board.

Start	Cable	Route	CN No.
1	PE Sensor Cable (Ferrite Core x2)	a → groove A → F → G → b	CN9
	PF Encoder FFC	Double-sided tape (x4)	CN8
2	PF Motor Cable (Ferrite Core x1)	E → c → C → B	CN22
3	CR Motor Cable (Ferrite Core x1)	H → d → C → B	CN21
4	Decompression Pump Motor Cable	H → C → B	CN24
5	Duplex Unit Sensor Cable	D → A	CN13
	CDR Tray Sensor Cable		CN14
	Photo Tray Sensor Cable		CN12
6	Power Supply Unit Cable	Groove B (Insert it between Base Frame and Decompression Pump Unit)	CN501

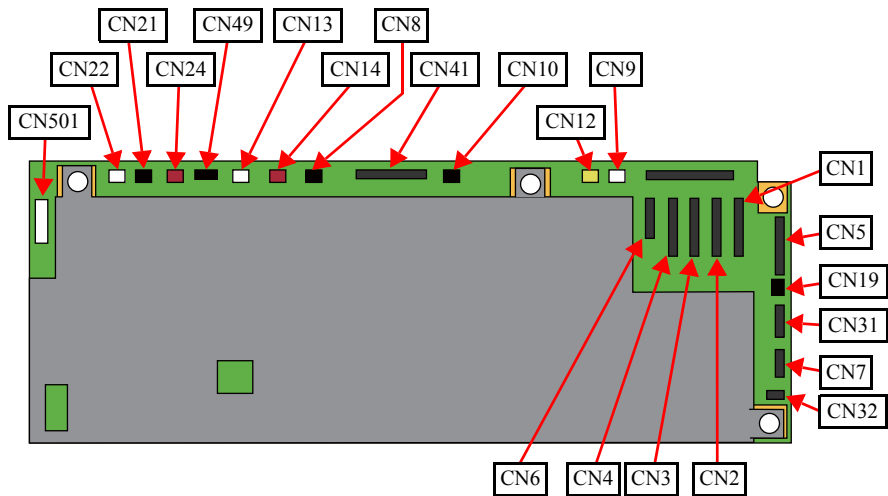


Figure 4-247. Connector positions on the Main Board (Artisan 700/PX700W/TX700W)

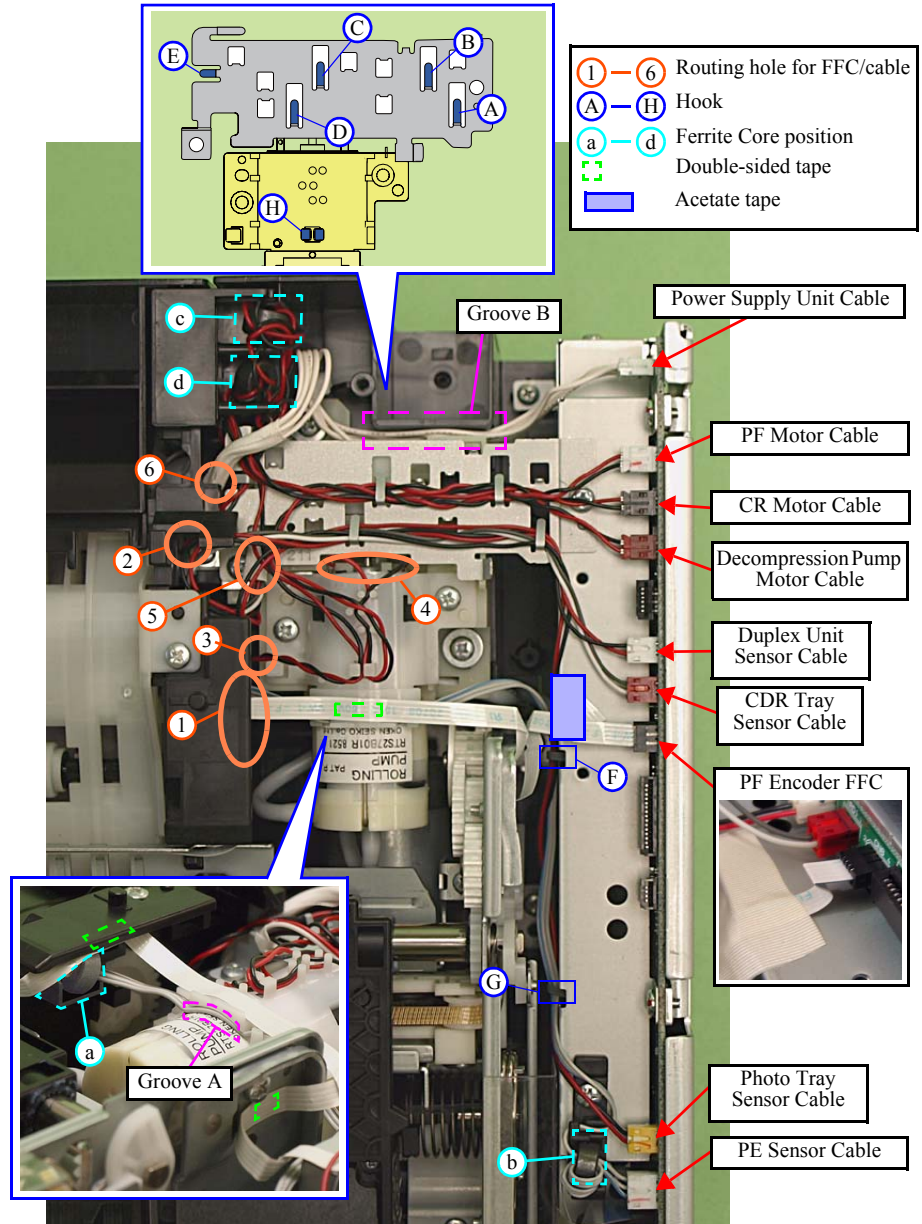


Figure 4-248. Main Board (Artisan 700/PX700W/TX700W)

CARD SLOT ASSY

No.	FFC/cable name	CN No.*	Remarks
1	I/F FFC (Infra-red)	CN32	Mounted only in Japanese models.
2	SUB FFC	CN7	---
3	STG FFC	CN31	Ferrite Core x2

Note *: See Fig. 4-245 for the connector positions on the Main Board.

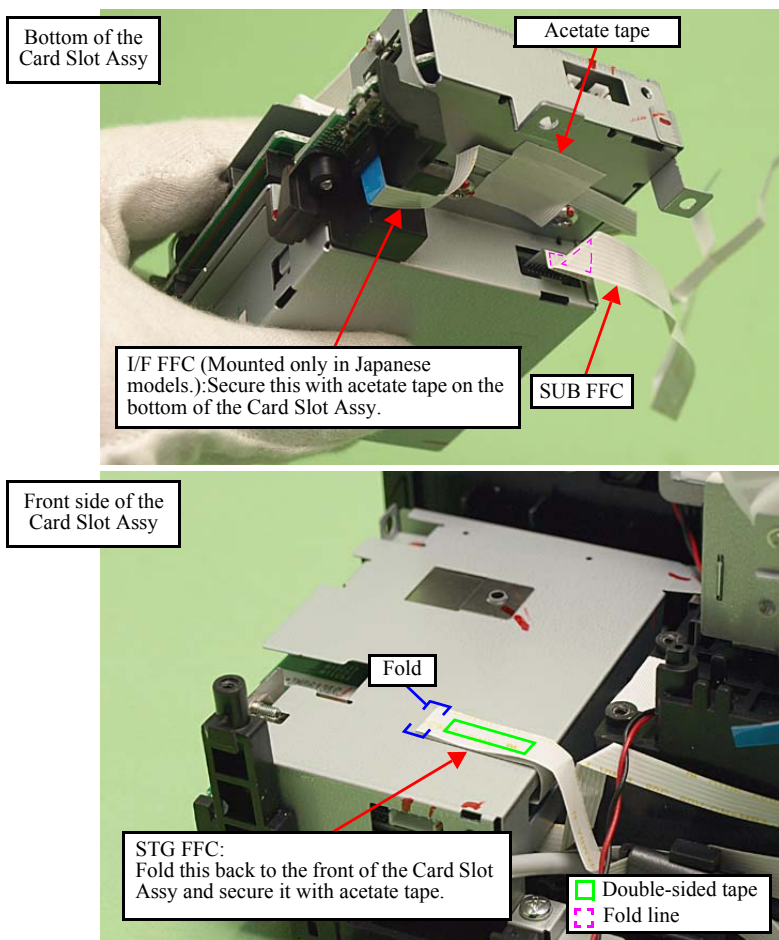


Figure 4-249. Card Slot Assy (1)

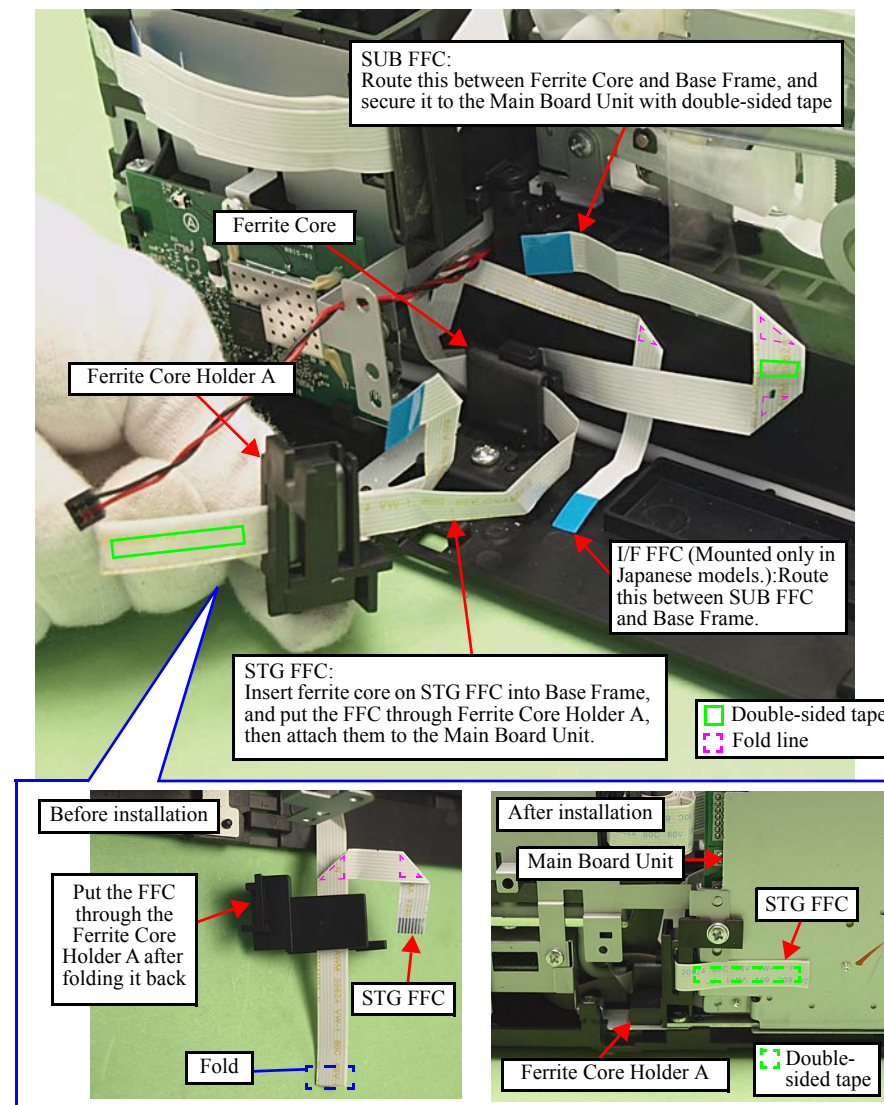


Figure 4-250. Card Slot Assy (2)

**MAIN BOARD (REAR SIDE OF THE CARTRIDGE BOX)
(ARTISAN 800/PX800FW/TX800FW)**

No.	FFC/cable name	CN No.*	Remarks
1	CR Encoder FFC	CN6	Ferrite Core x2
2	Head FFC (x4)	CN1,2,3,4	Ferrite Core x1
3	CSIC FFC	CN5	---

Note *: See Fig. 4-245 for the connector positions on the Main Board.

**MAIN BOARD (BEHIND CARTRIDGE BOX)
(ARTISAN 700/PX700W/TX700W)**

No.	FFC/cable name	CN No.*	Remarks
1	Panel FFC	CN33	Ferrite core (x1)
2	CR Encoder FFC	CN6	---
3	Head FFC (x4)	CN1,2,3,4	---
4	CSIC FFC	CN5	---

Note *: See Fig. 4-247 for the connector positions on the Main Board.

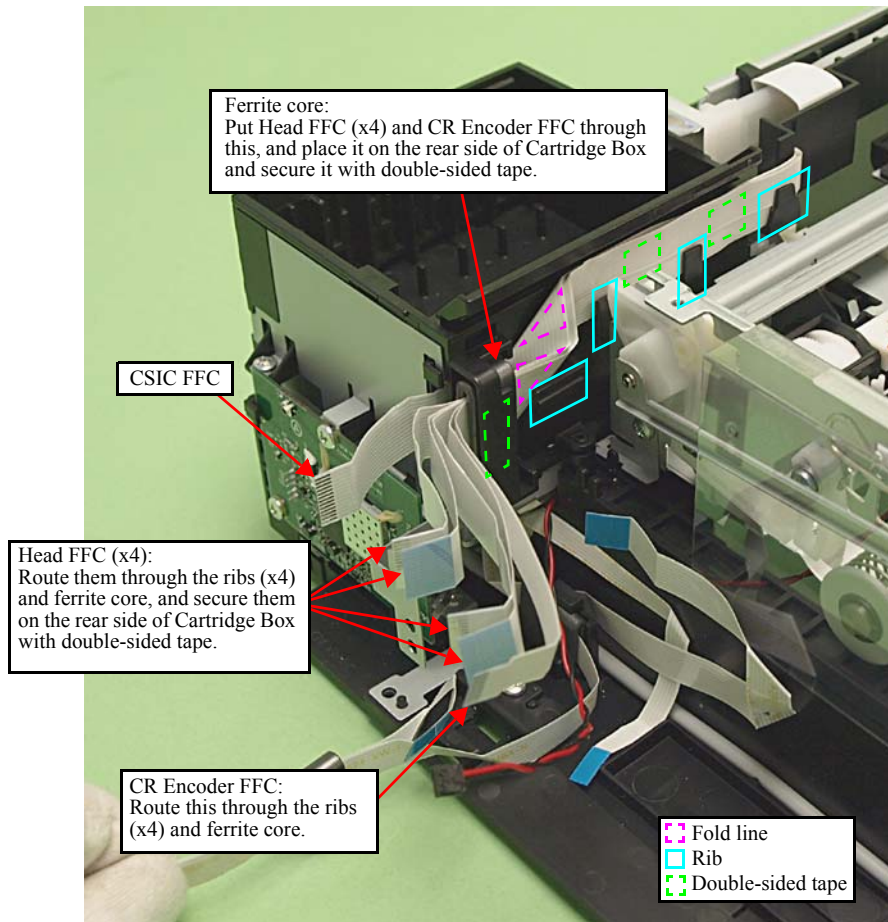


Figure 4-251. Rear side of the Cartridge Box (Artisan 800/PX800FW/TX800FW)

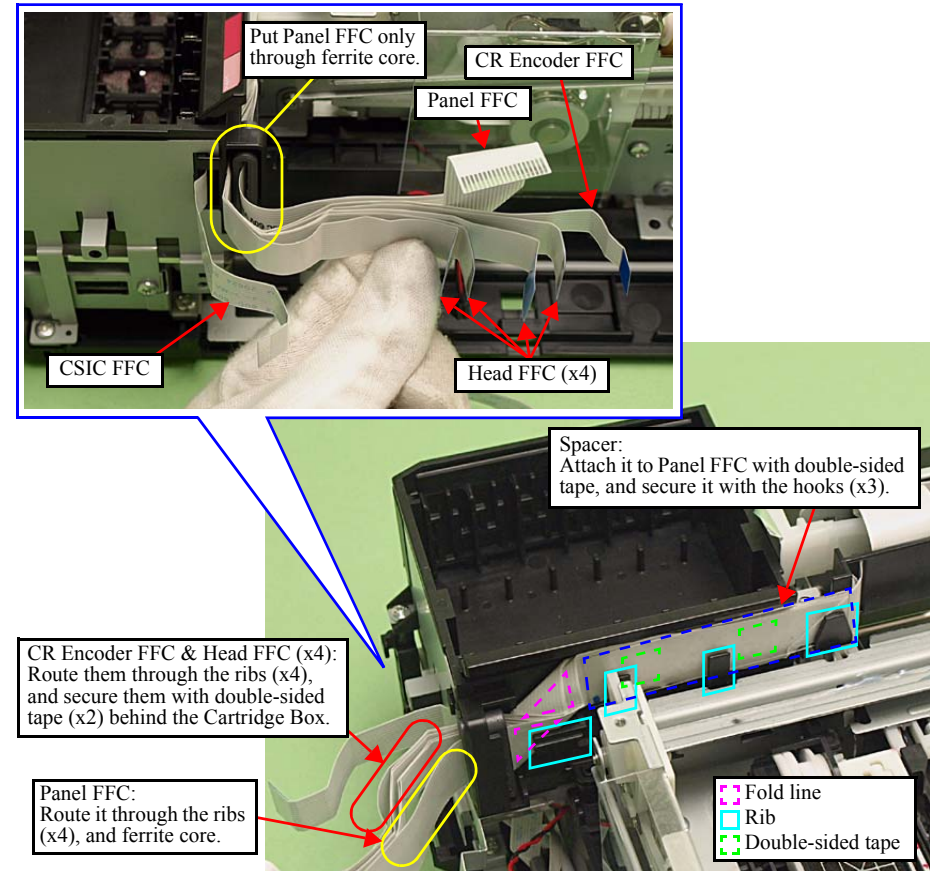


Figure 4-252. Routing to the FFC Holder (Artisan 700/PX700W/TX700W)

ROUTING THROUGH THE FFC HOLDER

No.	FFC/cable name	CN No.*	Remarks
1	CR Encoder FFC	CN6	---
2	Head FFC (x4)	CN1,2,3,4	---

See Fig. 4-245 for the connector positions on the Main Board.

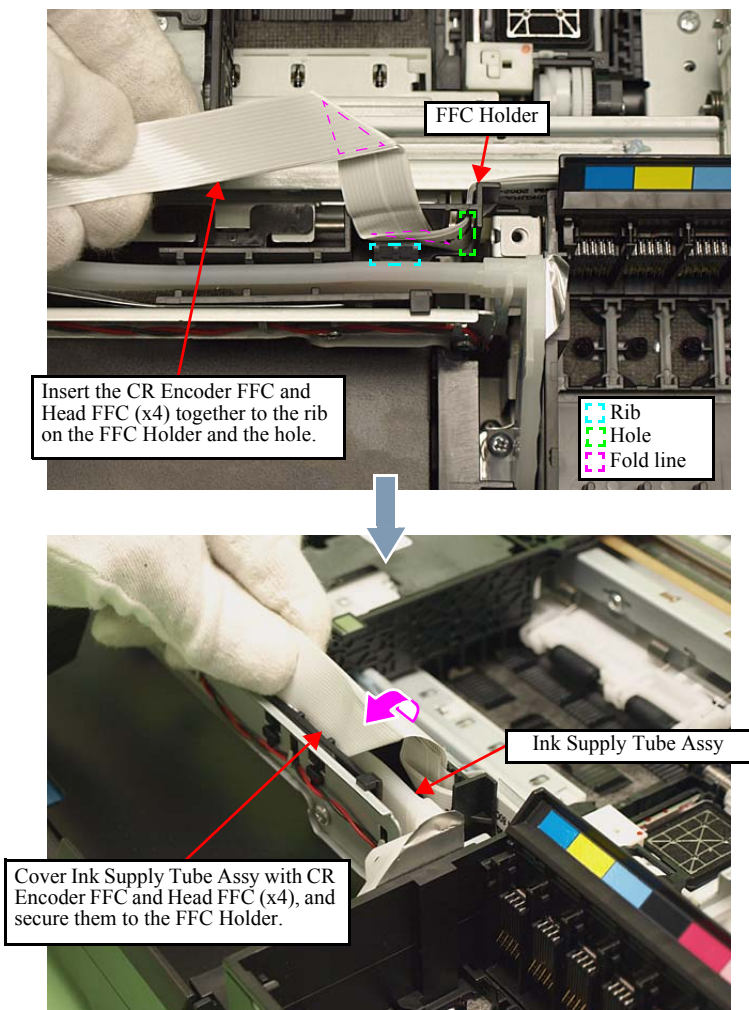


Figure 4-253. Routing to the FFC Holder

ROUTING AROUND THE PRINTER MECHANISM

No.	FFC/cable name	CN No.*	Remarks
1	Plunger cable	CN19	---

Note *: See Fig. 4-245 for the connector positions on the Main Board.

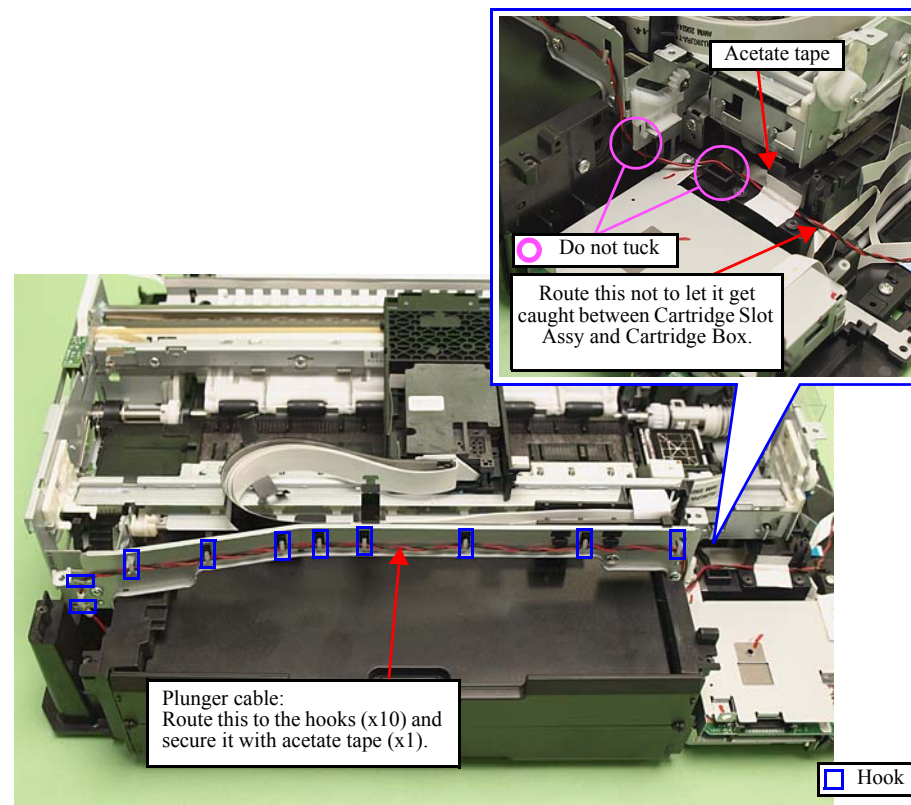


Figure 4-254. Plunger Cable

(Continued to the next page.)

No.	FFC/cable name	CN No.*	Remarks
1	PF Motor Cable	CN22	Ferrite Core x1
2	Power Supply Unit cable	CN501	---

Note *: See Fig. 4-245 for the connector positions on the Main Board.

No.	FFC/cable name	CN No.*	Remarks
1	PE Sensor Cable	CN9	Ferrite Core x1

Note "": See Fig. 4-245 for the connector positions on the Main Board.

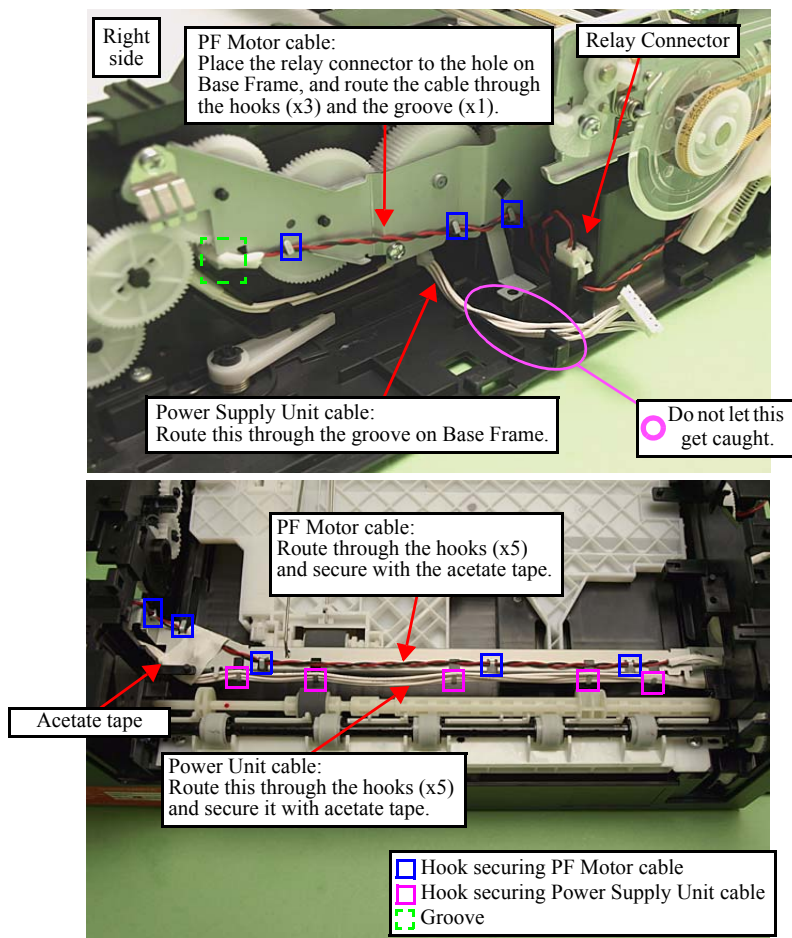


Figure 4-255. PF Motor Cable, Power Supply Unit Cable

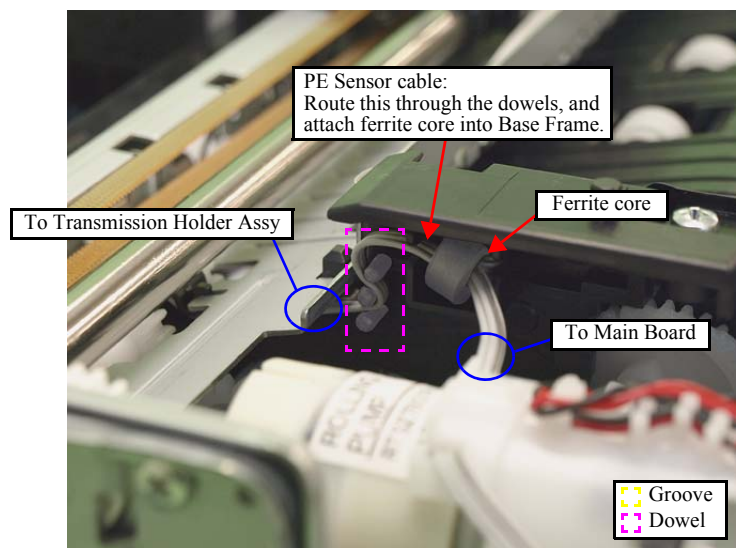
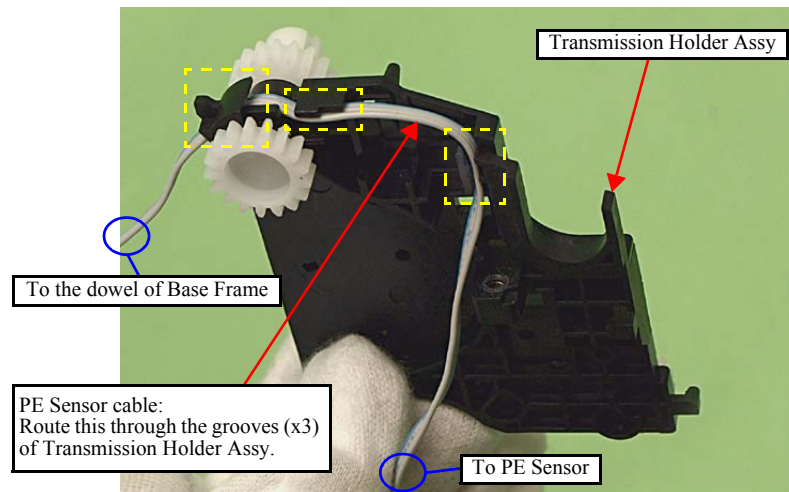


Figure 4-256. PE Sensor Cable

CHAPTER

5

ADJUSTMENT

5.1 Adjustment Items and Overview

This chapter describes adjustments required after the disassembly/reassembly of the printer.

5.1.1 Servicing Adjustment Item List

The adjustment items of this product are shown below.



- For information on how to carry out the adjustments and media required for the adjustments, see the instructions displayed by the adjustment program.
- To avoid the auto head cleaning by the AID function while carrying out each adjustment, you can turn off the auto head cleaning by operating the LCD Panel as follows.
 1. Turn on the printer.
 2. Select “Setup” - “maintenance” - “Automatic Head Maintenance” from the menu displayed on the LCD Panel, and change the auto head cleaning setting to OFF.

Table 5-1. Adjustment Items

Adjustment Item		Purpose	Method Outline	Tool
Adjustment Items	PG Adjustment	Install the Head Nozzle surface parallel to the printing surface and set the gap between the paper and the Head Nozzle surface to the specified value.	For the adjustment method, see 5.3.1 “PG Adjustment (p235)” . If the position of the notch on the Parallelism Adjustment Busings have not changed, only “ Checking the result of PG adjustment (p239) ” is necessary.	<ul style="list-style-type: none"> • Parallelism adjustment jigs (two types; the one for 0th column side and the one for 80th column side) • Fixtures for precision control • Thickness Gauge 1.15mm, 1.3mm • Phillips screwdriver • Hex wrench
	CR timing belt tension adjustment	This adjustment is made to avoid the idling of the CR motor (fatal error) or breaking of the motor coil or the like due to an abnormal heat.	For the adjustment method, see 5.3.2 “CR Timing Belt Tension Adjustment (p240)” .	<ul style="list-style-type: none"> • Tension gauge • Tweezers • (+) Phillips screwdriver
	PF timing belt tension adjustment	This adjustment is made to avoid the idling of the PF motor (fatal error), breaking of the motor coil due to an abnormal heat, or lost of paper feed accuracy that causes banding on the printout.	For the adjustment method, see 5.3.3 “PF Timing Belt Tension Adjustment (p241)” .	<ul style="list-style-type: none"> • Tension gauge • Tweezers • (+) Phillips screwdriver
	Touch Panel Adjustment (Epson Artisan 800/Epson Stylus Photo PX800FW/TX800FW only)	This adjustment is made to adjust the relative positions between the Touch Panel detection points and displaying positions on the Control Panel.	For the adjustment method, see 5.3.4 “Touch Panel Adjustment (Epson Artisan 800/Epson Stylus Photo PX800FW/TX800FW only) (p242)” .	---

Table 5-1. Adjustment Items

Adjustment Item	Purpose	Method Outline	Tool
EEPROM Data Copy	When the main board needs to be replaced, use this to copy adjustment values stored on the old main board to the new board. If this copy is completed successfully, all the other adjustments required after replacing the main board are no longer necessary.	Readout the EEPROM data from the main board before removing it. Then replace the board with a new one, and load the EEPROM data to the new board.	• Adjustment Program
Initial setting	This must be carried out after replacing the main board to apply settings for the target market, etc. Perform MAC address Setting if necessary.	Enter the product serial number of the printer using the adjustment program, and write the initial setting information onto the Main Board. For the procedure of MAC address setting, see 5.2.6 "MAC Address Setting (p223)" .	• Adjustment Program
PG offset value adjustment	To compensate individual variability of the mechanism, write the PG offset values into EEPROM calculated from the result of PG Adjustment.	For the adjustment method, see 5.2.7 "PG Offset Value Adjustment (p225)" .	• Adjustment Program
Memory card check	To check if the access to memory cards is correctly performed.	Save some images in a CF card, and insert it into the slot to see if it can be correctly read.	• CF card • Some image files
Head ID input	This must be carried out after replacing the Printhead in order to enter the new Printhead ID (Head ID) that reduces variation between Printheads.	Enter the 33-digit head ID written on the QR code label on the Printhead. (Read the QR code label from the top left to the bottom right.) The Characters that can be entered as head ID are as follows. ABCDEFGHIJKLMNPQRSTUVWXYZ0123456789%*+-\$:	• Adjustment Program
Top margin adjustment	This corrects timing of printing in the paper feeding direction.	A top margin adjustment pattern is printed. Examine the printout and carry out the adjustment so that the distance between the paper edges and the printed line falls within 3 +/- 1mm.	• Adjustment Program • Ruler
First dot position adjustment	This corrects left margin of printout. The print start position in the carriage moving direction is corrected by software.	A first dot adjustment pattern is printed. Examine the lines printed near the left edge of the printout and enter the value for the line that is exactly 5 mm away from the left edge.	• Adjustment Program • Ruler
PW adjustment	This adjustment is made to correct the mounting position of the PW Sensor on a software basis to adjust the detection position and Nozzle position dispersion.	A PW adjustment pattern is printed. Examine the printout and enter a value for a line exactly 5mm away from the paper edge for each on the four sides.	• Adjustment Program • Ruler
Head angular adjustment	This must be carried out after replacing the Printhead in order to correct tilt of the Printhead.	A head angular adjustment pattern is printed. Examine the printed lines and enter the value for the most straight lines.	• Adjustment Program
AID inspection	To check if the AID function operates normally.	See 5.2.9 "AID inspection (p229)" for information on how to check.	• Adjustment Program
Bi-D adjustment	To correct print start timing in bi-directional printing to improve the print quality.	A bi-d adjustment pattern is printed. Examine the printout and enter a value for one of the patterns with the least black or white line.	• Adjustment Program

Table 5-1. Adjustment Items

Adjustment Item		Purpose	Method Outline	Tool	
Adjustment Items	PF deterioration offset	Initialize	The PF deterioration offset counter is reset.	Reset the PF deterioration offset counter.	• Adjustment Program
		Max value writing	The maximum PF deterioration offset counter is entered.	Enter the maximum PF deterioration offset counter (10,000).	• Adjustment Program
	CR motor heat protection control	This is used to correct variations of motors characteristics.	Select the part(s) you replaced on the Adjustment Program. The program will automatically enter a proper correction value onto the printer.	• Adjustment Program	
	PF motor heat protection control				
	PF adjustment	This corrects errors in paper feed caused by variation of mechanisms and media characteristics.	A PF adjustment pattern is printed. Examine the printout patterns and select the value for the best pattern. The correction value is registered.	• Adjustment Program	
	BRS Adjustment	This adjustment is made to ensure both high print quality (less banding) and high print speed in the target print mode by carrying out 1-path printing correcting ink drop amount for each raster mode.	Print the adjustment pattern to be scanned by a specified scanner. According to the scanned result, a correction value is automatically calculated and stored into the serial flash ROM on the main board. The correction value is applied when printing in the corresponding mode. For more details, see 5.2.10 "Banding Reduction System (BRS) Adjustment / Paper Feed Amount Profile (PFP) Correction (p230)" .	• Adjustment Program • Specified Scanner • PFP base scale	
	PFP Adjustment	This adjustment is made to ensure both high print quality and high print speed in the target print mode by measuring the paper feed errors at various points and calculating a correction value for each of the points.	Print the adjustment pattern to be scanned by a specified scanner. According to the scanned result, a correction value is automatically calculated and stored into the serial flash ROM on the main board. The correction value is applied when printing in the corresponding mode. For more details, see 5.2.10 "Banding Reduction System (BRS) Adjustment / Paper Feed Amount Profile (PFP) Correction (p230)" .	• Adjustment Program • Specified Scanner • PFP base scale	
	Case open sensor check	To check if the Cover open sensor operates normally.	See 5.2.8 "Case Open Sensor Check (p226)" for information on how to check.	• Adjustment Program • Thickness Gauge 0.9mm, 3.0mm	
Leak check	To check the joint section for leakage when disconnecting the joint between the printhead and the ink tube.	See the video manual; separately distributed, for the details.	• Leak Check jig • Air release jig		

Table 5-2. Maintenance Items

Adjustment Item		Purpose	Method Outline	Tool
Maintenance Items	Head cleaning	Run this cleaning when dots missing is observed on an adjustment pattern printed by the adjustment program.	Perform a head cleaning using the adjustment program, and print a nozzle check pattern to see if all the nozzles fire ink properly.	• Adjustment Program
	I/S Decompress	To minimize the amount of ink spilling when removing the printhead, discharge ink in the ink tube via the Ink System (Cap) out of the printer.	After removing the Waste Ink Tray Assy, select “I/S Decompress” from the menu of the adjustment program, and operate following the instruction of the program. See 5.4.1 “I/S Decompress (p244)”.	• Adjustment Program
	Ink charge	This must be carried out after replacing the Printhead in order to fill ink inside the all nozzles of the new ASP Printhead.	After installing the Waste Ink Tray Assy, perform an ink charge using the adjustment program, and print a nozzle check pattern to see if all the nozzles fire ink properly. The auto cleaning is also settable.	• Adjustment Program
	Consumables maintenance counter	The printer causes a maintenance error when the waste ink pad counter reaches its maximum. Use this to reset the counter after replacing the Waste Ink Pad. If you find the counter is close to the maximum during servicing, carry out the pad replacement and the counter reset to avoid the printer returned from the user due to the maintenance error.	Replace the waste ink pads (Waste Ink Tray Assy/Lower Paper Guide Waste Ink Pad Assy), and reset the counter to the default.	• Adjustment Program
	CD-R Print Counter Clear	Initializes the CD-R print counter when replacing the CDR tray to reset the correction value for the CDR tray’s deterioration applied according to the CD-R print counter.	Initialize the CD-R print counter using the adjustment program.	• Adjustment Program
	AID SHK Error Reset	Resets the AID SHK error counter to confirm the cause is on either of AID board, the printhead or any other part when a fatal error related to AID (AID SHK error) occurs. This cancels the fatal error to specify the error part.	Initialize the AID SHK error counter and troubleshoot the error part. See 5.4.2 “AID SHK Error Reset (p245)”.	• Adjustment Program

Table 5-3. Additional Functions

Adjustment Item		Purpose	Method Outline	Tool	
Additional Functions	Final check pattern print	A4 size	To check if all the adjustments have been properly made.	Select the target menu from the adjustment program and run it.	• Adjustment Program
		US Letter size			
	EEPROM dump	Use this to readout the EEPROM data for analysis.	Read out all the data stored on the EEPROM and save it as a file.	• Adjustment Program	

Table 5-3. Additional Functions

Adjustment Item		Purpose	Method Outline	Tool	
Additional Functions	Printer information check	Manual cleaning counter	Use this to readout information on the printer operations.	Select the desired menu in the adjustment program and run it.	• Adjustment Program
		Ink replacement counter Black S			
		Ink replacement counter Black SS			
		Ink replacement counter Yellow S			
		Ink replacement counter Yellow SS			
		Ink replacement counter Magenta S			
		Ink replacement counter Magenta SS			
		Ink replacement counter Cyan S			
		Ink replacement counter Cyan SS			
		Ink replacement counter Light Magenta S			
		Ink replacement counter Light Magenta SS			
		Ink replacement counter Light Cyan S			
		Ink replacement counter Light Cyan SS			
		Total AID counter			
		AID detection counter			
		AID latest code counter			
		ACL failed counter			
I/C latest error code (Black)					

Table 5-3. Additional Functions

Adjustment Item		Purpose	Method Outline	Tool	
Additional Functions	Printer information check	I/C latest error code (Cyan)	Use this to readout information on the printer operations.	Select the desired menu in the adjustment program and run it.	• Adjustment Program
		I/C latest error code (Magenta)			
		I/C latest error code (Yellow)			
		I/C latest error code (Light Cyan)			
		I/C latest error code (Light Magenta)			
		Total print pass counter			
		Total print page counter			
		Total print page counter (Duplex)			
		Total CD-R print counter			
		Total CDR tray open/close counter			
		1st TI received time			
		Latest fatal error code			
		Latest fatal error code 2			
		Scanner fatal error code			
ROM Version					

5.1.2 Required Adjustments

The table below lists the required adjustments depending upon the parts being repaired or replaced. Find the part(s) you removed or replaced, and check which adjustment(s) must be carried out.

Note : <Meaning of the marks in the table>

“O” indicates that the adjustment must be carried out. “O*” indicates that the adjustment is recommended. “---” indicates that the adjustment is not required.

If you have removed or replaced multiple parts, make sure to check the required adjustments for the all parts. And when multiple adjustments must be carried out, be sure to carry out them in the order given in the “Priority” row.

Note *1: “I/S Decompress” is carried out before disassembling. Those with priority 2 or lower are performed after appropriate removal/replacement. (See 4.2.4.1 “Printhead (p124)”.)

*2: Epson Artisan 800/Epson Stylus Photo PX800FW/TX800FW only.

*3: Carry out this operation after removing the Waste Ink Tray Assy.

*4: Carry out "Checking the result of PG adjustment (p239)" only, if the position of the notch on the Parallelism Adjustment Busing have not changed.



- When the EEPROM Data Copy cannot be made for the main board that needs to be replaced, the Waste Ink Tray Assy, the Lower Paper Guide Waste Ink Pad Assy and CDR Tray Assy must be replaced after replacing the main board with a new one.
- After all required adjustments are completed, use the “Final check pattern print” function to print all adjustment patterns for final check. If you find a problem with the printout patterns, carry out the adjustment again.
- When using a new main board for replacing the Printer Mechanism, the Initial setting must have been made to the main board.

Table 5-4. Required Adjustment List

Priority		1	2	3	4	5	6	7	8	9	10	11	12	13	14	15	16	17	18	19	20	21	22	23	24	25	26	27	28	29	
Part Name	Adjustment Item	I/S Decompress*1 *3	Leak Check	PG Adjustment	CR timing belt tension adjustment	PF timing belt tension adjustment	Touch Panel Adjustment*2	EEPROM Data Copy	Initial setting/MAC address Setting	PG offset value adjustment	CD-R Print Counter Clear	Memory card check	Consumables maintenance counter	Ink Charge	Head ID input	Top margin adjustment	First dot position adjustment	PW adjustment	Head angular adjustment	AID inspection	Bi-D adjustment	PF deterioration offset (initialize)	PF deterioration offset (Max value writing)	CR motor heat protection control	PF motor heat protection control	PF adjustment	BRS Adjustment	PFP Adjustment	Final check pattern print	Case open sensor check	
	Main board	Remove	---	---	---	---	---	---	---	---	---	---	O	---	---	---	---	---	---	---	---	---	---	---	---	---	---	---	---	---	O
Replace (Read OK)		---	---	---	---	---	---	O	---	---	---	O	---	---	---	---	---	---	---	O	---	---	---	---	---	---	---	---	---	O	O
Replace (Read NG)		---	---	---	---	---	O	---	O	O	---	O	O	---	O	O	O	O	O	O	O	---	O	O	O	O	O	O	O	O	O
Panel Unit <small>(Epson Artisan 800/Epson Stylus Photo PX800FW/TX800FW Only)</small>	Remove	---	---	---	---	---	---	---	---	---	---	---	---	---	---	---	---	---	---	---	---	---	---	---	---	---	---	---	---	O	O
	Replace	---	---	---	---	---	O	---	---	---	---	---	---	---	---	---	---	---	---	---	---	---	---	---	---	---	---	---	---	O	O
Printhead	Remove	O	---	O*4	---	---	---	---	---	---	---	---	---	O	---	O	O	---	O	O	O	---	---	---	---	O	---	O	O	O	
	Replace	O	O	O*4	---	---	---	---	---	---	---	---	---	O	O	O	O	---	O	O	O	---	---	---	---	O	O	O	O	O	

Table 5-4. Required Adjustment List

Priority		1	2	3	4	5	6	7	8	9	10	11	12	13	14	15	16	17	18	19	20	21	22	23	24	25	26	27	28	29	
Adjustment Item	Part Name	I/S Decompress*1*3	Leak Check	PG Adjustment	CR timing belt tension adjustment	PF timing belt tension adjustment	Touch Panel Adjustment*2	EEPROM Data Copy	Initial setting/MAC address Setting	PG offset value adjustment	CD-R Print Counter Clear	Memory card check	Consumables maintenance counter	Ink Charge	Head ID input	Top margin adjustment	First dot position adjustment	PW adjustment	Head angular adjustment	AID inspection	Bi-D adjustment	PF deterioration offset (initialize)	PF deterioration offset (Max value writing)	CR motor heat protection control	PF motor heat protection control	PF adjustment	BRS Adjustment	PPP Adjustment	Final check pattern print	Case open sensor check	
		Ink Supply IC Holder Assy	Remove	0	---	---	---	---	---	---	---	---	---	---	---	0	---	---	---	---	---	---	---	---	---	---	---	---	---	---	0
	Replace	0	0	---	---	---	---	---	---	---	---	---	---	0	---	---	---	---	---	---	---	---	---	---	---	---	---	---	0	0	
Card Slot Assy	Remove	---	---	---	---	---	---	---	---	---	---	---	---	---	---	---	---	---	---	0	---	---	---	---	---	---	---	---	0	0	
	Replace	---	---	---	---	---	---	---	---	---	0	---	---	---	---	---	---	---	---	0	---	---	---	---	---	---	---	---	0	0	
Power Supply Unit	Remove	---	---	---	---	---	---	---	---	---	---	---	---	---	---	---	---	---	---	---	---	---	---	---	---	---	---	---	0	0	
	Replace	---	---	---	---	---	---	---	---	---	---	---	---	---	---	---	---	---	---	---	---	---	---	0	0	---	---	---	0	0	
CR Motor	Remove	---	---	---	0	---	---	---	---	---	---	---	---	---	---	---	0	---	---	---	0	---	---	---	---	---	---	---	0	0	
	Replace	---	---	---	0	---	---	---	---	---	---	---	---	---	---	---	0	0	---	---	0	---	---	0	---	---	---	---	0	0	
PF Motor	Remove	---	---	---	---	0	---	---	---	---	---	---	---	---	---	---	---	---	---	---	---	---	---	---	---	---	---	0	0	0	
	Replace	---	---	---	---	0	---	---	---	---	---	---	---	---	---	---	0	---	---	---	---	---	---	---	0	0	---	0	0	0	
Carriage Unit	Remove	---	---	0	0	---	---	---	---	0	---	---	---	---	---	0	0	0	0	0	0	---	---	---	---	---	---	0	0	0	
	Replace	---	---	0	0	---	---	---	---	0	---	---	---	---	---	0	0	0	0	0	0	---	---	0	---	---	---	0	0	0	
CDR Tray Assy	Replace	---	---	---	---	---	---	---	---	---	0	---	---	---	---	---	---	---	---	---	---	---	---	---	---	---	---	---	0	0	
EJ Frame Assy	Remove	---	---	---	---	---	---	---	---	---	---	---	---	---	---	---	---	---	---	---	---	---	---	---	---	0	---	0	0	0	
Main Frame	Remove	---	---	0	0	0	---	---	---	0	---	---	---	---	---	0	0	0	0	0	0	---	---	0	0	0	---	0	0	0	
Ink System	Remove	---	---	---	---	---	---	---	---	---	---	---	---	---	---	---	---	---	---	0	---	---	---	---	---	---	---	---	---	0	0
	Replace	---	---	---	---	---	---	---	---	---	---	---	---	---	---	---	---	---	---	0	---	---	---	---	---	---	---	---	---	0	0
Upper Paper Guide L/R	Remove	---	---	---	---	---	---	---	---	---	---	---	---	---	---	0	---	---	---	---	---	---	---	---	---	0	---	0	0	0	
	Replace	---	---	---	---	---	---	---	---	---	---	---	---	---	---	0	---	---	---	---	---	---	---	---	---	0	---	0	0	0	
Waste Ink Tray Assy	Remove	---	---	---	---	---	---	---	---	---	---	---	---	---	---	---	---	---	---	---	---	---	---	---	---	---	---	---	0	0	
	Replace	---	---	---	---	---	---	---	---	---	---	---	0	---	---	---	---	---	---	---	---	---	---	---	---	---	---	---	0	0	
Lower Paper Guide	Remove	---	---	---	---	---	---	---	---	---	---	---	---	---	---	---	---	---	---	---	---	---	---	---	---	---	---	---	0	0	
Waste Ink Pad Assy	Replace	---	---	---	---	---	---	---	---	---	---	---	0	---	---	---	---	---	---	---	---	---	---	---	---	---	---	---	0	0	
Printer Mechanism	Replace	0	0	0	0	0	---	---	---	0	---	0	---	0	---	0	0	0	0	0	0	0	---	0	0	0	---	0	0	0	

Table 5-4. Required Adjustment List

Priority		1	2	3	4	5	6	7	8	9	10	11	12	13	14	15	16	17	18	19	20	21	22	23	24	25	26	27	28	29		
Part Name	Adjustment Item	I/S Decompress*1*3	Leak Check	PG Adjustment	CR timing belt tension adjustment	PF timing belt tension adjustment	Touch Panel Adjustment*2	EEPROM Data Copy	Initial setting/MAC address Setting	PG offset value adjustment	CD-R Print Counter Clear	Memory card check	Consumables maintenance counter	Ink Charge	Head ID input	Top margin adjustment	First dot position adjustment	PW adjustment	Head angular adjustment	AID inspection	Bi-D adjustment	PF deterioration offset (initialize)	PF deterioration offset (Max value writing)	CR motor heat protection control	PF motor heat protection control	PF adjustment	BRS Adjustment	PPP Adjustment	Final check pattern print	Case open sensor check		
	Upper Housing	Remove	---	---	---	---	---	---	---	---	---	---	---	---	---	---	---	---	---	---	---	---	---	---	---	---	---	---	---	---	---	---
Replace		---	---	---	---	---	---	---	---	---	---	---	---	---	---	---	---	---	---	---	---	---	---	---	---	---	---	---	---	---	---	0
Scanner Unit	Remove	---	---	---	---	---	---	---	---	---	---	---	---	---	---	---	---	---	---	---	---	---	---	---	---	---	---	---	---	---	---	0
	Replace	---	---	---	---	---	---	---	---	---	---	---	---	---	---	---	---	---	---	---	---	---	---	---	---	---	---	---	---	---	---	0

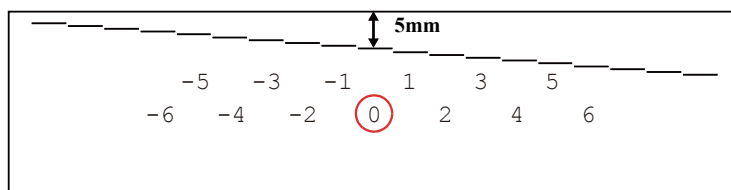
5.2 Adjustment Using Adjustment Program

This section explains how to judge print samples using the adjustment program. Follow the instructions of the adjustment program for details of the adjustment methods.

5.2.1 Top Margin Adjustment

Patterns are printed as shown below.

Top margin printout pattern



Bottom margin printout pattern

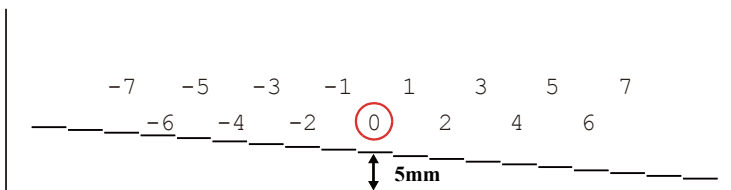


Figure 5-1. Top Margin Adjustment Pattern

How to Judge

Measure the distance from the paper edge to the printed line. Enter the value for the line that is exactly 5 mm away from the edge.

5.2.2 Bi-D Adjustment

The pattern shown below is printed for each of the PG settings and four print modes.



Figure 5-2. Bi-D Adjustment Pattern

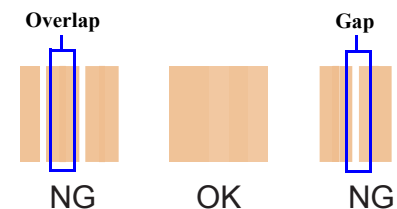
How to Judge

Find the pattern with no gaps or overlaps of the left and right pattern, and enter the value of that pattern.

Additional information

If an appropriate pattern is not printed, enter the nearest value and then print the patterns again.

Example for judgement



5.2.3 PW Adjustment/First Dot Position Adjustment

Patterns are printed as shown below.

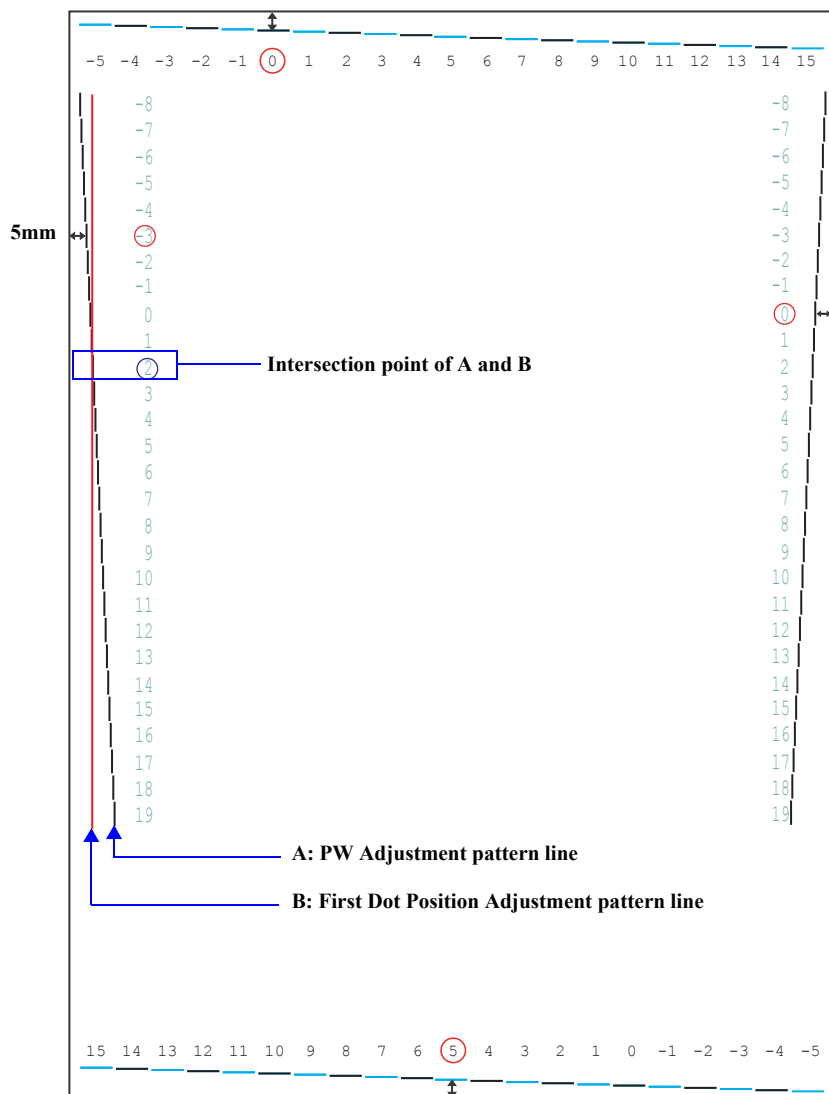


Figure 5-3. PW Adjustment Pattern/First Dot Position Adjustment Pattern

PW Adjustment

How to Judge

Enter the value of the line located 5mm away from each edge.

Example: In the left figure, enter “0” (top), “5” (bottom), “-3” (left) and “0” (right).

First Dot Position Adjustment

How to Judge

Enter the value of the point of intersection of the PW Adjustment pattern line and First Dot Position Adjustment pattern line on the left.

Measure the distance from the left edge of the paper to the printed line. Enter the value for the line that is exactly 5 mm away from the edge.

Example: In the left figure, enter “2” since the lines intersect at 2.

5.2.4 Head Angular Adjustment

Two patterns are printed as shown below.

Band pattern

The following pattern is printed. The lines below “1 to 80” are printed while the carriage moves from the home to the other side, and lines below “80 to 1” are printed while the carriage returns to the home.

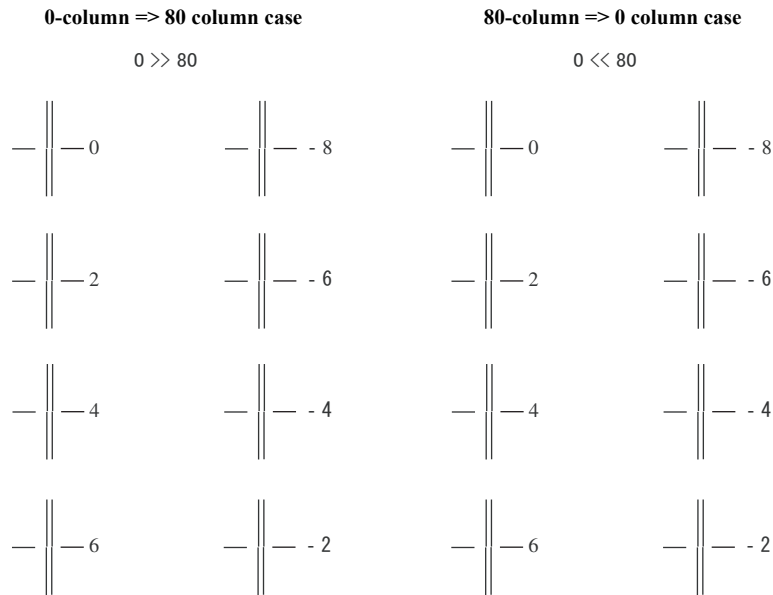


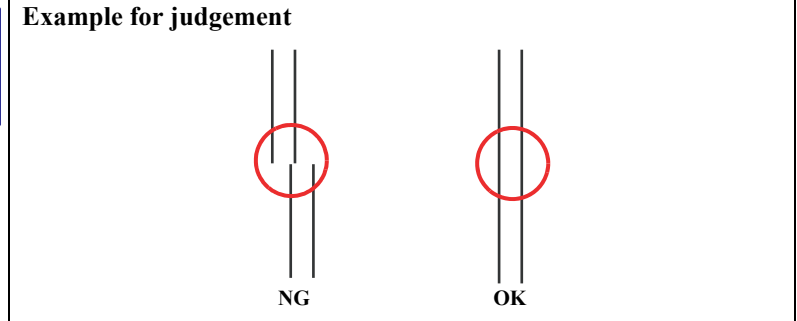
Figure 5-4. Head Angular Adjustment Printout Pattern (1)

How to Judge

Examine the printout patterns for both “0>>80” and “0<<80”, and enter the values of the most straight lines.

Additional information

If the most straight lines are found on the pattern of either end, reassemble the Printhead and carry out this adjustment again.



Microwave Pattern

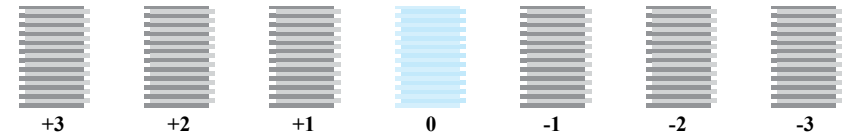


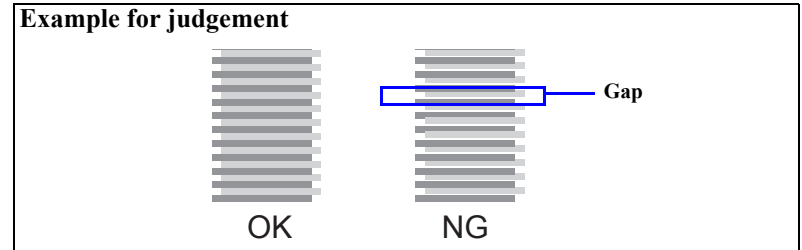
Figure 5-5. Head angular adjustment Pattern Printing (2)

How to Judge

Examine the printout patterns (+2 to -2) and select the value for the group of which the gaps between the 2 color bars are the smallest.

Additional information

If the least gap pattern is found on either end, reassemble/replace the Printhead.



5.2.5 PF Adjustment

□ PF-Standard Area

Patterns are printed as shown below.

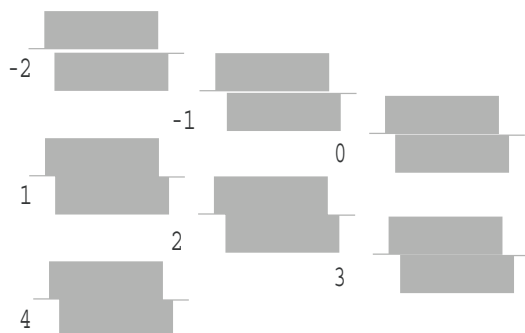
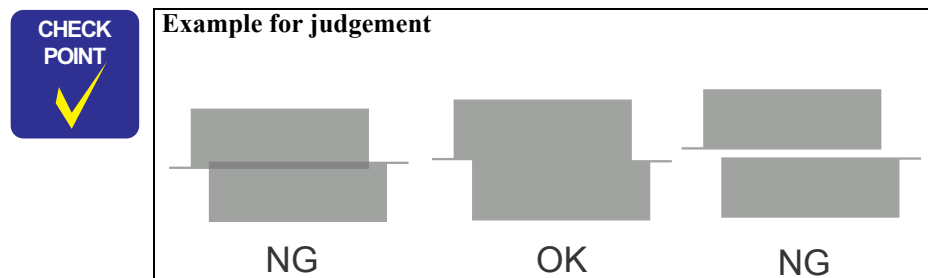


Figure 5-6. PF Adjustment (Standard Area) Pattern

How to Judge

Enter the value for the group that has no gap or overlap between the upper and the lower patterns.



□ PF-Bottom Edge Area

Patterns are printed as shown below.

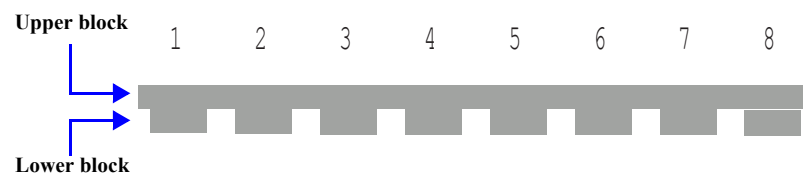


Figure 5-7. PF Adjustment (Bottom Edge Area) Pattern

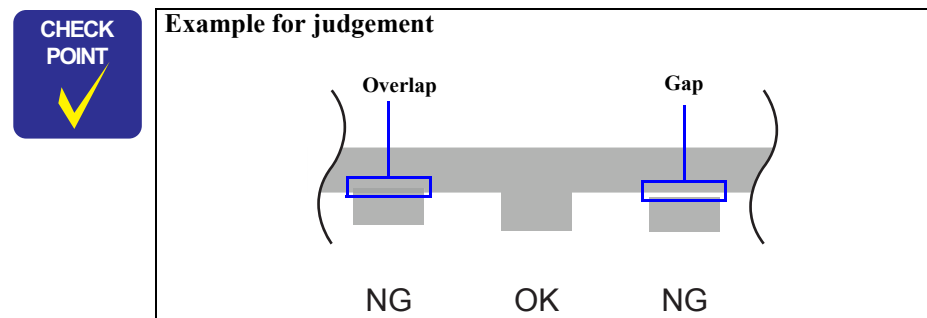
How to Judge

Input the value shown above the patterns which has no gap between the upper pattern and the lower pattern, and also the both upper and lower patterns do not overlap each other.

Example: In the above figure, patterns below “4” has no gap and overlap, so input “4”.

Additional information

In case that all patterns have gap or overlap, select the value for the pattern which has the least gap or overlap, and print the pattern again.



5.2.6 MAC Address Setting

□ Overview

This printer has a network function and stores its MAC address (Media Access Control Address) in the EEPROM on the Network Board. The Network Board supplied as an ASP does not come with the MAC address written on it, therefore, you are required to set the MAC address to the new Network Board after replacement. The following explains the procedure.

CAUTION



- To avoid a conflict of MAC address on a network, make sure to correctly follow the MAC address setting flowchart given on the right.
- The MAC Address is written correctly, The IP Address will be initialized also.
- The user should be notified of the change of MAC address because of the following reasons.
 - If the user has set the printer's MAC address on a router, the repaired printer with a new MAC address cannot be connected to the network.
 - The default printer name on a network consists of "EPSON" and the last six digits of the MAC address. Therefore, the printer name becomes different from the previous one.

□ Preparation

When replacing the Network Board, make sure to note down the MAC address written on a label on the Upper M/B Shield Plate. If the address is not readable due to contamination or any other cause, attach a new MAC address label (part code: 1489231) and note down the new address. See "4.2.3.2 Main Board / Grounding Plate M/B (p117)" for description about the label position.



You are required to enter the last six digits of the MAC address (xx:yy:zz) on the adjustment program.
MAC address example: 00:00:48:xx:yy:zz
(“xx, yy, zz” represents a value unique to each printer)

□ Setting flowchart

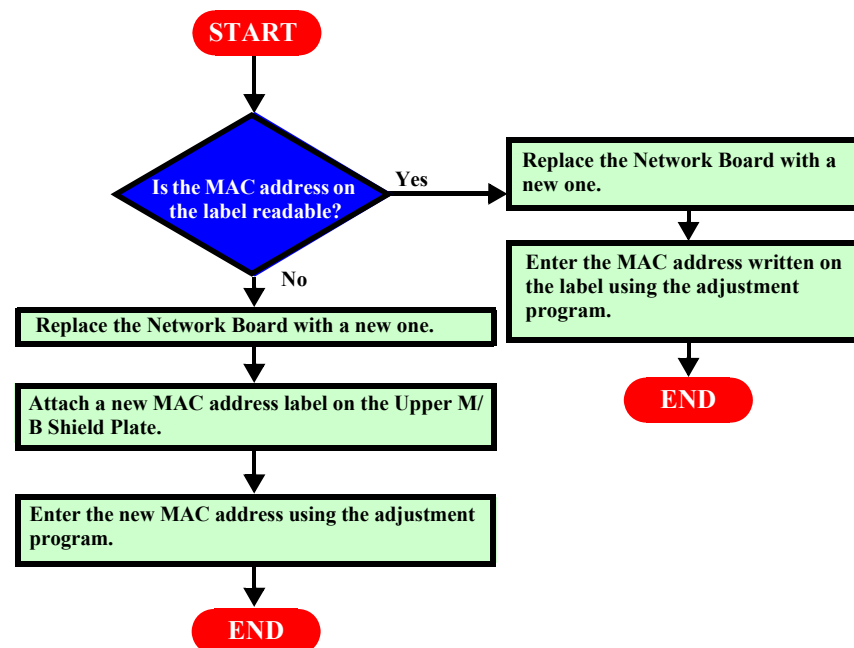


Figure 5-8. MAC Address Setting Flowchart

□ Setting procedure



- The MAC address required on the adjustment program is written on the MAC address label on the Upper M/B Shield Plate. Make sure that the address written on the MAC address label matches the MAC address settings in the EEPROM.

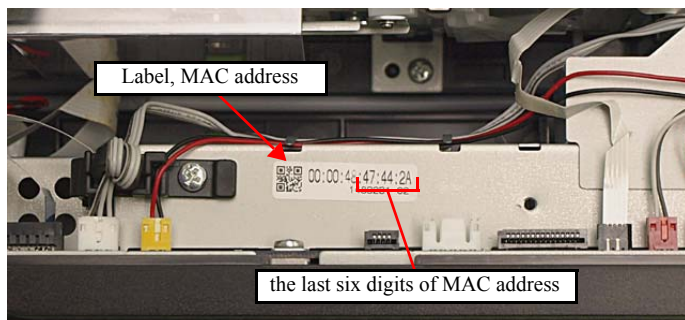


Figure 5-9. MAC Address Label

- Do not use the MAC address of the label attached to the Wireless LAN Board since the address is not used for this product.

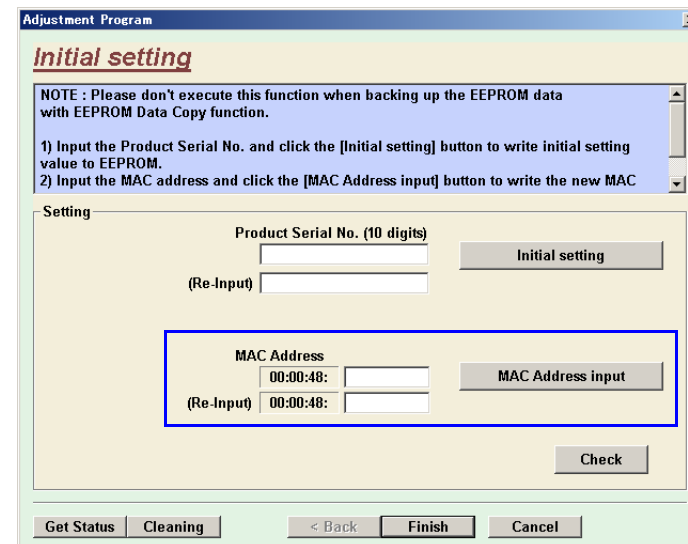


Figure 5-10. MAC Address Setting Screen

1. Start the adjustment program.
2. Select the "Initial Setting" from the menu. The initial setting screen appears.
3. Enter the last six digits of MAC address into the MAC address entry field, and click the MAC Address input button.
(Enter the address again into the second entry field to confirm it.)
4. Select the network status sheet print menu on the printer's control panel, and print the sheet. Check the MAC address printed on the sheet to see if it is correct. refer to [Figure 1-11 "Sample of Network Status Sheet"](#).

5.2.7 PG Offset Value Adjustment

□ Overview

To compensate the deviation of the PG position (see Table 5.3.1 (p235)) derived from the difference of the result of PG Adjustment (p235) due to individual variability of the mechanism, write the notch positions of the parallelism adjustment bushings when PG Adjustment (p235) is performed into EEPROM to correct the PG position during APG operation.

□ Preparation

After PG Adjustment (p235) is complete, check the notch position of the parallelism adjustment bushing at the rear on the 0-column side and note down the offset value according to the figure below.

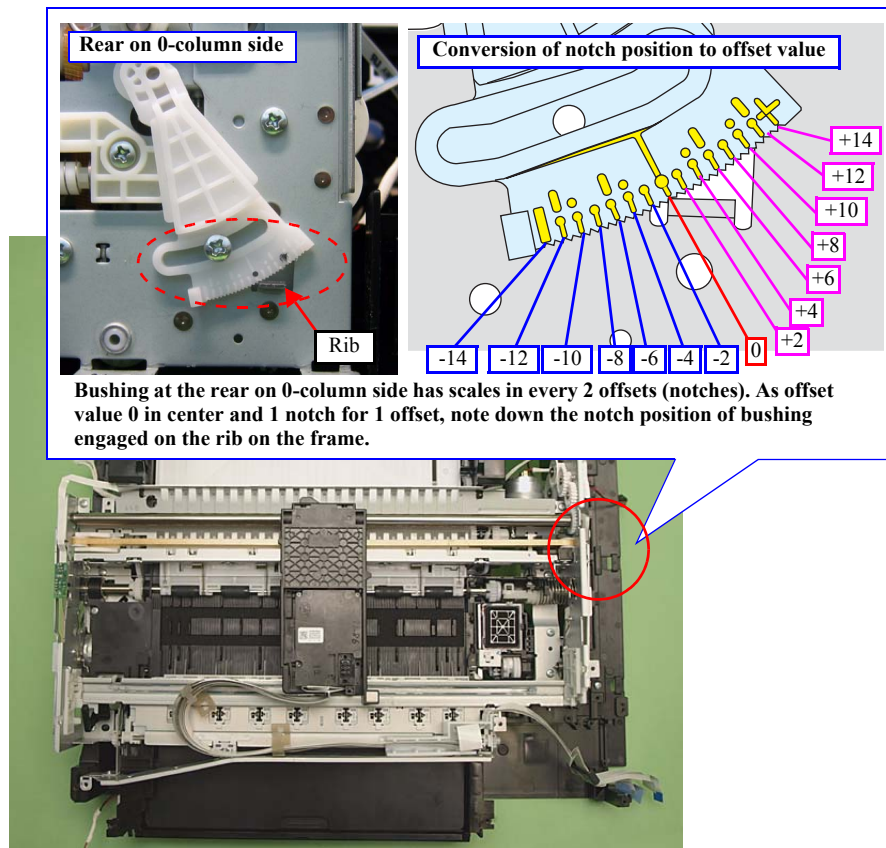


Figure 5-11. Checking the PG Offset

□ Setting procedure

1. Start the adjustment program, and select “PG offset value Adjustment” from the menu.

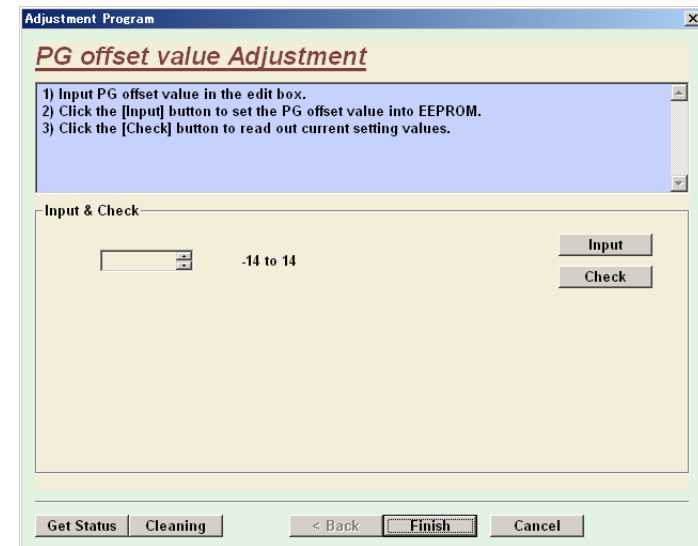


Figure 5-12. PG offset value Adjustment Screen

2. Enter the PG offset value noted down in advance, and press “Input” button.

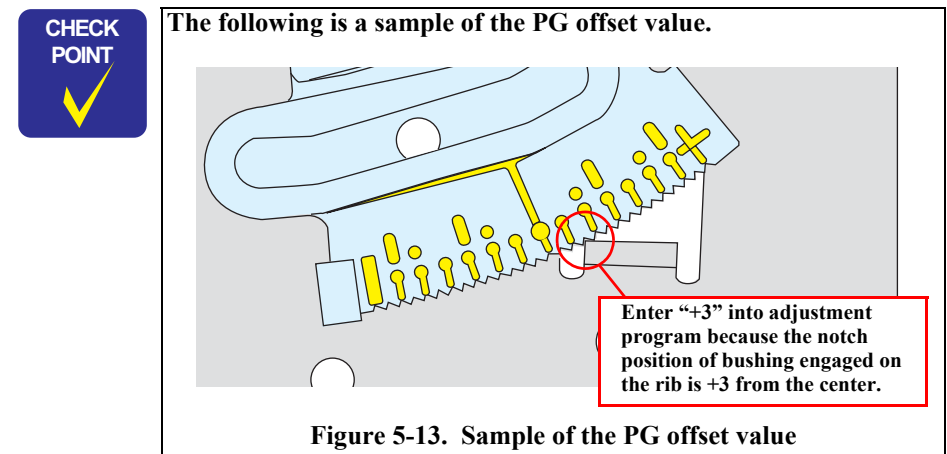


Figure 5-13. Sample of the PG offset value

5.2.8 Case Open Sensor Check

□ Overview

This printer is equipped with a cover open sensor, and a scanner open error occurs when the printer detects the scanner is opened during operation such as printing. This check is to inspect the cover open sensor; which detects open/closed status of the scanner, operates normally.

□ Required tools

- Thickness gauge: 0.9 mm
3.0 mm

□ Checking procedure

Make sure to perform the operation check of the cover open sensor as follows:

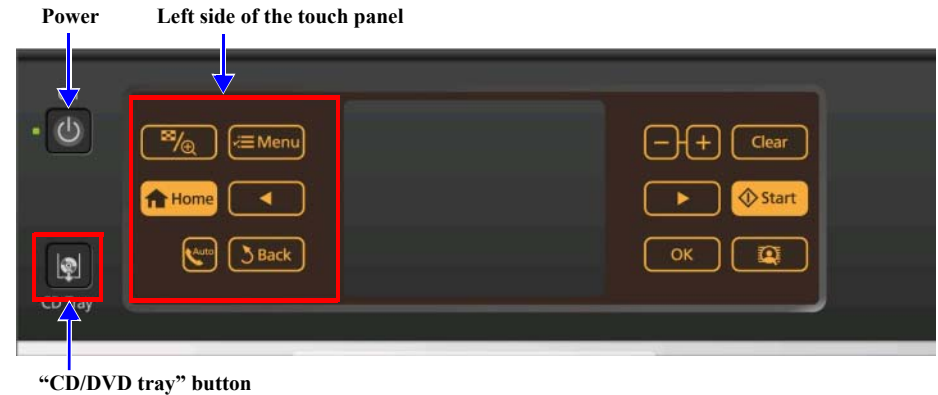


- Make sure to perform the Case open sensor check as described below. Otherwise, it cannot be judged correctly for the sensor to operate normally.
- Do not perform any operation except those described below when checking the cover open sensor. Otherwise, return to Check 1 and perform this check all over again from the start.
- Make sure to perform Check 1 and Check 2 consecutively. Never perform any other operation in between.
- This check must be performed after the printer is completely assembled.

CHECK 1

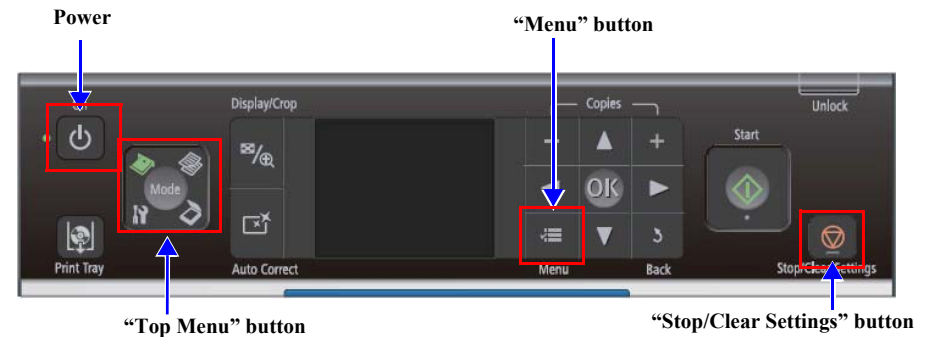
1. Start the printer in the special inspection mode.

- In the case of Epson Artisan 800/Epson Stylus Photo PX800FW/TX800FW
Turn the power on while pressing the panel within the frame on the left side and “CD/DVD Tray” button at the same time for more than three seconds.



**Figure 5-14. Starting the Special Inspection Mode
(Epson Artisan 800/Epson Stylus Photo PX800FW/TX800FW)**

- In the case of Epson Artisan 700/Epson Stylus Photo PX700W/TX700W
Turn the power on while pressing the “Stop/Clear Settings” button, “Menu” button, and “Top Menu” button at the same time for more than three seconds.



**Figure 5-15. Starting the Special Inspection Mode
(Epson Artisan 700/Epson Stylus Photo PX700W/TX700W)**



■ In the case of Epson Artisan 800/Epson Stylus Photo PX800FW/TX800FW, you can operate selection of each menu, etc. by pressing the following areas on the touch panel while in the special inspection mode.

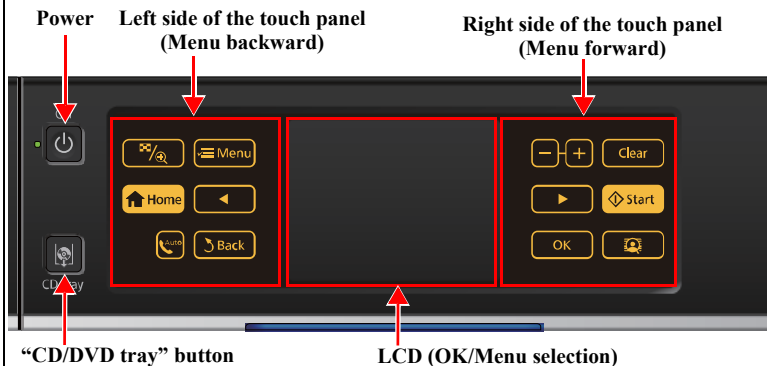


Figure 5-16. Panel Operation in Special Inspection Mode

■ In the case of Epson Artisan 700/Epson Stylus Photo PX700W/TX700W, use the “Cross Key and OK” button for menu selection.

2. Select “Special Inspection”, and press LCD (Epson Artisan 800/Epson Stylus Photo PX800FW/TX800FW) or “Cross Key and OK” button (Epson Artisan 700/Epson Stylus Photo PX700W/TX700W).

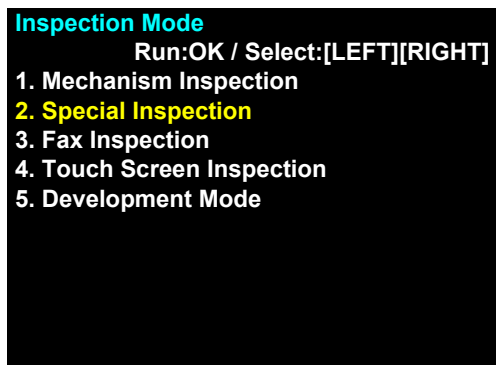


Figure 5-17. Case open sensor check (1)

3. Select “Sensor Check”, and press LCD (Epson Artisan 800/Epson Stylus Photo PX800FW/TX800FW) or “Cross Key and OK” button (Epson Artisan 700/Epson Stylus Photo PX700W/TX700W).



Figure 5-18. Case open sensor check (2)

4. Open the scanner and confirm the Cover open sensor condition changes to “Open!”.

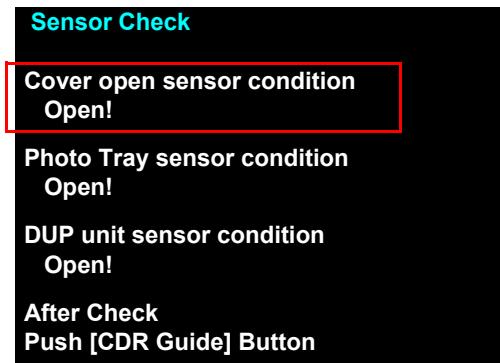


Figure 5-19. Case open sensor check (3)

5. Place the thickness gauge 0.9mm on the location described in *Figure 5-20*.

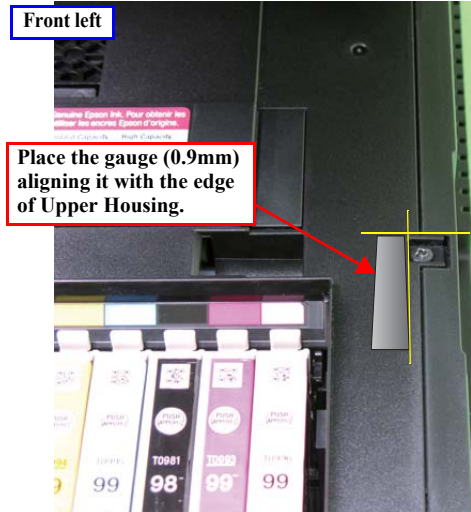


Figure 5-20. Placement of the Thickness Gauge

6. Close the scanner and confirm the Cover open sensor condition changes to “Closed!”.

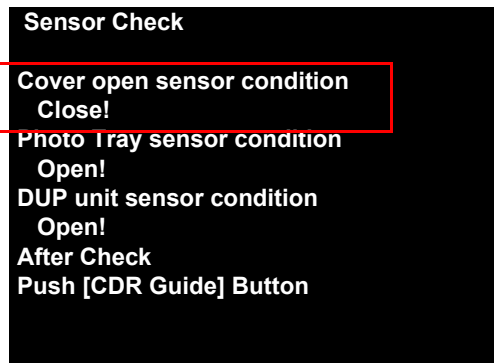


Figure 5-21. Case open sensor check (4)

7. Open the scanner and replace the gauge to the thickness gauge 3 mm, and confirm the Cover open sensor condition changes to “Open!” even when the scanner is closed. (Refer to Figure 5-19.)
8. Press “CD/DVD tray” button to return to “Special Inspection” menu.
9. By pressing the “Power” button, turn off the printer to complete Check 1, and perform *Check 2* (p229) continuously.



If you confirm that the cover open sensor is not operating correctly in *Step 4*, *Step 6*, *Step 7*, check the connection of FFC between the cover open sensor and the Main Board. If the correct connection cannot improve the symptom, replace the scanner unit with a new one.

CHECK 2



- Perform Check 2 at power on immediately after [Check 1 \(p226\)](#).
- Even though the sensor's operation is checked using the adjustment program in Check 2, do not run any other function except the following described in the next procedure until Check 2 is complete.

1. Connect the printer to the computer in which the adjustment program is installed using a USB cable and turn the printer on, then start the adjustment program.
2. Select "Case open sensor check" from "Adjustment" of the adjustment program.
3. Press the "Perform" button on the displayed screen; then the adjustment program automatically checks the cover open sensor.

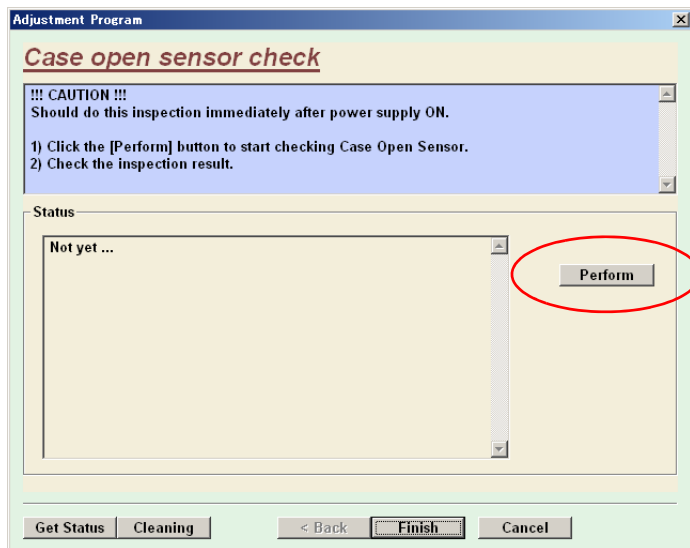


Figure 5-22. Case open sensor check Screen

4. This check is complete if the result is "OK".



If the result is "NG" in [Step 4](#), check the connection of FFC between the cover open sensor and the Main Board. If the correct connection cannot improve the symptom, replace the scanner unit with a new one.

5.2.9 AID inspection

- Overview

The printer has an AID mechanism which automatically carries out nozzle check and runs cleaning according to the number of detected clogged nozzles (AID detection cleaning). This AID inspection check is performed using the all nozzles and inspects the AID function if it works properly or not.

- Preparation

Before starting the AID inspection check, make sure to carry out the following adjustments and check.

- PG adjustment
- Visual check of nozzle check pattern to see if dots are missing.
- Confirm the Waste Ink Tray Assy is installed.



- When you find dot missing on the nozzle check pattern by the visual check, run manual cleanings repeatedly until the check pattern is printed without such symptom.
- When performing the AID inspection, make sure to do it with the Waste Ink Tray Assy installed so as to avoid influence on the electromagnetic noises.

- Procedure

1. Start the adjustment program and select the "AID inspection" from the menu.
2. Click the Perform button to run the AID inspection.
3. Check the inspection result displayed on the adjustment program screen.
4. When the result shows NG, check the following cables to see if they are wrongly connected or broken.
 - Cable connection between the Ink System and the AID Board
 - FFC connecting the Main Board and the AID Board
5. Run the "AID inspection" again. If the result still shows NG, replace the AID Board.

5.2.10 Banding Reduction System (BRS) Adjustment / Paper Feed Amount Profile (PFP) Correction

□ Overview

This section explains how to carry out BRS/PFP adjustments.

CHECK POINT



To calculate the correction value by scanning the printed pattern for BRS/PFP adjustment, be sure to prepare a specified scanner beforehand. Before scanning, confirm that the document table is free from any dirt or stain.

□ Tools and paper required to perform the adjustment

Table 5-5. Tools and Paper for BRS/PFP Adjustment

	Tools/Paper	Product Code
Common	PFP Base scale	1453980
BRS	Matte Paper-Heavyweight (A4)	---
PFP	Premium Glossy Photo Paper (4 x 6)	---

□ Specified Scanner to perform the adjustment



Install the driver of the scanner to the PC in advance.

- As the profile required for the adjustment is not prepared for scanners other than the ones specified below, BRS/PFP Adjustment can not be carried out by the other scanners.

The following are the scanners that can be used for scanning the pattern in BRS/PFP adjustment. When starting up the adjustment program, select the scanner to use.

Table 5-6. Specified Scanner for BRS/PFP Adjustment

Model Name	Sensor type	Remarks
Perfection 4990 Photo	CCD	
Perfection V700 Photo/V750 Pro	CCD	
Epson Stylus Photo RX585/RX595/RX610	CIS	Use the internal scanner.
Epson Artisan 800/Epson Stylus Photo PX800FW/TX800FW	CIS	Use the internal scanner.
Epson Artisan 700/Epson Stylus Photo PX700W/TX700W	CIS	Use the internal scanner.



Depending on the sensor type of the scanner to use for the adjustment, drying time required after the BRS adjustment pattern has been printed differs. For PFP adjustment pattern/PFP check pattern, drying time is not required.

- For “CCD” sensor:
Printed pattern can be scanned straight away. (Drying time of about 2 minutes is recommended.)
- For “CIS” sensor:
Printed pattern needs to be dried more than 5 minutes.

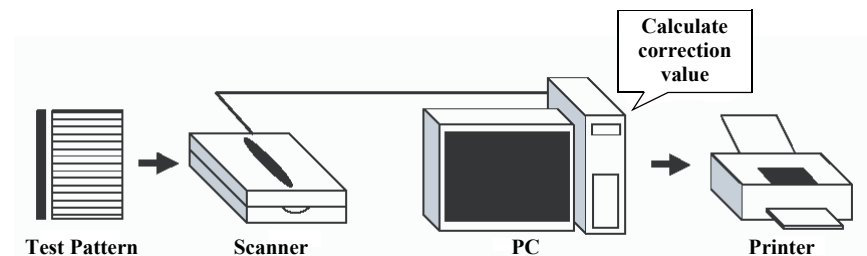


Figure 5-23. System Configuration

□ Adjustment Flow



When performing PFP adjustment only without BRS adjustment, start adjustment from step (2) in *Figure 5-24*.



When an error is displayed in the adjustment program, check the points below, then carry out the adjustment again. If an error occurs even after checking the points below, change the scanner with a different one and carry out the adjustment again.

1. Check that the printer that printed the pattern and the printer to register the adjustment value is the same.
2. Check that the printed pattern is placed on the document table of the scanner correctly.
3. Check that there is no gap between the PFP Base Scale and the pattern printed sheet.
4. Check that the scanner glass surface and the PFP Base Scale is free from any dirt or dust.

Carry out the adjustment following the adjustment flow below.

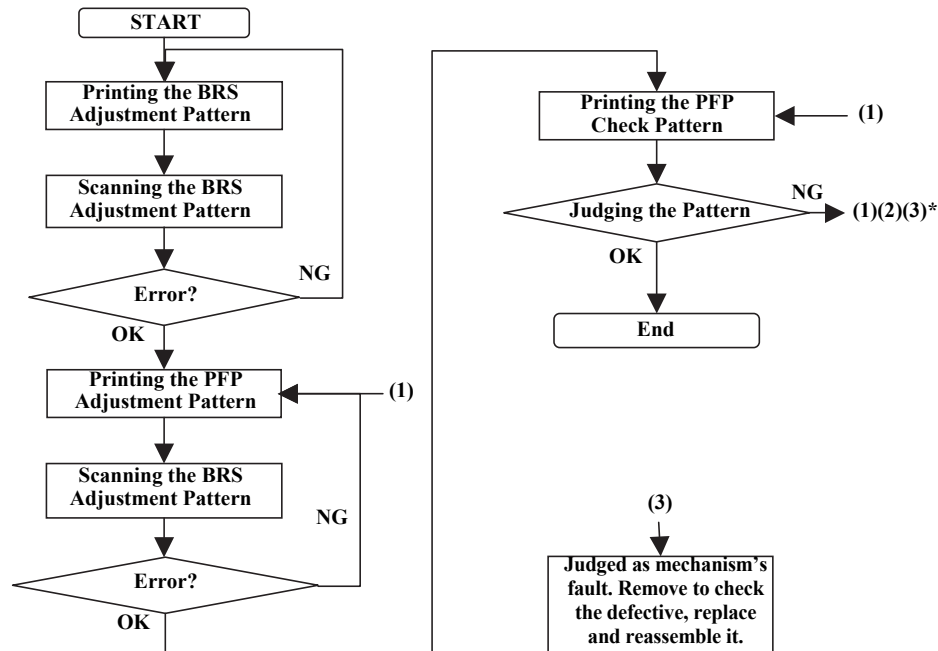


Figure 5-24. BRS/PFP Adjustment Flow

Note*: When a PFP pattern is judged as NG, repeat the steps as described below.

First NG: retry from step (1)

Second NG: retry from step (2)

Third NG: perform step (3)

5.2.10.1 BRS (Banding Reduction System) Adjustment

□ Printing the BRS Adjustment Pattern

1. Load A4 size Matte Paper-Heavyweight on the paper support.
2. Select [BRS Adjustment] in the adjustment program.
3. Click the [Print] button on the “1. Print Test Pattern” column to print the adjustment pattern.
4. Let the printed pattern dry for more than 5 minutes if using CIS sensor type scanner.

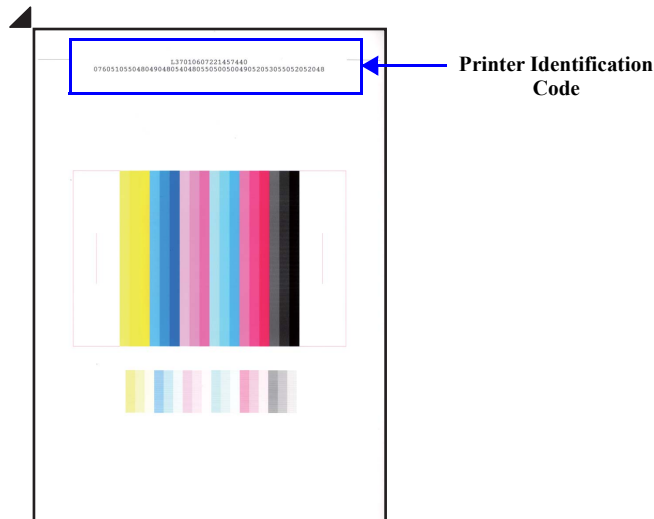


Figure 5-25. BRS Test Pattern

CHECK
POINT



- In the adjustment program, the identification code is used to distinguish whether the printer that printed the pattern and the printer to register the adjustment value is the same.
- Make sure to let the printed pattern dry for more than 5 minutes when using CIS sensor type scanner. When using a CCD sensor type scanner, the printed pattern does not need to be dried before scanning. Refer to “Table 5-6. Specified Scanner for BRS/PFP Adjustment” (p. 230)

□ Scanning the BRS Adjustment Pattern

5. Set the printed pattern and the PFP Base Scale on the document table and click the [Scan] button on the “3. Scan Test Pattern” column.
6. According to the scanned result, BRS calibration values are automatically calculated and are written to the serial flash ROM. If an error occurs, check that the document table glass and the scale is clean, and the scale/adjustment pattern is not tilted, then repeat from step 5.



Be careful of the following when setting the PFP Base Scale, and the adjustment pattern on the scanner.

- Place the scale on the document glass aligning the scale corner with the scanner origin position.
- Place the pattern-printed sheet along the scale as shown in the figure below. Make sure to place it parallel to the scale, with no gaps.

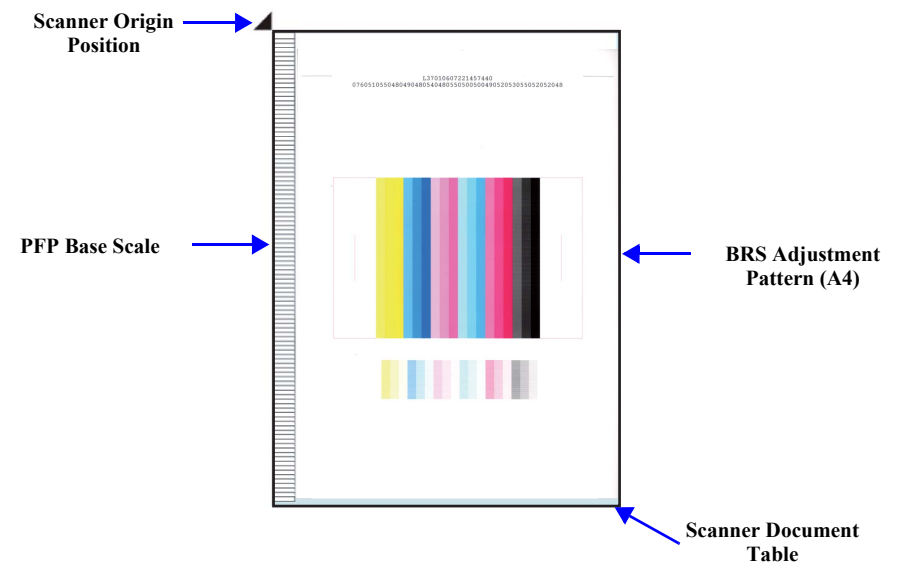


Figure 5-26. PFP Base Scale and BRS Adjustment Pattern Position
(As seen from the document glass of the scanner)

5.2.10.2 PFP Adjustment

□ Printing the PFP Adjustment Pattern

1. Load 4 x 6 Premium Glossy Photo Paper on the paper support.
2. Select [PFP Adjustment] in the adjustment program.
3. Click the [Print] button on the “1. Print Test Pattern” column to print the adjustment pattern.

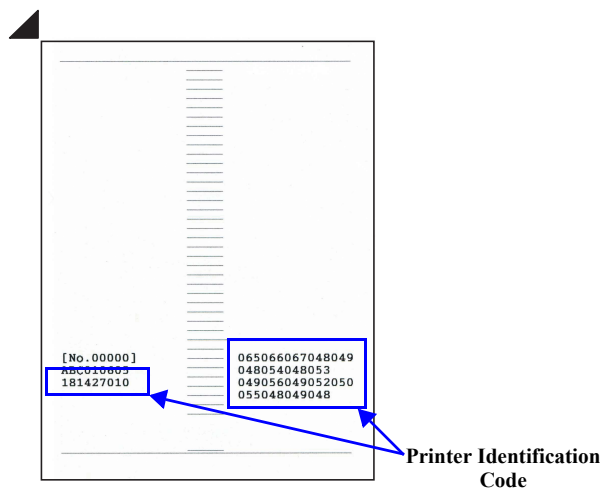


Figure 5-27. PFP Test Pattern

CHECK
POINT

In the adjustment program, the identification code is used to distinguish whether the printer that printed the pattern and the printer to register the adjustment value is the same.

□ Scanning the PFP Adjustment Pattern

4. Set the PFP Base Scale and the PFP test pattern on the document table and click the [Scan] button on the “3. Scan Test Pattern” column.
5. According to the scanned result, PFP calibration values are automatically calculated and are written to the serial flash ROM. If an error occurs, check that the document table glass and the scale is clean, and the scale/adjustment pattern is not tilted, then repeat from step 4.



Be careful of the following when setting the PFP Base Scale and the adjustment pattern on the scanner.

- Place the scale on the document glass aligning the scale corner with the scanner origin position.
- Place the pattern-printed sheet along the scale as shown in the figure below. Make sure to place it parallel to the scale, with no gaps.

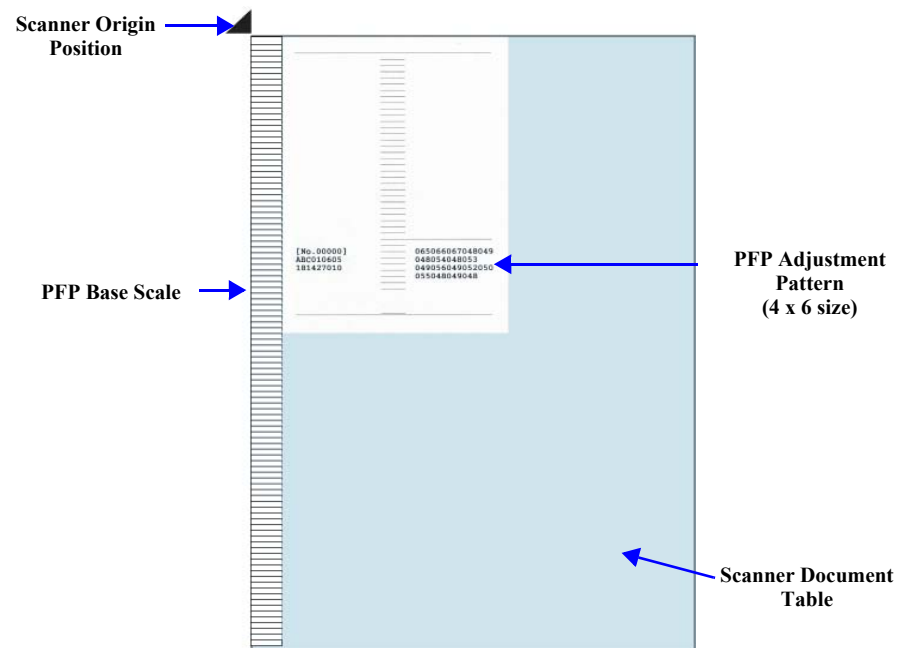


Figure 5-28. PFP Base Scale and PFP Adjustment Pattern Position
(As seen from the document glass of the scanner)

□ Printing the PFP Check Pattern

6. Set 4 x 6 Premium Glossy Photo Paper on the paper support and click the [Print] Button on the “4. Print Check Pattern” column.

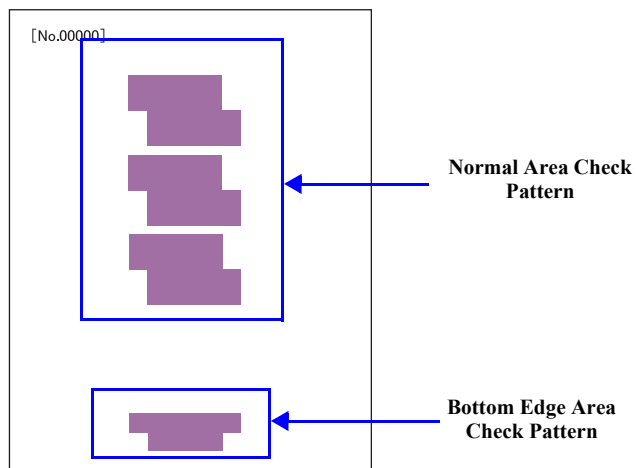


Figure 5-29. PFP Check Pattern

□ Judging the Check Pattern

7. Referring to [Figure 5-30](#) check that there is no white or overlapped bands in all the check patterns. If any bands are found, carry out the steps below.
1. Re-print the check pattern to see if the bands appear again.
 2. When bands appear in Step 1, try the PFP adjustment again from the beginning.
 3. When bands appear even after the re- adjustment in step 2, determine that it is the mechanism failure and carry out check/reassemble of the parts that was removed/replaced.

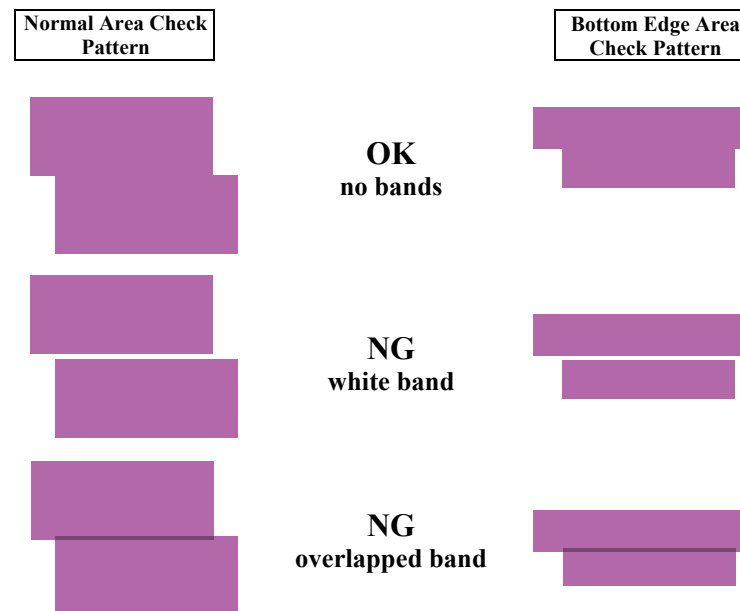


Figure 5-30. PFP Check Pattern Judging Standard

5.3 Adjustment without Using Adjustment Program

This section explains the adjustment procedure without using the adjustment program.

5.3.1 PG Adjustment

Described below is the platen gap (PG) adjustment.

- Purpose:
Adjust the distance between the head surface and the Paper Guide Front Assy (platen) properly and adjust the parallelism on the 0-digit side and on the 80-digit side to ensure reliable print quality.
When the gap to the platen has been changed by adjusting the adjustment bushes as in removing the Carriage unit, make this adjustment to correct the deviation of the platen gap.

Table 5-7. PG Positions

Position	PG Size (mm)	Application for Printing (selected from PG flag list for normal/head rubbing)	Sequence Application
PG- <APG Home>	1.2	EPSON special paper	Applied while capping, wiping operations, during standby after power-on, performing AID adjustment.
PG typ. <Mechanical default>	1.7	Plain paper Select when PG- is too narrow	Applied while capping
PG+	2.35	Envelopes Select when PG typ. is too narrow	Applied while capping
PG++	2.95	CD/DVD	Applied while capping Applied while EJ release operation

- Tools
 - Parallelism adjustment jigs (two types; the one for 0th column side and the one for 80th column side)
 - Fixtures for precision control
 - Thickness gauge: 1.15 mm (x2)
1.3 mm (x2)
 - Phillips screwdriver
 - Hex wrench
- Standard value
 - Specified PG value: 1.2 ± 0.1 mm

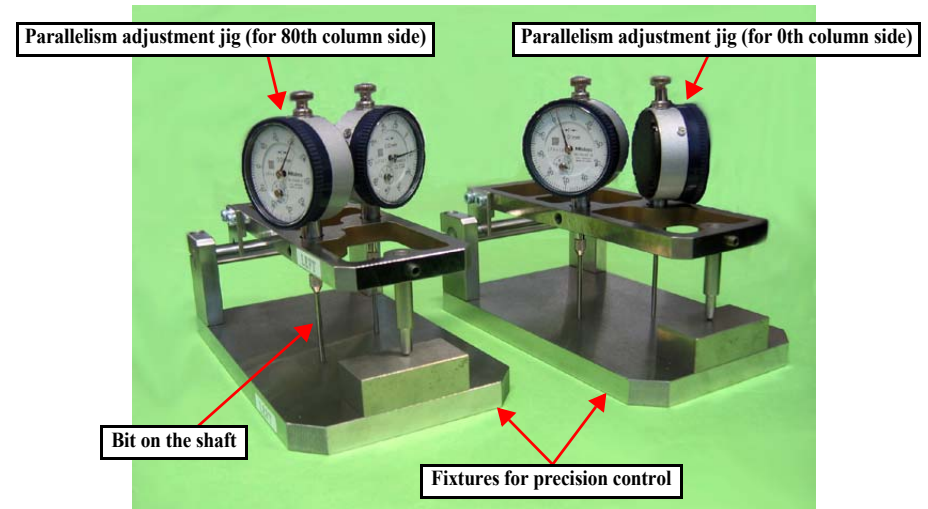


Figure 5-31. Parallelism adjustment jig/Fixtures for precision control



- Handle the jigs with care because the bit on the shaft of dial gauge of parallelism adjustment jigs is very fragile and gets broken easily.
- The thickness gauges to be used must be free from dust and dirt and from deformation. Be sure to clean it before use.
- Take care not to soil or scratch the Printhead.
- Move the carriage right and left by pulling the belt, not by holding down (or pressing) the carriage.



- Carry out this adjustment with installing the Printhead, the Ink Supply Tube Assy and the Cartridge Box Unit. (Install the CR Scale after this adjustment) See “4.2.4 Disassembling the Printer Mechanism (p124)”.
- Epson Artisan 800/Epson Stylus Photo PX800FW/TX800FW/ Epson Artisan 700/Epson Stylus Photo PX700W/TX700W have five PG pre-settings using the APG mechanism. Use the minimum PG setting (PG-: 1.2mm) to carry out this adjustment.
See Figure 5-36.
- Carry out “Checking the result of PG adjustment (p239)” only, if the position of the notch on the Parallelism Adjustment Bushings have not changed.

□ Preparation

■ Preparing the parallelism adjustment jigs

After assembling the parallelism adjustment jigs, check the origin of each dial gauge using the fixtures for precision control, and adjust them if necessary.

1. Attach the bits to the shafts of the dial gauges of parallelism adjustment jig.
2. Place the jigs on the fixtures for precision control.
3. Keeping the jig on the fixture, loosen the screws of the jigs with hex wrench, and adjust the jigs until the values on each dial gauge become those shown in [Figure 5-32](#) by sliding the dial gauge up and down.
4. Turn the scale of the dial gauge A keeping it on the fixture until the value becomes 30.

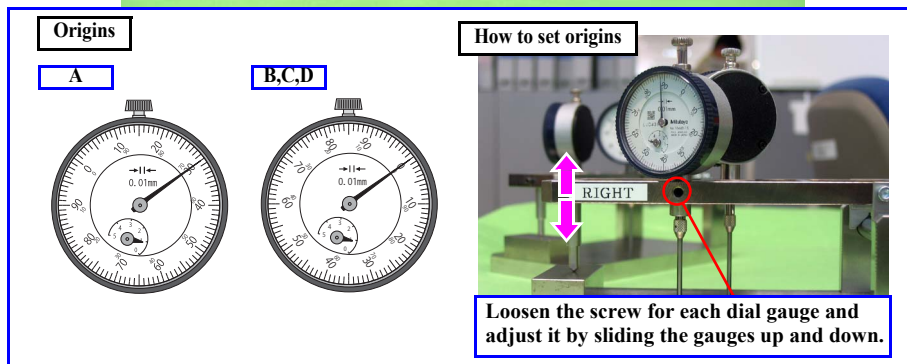
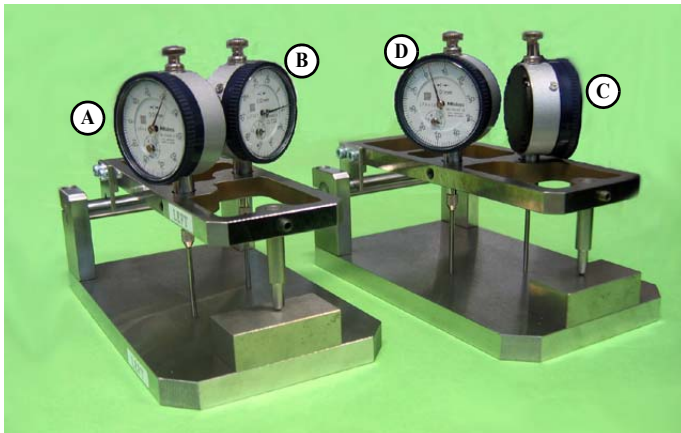


Figure 5-32. Setting the origins of dial gauges

■ Checking the status of printer mechanism

Before starting the PG adjustment, confirm the printer mechanism is in the following status.

- The phases of the spur gear of APG Assy and the Carriage Shaft have been aligned correctly when assembling the carriage.

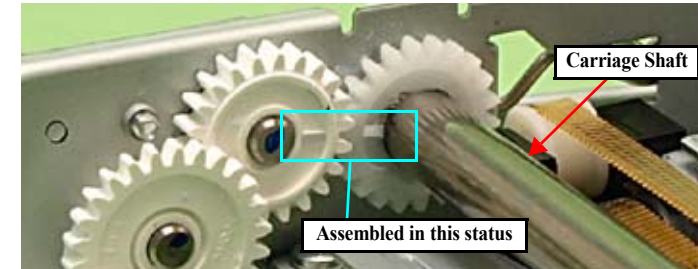


Figure 5-33. Phase of the spur gear of APG Assy

- The centers of parallelism adjustment bushings on the sides of printer mechanism are set on the ribs of the frame.

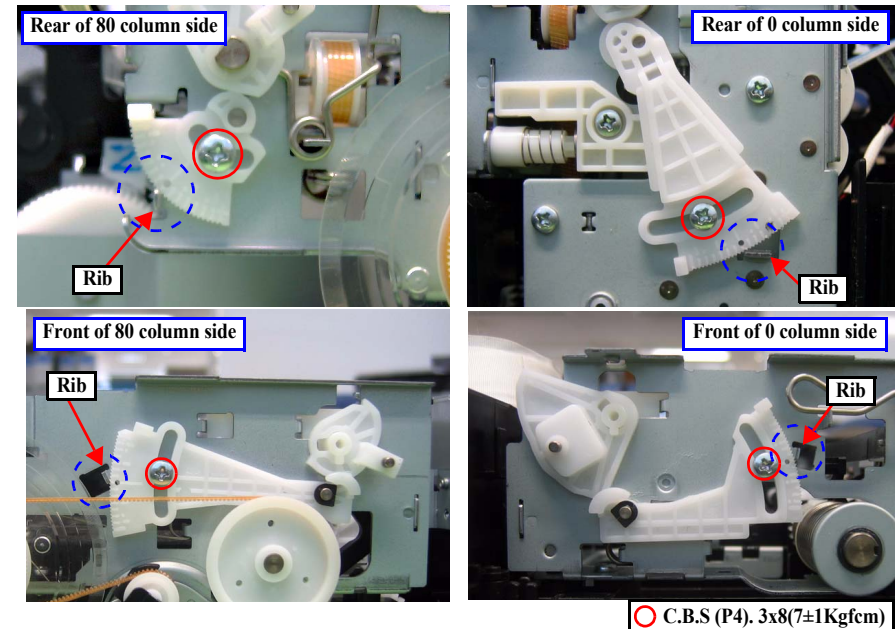


Figure 5-34. Positions of parallelism adjustment bushings

- The EJ Frame Assy must be lowered most.

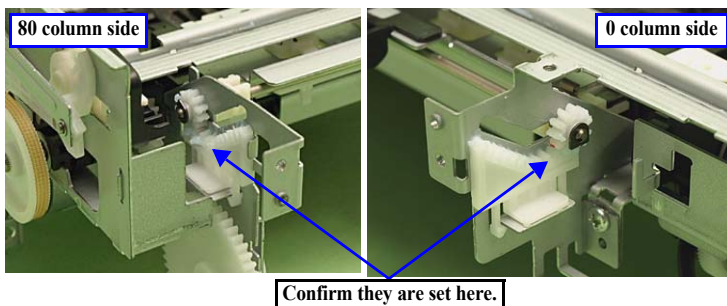


Figure 5-35. Position of EJ Frame Assy

- Check that the PG cams; located on both the left side and the right side of the Carriage Shaft and the CR guide plate, are in the PG-position. (Fig. 5-36)

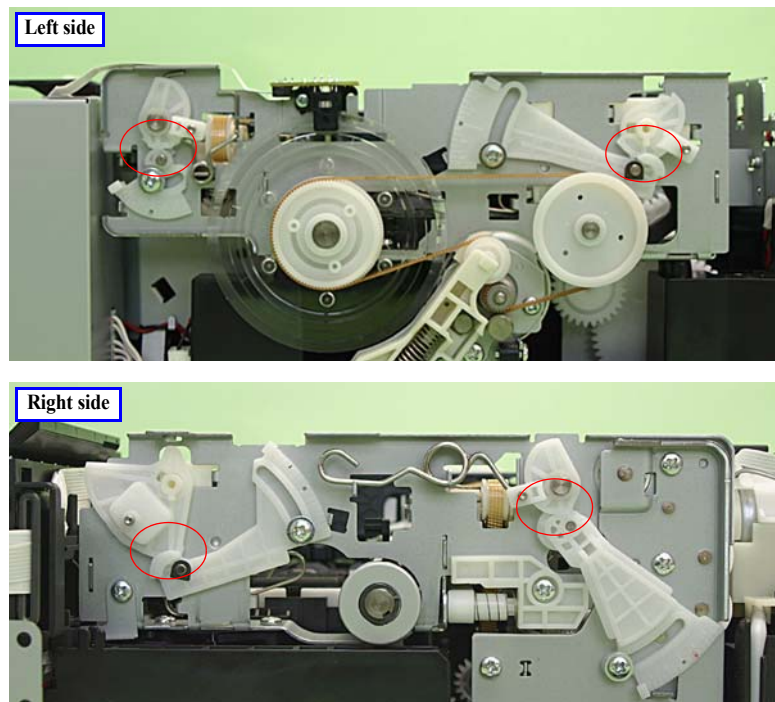


Figure 5-36. PG position when adjusting

- Adjustment procedure

1. Move the carriage to the home position.
2. Loosen all the screws the secure each parallelism adjustment bushing. (Fig. 5-34)
3. Attach the parallelism adjustment jigs to the printer mechanism.

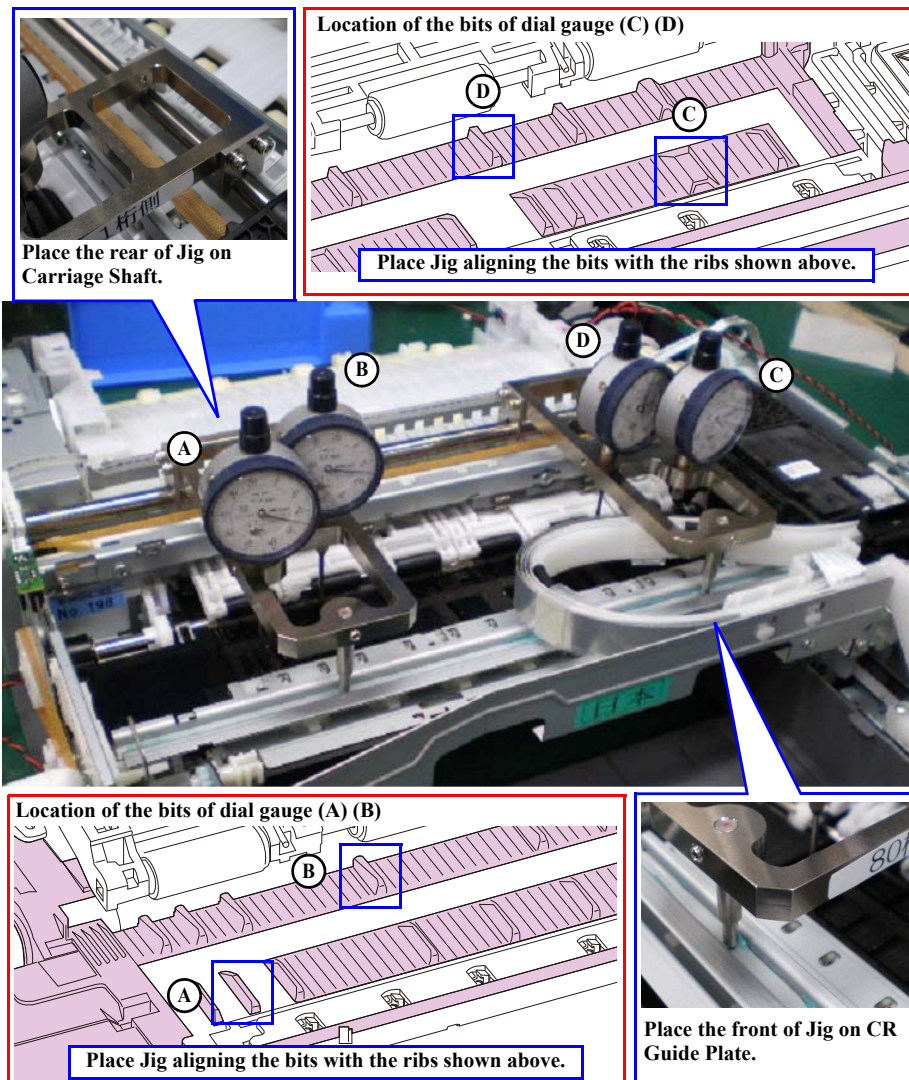
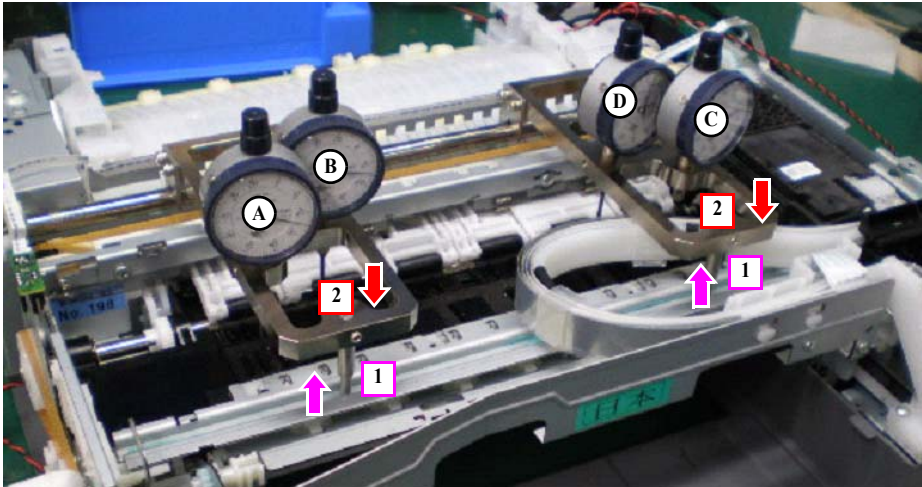


Figure 5-37. Installing the parallelism adjustment jigs

4. To reduce measurement errors, lift and lower each part **1** of the jigs lightly, then press each part **2** easily.
5. Check all the dial gauges, and adjust the parallelism adjustment bushings within the standard values in the order of closest to the dial gauge indicating the biggest value.



Standard value	Each dial gauge must be: within -0.05mm to +0.05mm
	Each gauge's value range (max. to min.) must be within 0.05mm.

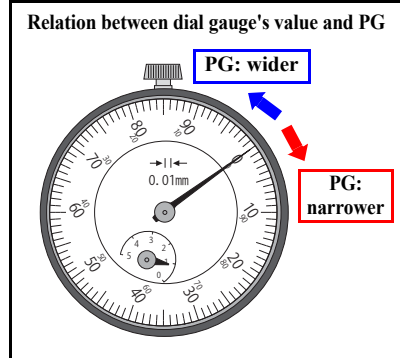


Figure 5-38. PG adjustment

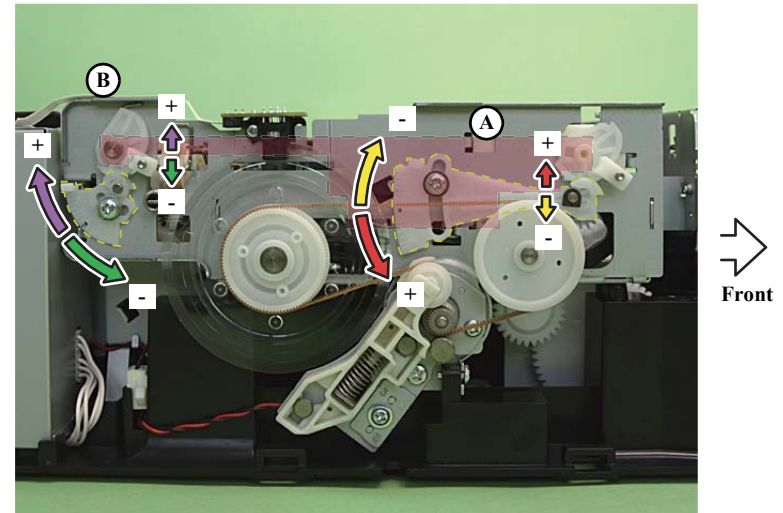


Figure 5-39. Operating the parallelism adjustment bushing (Left side)

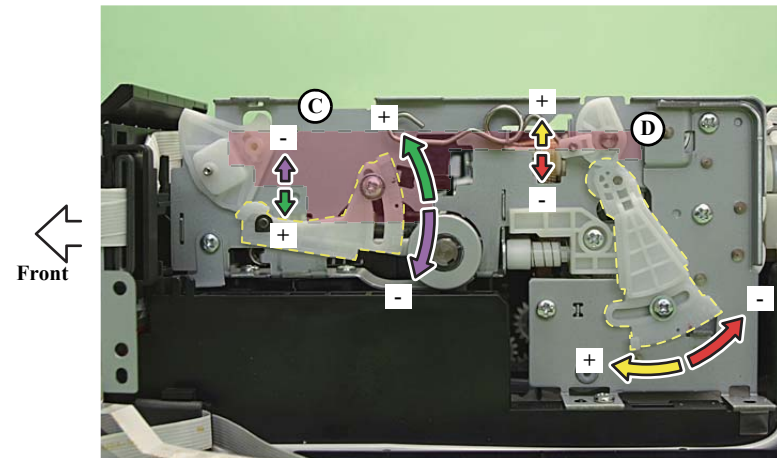


Figure 5-40. Operating the parallelism adjustment bushing (Right side)

6. Tighten the screw of each parallelism adjustment bushing to secure them. (Fig. 5-34)
7. Remove the parallelism adjustment jigs from the printer mechanism.

- Checking the result of PG adjustment

CHECK
POINT



Epson Artisan 800/Epson Stylus Photo PX800FW/TX800FW/Epson Artisan 700/Epson Stylus Photo PX700W/TX700W have five PG pre-settings using the APG mechanism. Use the minimum PG setting (PG-: 1.2mm) to carry out this checking. See [Figure 5-36](#).

1. Move the carriage to the center of the platen, and place one of the 1.1 mm thickness gauges aligning the left edge with the third rib from the left end of the Front Paper Guide to the fifth rib. Then place the other 1.1 mm thickness gauge aligning the right edge with the second rib from the right end of the Front Paper Guide to the fifth rib. (*Fig. 5-41*)

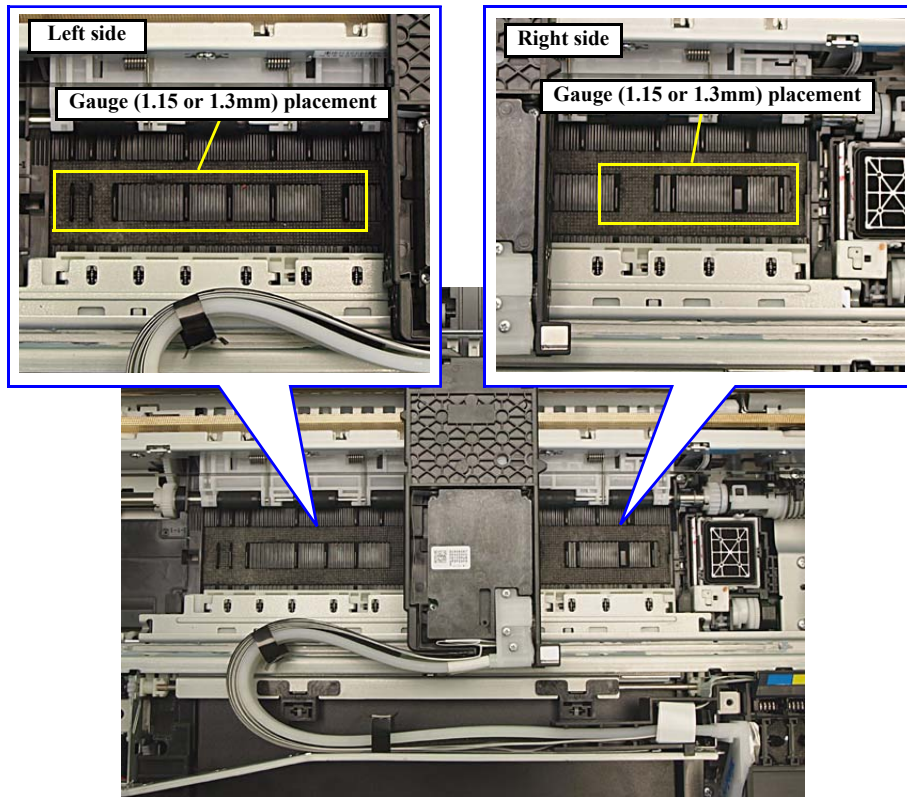


Figure 5-41. Setting the thickness gauge

2. Pull the Timing Belt to move the carriage to both ends and confirm the carriage does not touch the gauges.
3. If the carriage comes in contact with a gauge, perform the adjustment again.
4. Move the carriage to the center of the platen, and place 1.3 mm thickness gauges on the same position in step 1 (instead of 1.15mm ones).
5. Pull the Timing Belt to move the carriage to both ends and confirm the carriage comes in contact with the gauges.
6. If the carriage does not touch the gauges, perform the adjustment again.

5.3.2 CR Timing Belt Tension Adjustment

This section describes CR Timing Belt tension adjustment.

- Purpose

This adjustment is made when the CR Timing Belt is removed, re-installed, or loosened. Confirm that the belt tension is proper when the CR Timing Belt is installed.
- Things to be used
 - Tension gauge
 - Plastic Tweezers
- Standard value
 - $12.7 \pm 1.84\text{N}$
- Adjustment procedure
 1. Set the following parameters to the tension gauge:
 - Weight: 1.0
 - Width: 4.0
 - Span: 310
 2. Bring the microphone closer to the center of the Timing Belt.



Bring the microphone within 5mm from the Timing Belt but do not let it touch the belt.



- Flip the belt as weak as the tension gauge can measure it.
- Be careful not to damage the Timing belt when flipping it with the plastic tweezers.
- Be careful not to let the microphone touch the Timing Belt when flipping the belt.

3. Press the “MEASURE” button on the Tension gauge and flip the Timing Belt with plastic tweezers.
4. Repeat the steps three times and confirm that the measured values are within the standard. If not, replace the Mechanism Unit.

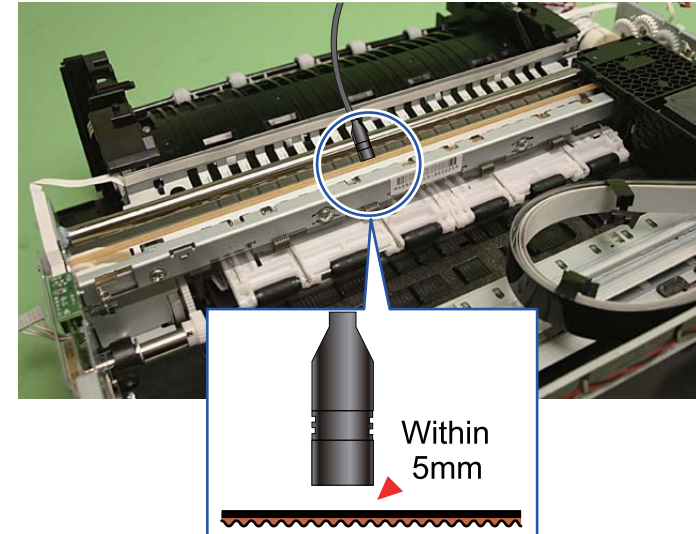


Figure 5-42. Preparation

5.3.3 PF Timing Belt Tension Adjustment

This section describes PF Timing Belt tension adjustment.

- Purpose

This adjustment is made when the PF Timing Belt is removed, re-installed, or loosened. Confirm that the belt tension is proper when the PF Timing Belt is installed.
- Things to be used
 - Tension gauge
 - Plastic Tweezers
- Standard value
 - $7 \pm 1\text{N}$
- Adjustment procedure
 1. Move the carriage to the home position.
 2. Set the following parameters to the tension gauge:
 - Weight: 0.9
 - Width: 3.0
 - Span: 73
 3. Bring the microphone closer to the center of the Timing Belt. (See [Figure 5-43 \(p.241\)](#))
 4. Press the “MEASURE” button on the Tension gauge and flip the Timing Belt with plastic tweezers.

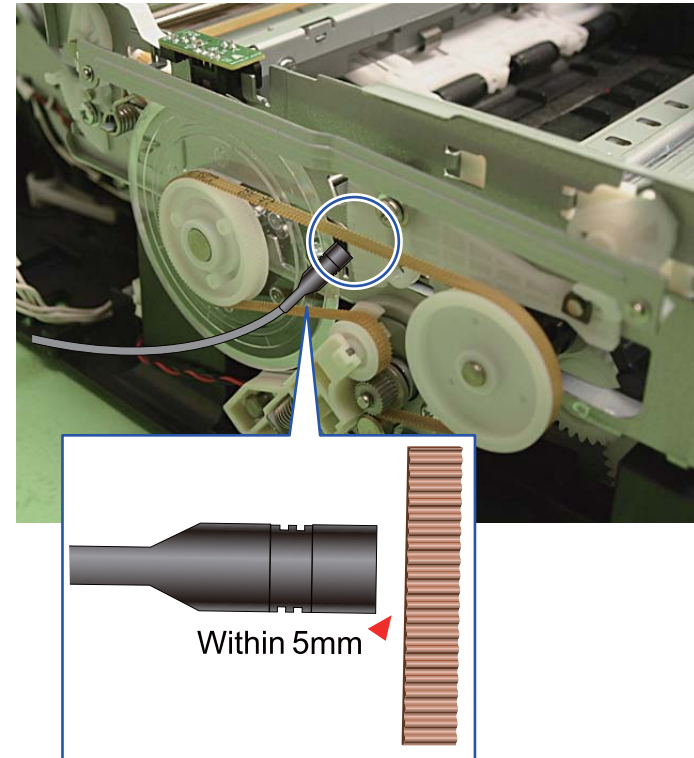


Figure 5-43. Preparation

5. Repeat the steps three times and make sure all the measured values are within the standard. If not, turn the Spacer around or over so that another letter (2, 4, or 1) comes to the upper left, and carry out the measurement again. (See “4.2.4.14 PF Motor” (p.150))

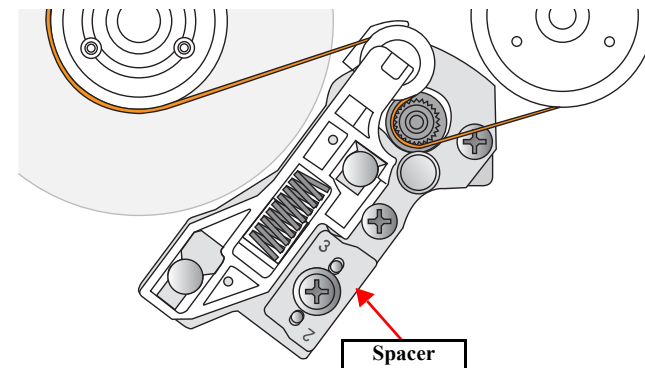


Figure 5-44. Spacer

CHECK
POINT



Bring the microphone within 5mm from the Timing Belt but do not let it touch the belt.

CAUTION



- Flip the belt as weak as the tension gauge can measure it.
- Be careful not to damage the Timing belt when flipping it with the plastic tweezers.
- Be careful not to let the microphone touch the Timing Belt when flipping the belt.

5.3.4 Touch Panel Adjustment (Epson Artisan 800/Epson Stylus Photo PX800FW/TX800FW only)

This section describes Touch Panel adjustment.

- Purpose
This adjustment is made to adjust the relative positions between the Touch Panel detection points and displaying positions on the Control Panel.
- Things to be used
Touch pen (without a sharp end such as a plastic stick)
- Adjustment procedure

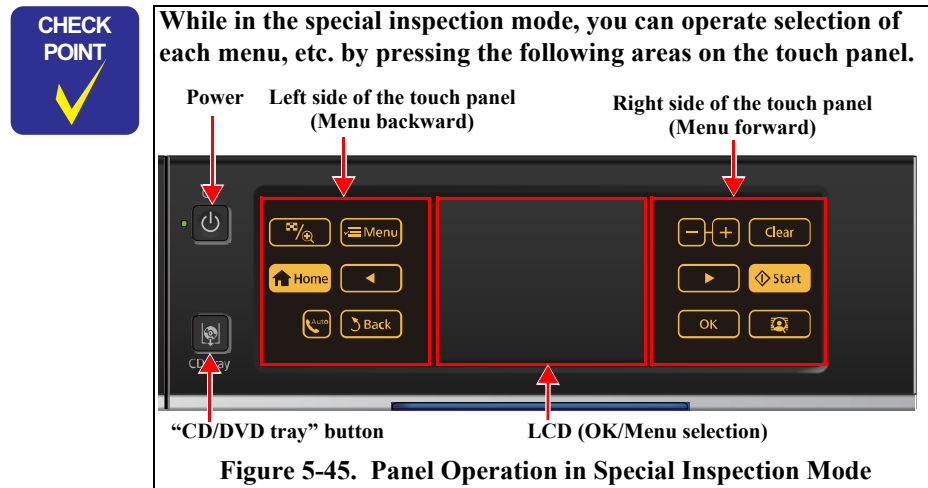


Figure 5-45. Panel Operation in Special Inspection Mode

1. Turn on the printer in the special inspection mode. (See 5.2.8 Case Open Sensor Check Step1 (p226).)
2. Select “Touch Screen Inspection” and press LCD.

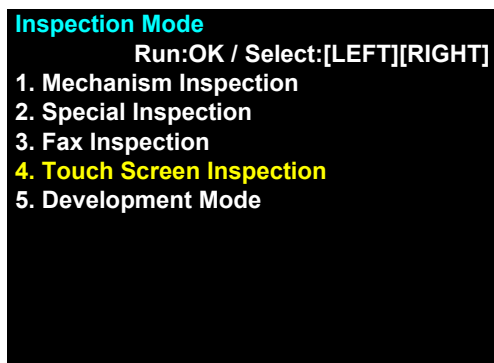


Figure 5-46. Touch Panel Adjustment (1)

3. Select “Touch Screen Calibration” and press LCD.



Figure 5-47. Touch Panel Adjustment (2)

4. Press LCD to display the adjustment screen. When aborting the adjustment, press the area other than LCD.

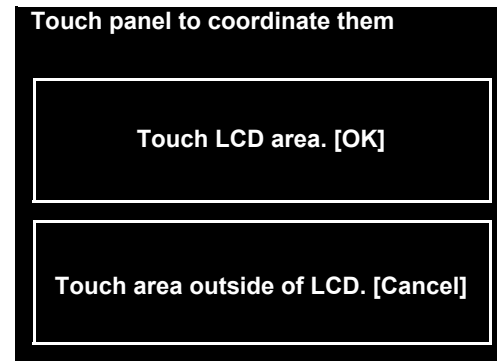


Figure 5-48. Touch Panel Adjustment (3)

5. Press “+” displayed on the four corners in order using the touch pen.

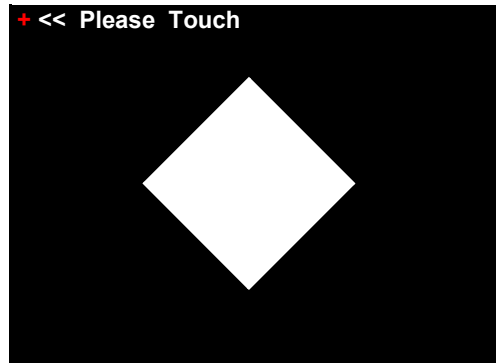


Figure 5-49. Touch Panel Adjustment (4)

6. If you retry the adjustment, press the area other than LCD and start from [Step 5](#) once again. When saving the result of adjustment, press LCD.

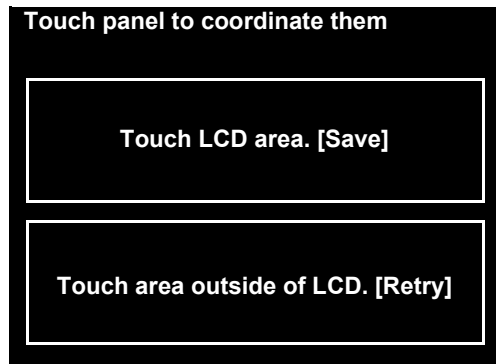


Figure 5-50. Touch Panel Adjustment (5)

7. When the confirmation pattern appears, press “+” displayed in the middle of the panel.

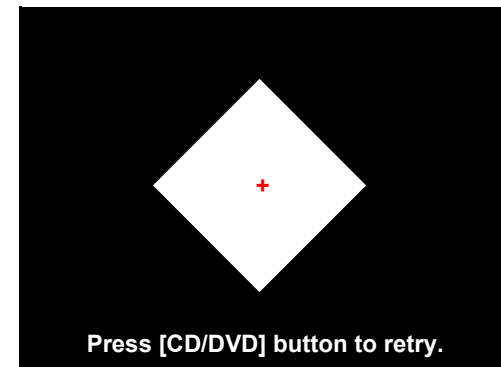


Figure 5-51. Touch Panel Adjustment (6)

8. When “Complete!” appears on LCD, press the “CD/DVD tray” button to return to the menu, and press the “power” button to complete the adjustment. If “Complete!” is not displayed, press “CD/DVD tray” button and perform [Step 7](#) once again.

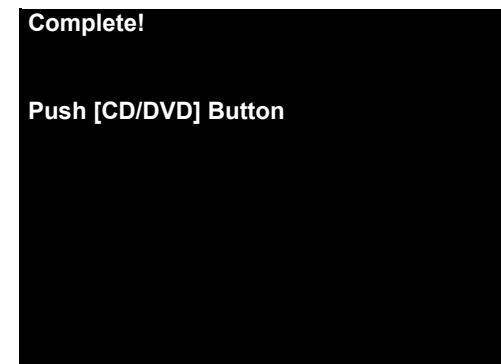


Figure 5-52. Touch Panel Adjustment (7)

5.4 Other functions

This section describes the additional functions; not adjustment items though, of the adjustment program.

5.4.1 I/S Decompress

□ Overview

This printer is equipped with the ink supply mechanism that pressurizes ink constantly even though the printer is turned off. Therefore, the following phenomena occur during servicing.

- If the joint of the ink supply tubes connected with the printhead is removed, the ink in the ink tube flows out and contaminates the surroundings.
- The ink flowed out from the joint of the ink supply tubes and the printhead gets into the decompression tube of the ink tube.
- At the leak check, the ink flows out from the joint of the ink tube and the printhead or the nozzle of the printhead.

To prevent this from happening, execute this “I/S Decompress”, and discharge ink in the ink supply path via the Ink System (Cap) out of the printer. This minimizes the risk of affect on servicing and quality.

□ Preparation

Before executing the I/S Decompress, make the following preparations:

- Remove the Waste Ink Tray Assy to discharge the waste ink out of the printer. (See ["4.2.4.20 Waste Ink Tray Assy \(p163\)"](#))

CHECK
POINT



- Prepare a container to store the spilled ink from the waste ink tube to prevent contaminating the surroundings.
- Replace necessary parts after executing I/S Decompress. Make sure to install the Waste Ink Tray Assy before start “Leak Check”.
- When IS Decompress is executed, the auto cleaning setting (ACL setting) is automatically turned off by the adjustment program to minimize the ink consumption for ink charge after assembling the printer. For this reason, record the setting following the instructions of adjustment program, and restore the setting accordingly on the “ink charge” screen before returning the printer to the users.

□ Procedure

1. Start the adjustment program, and select “I/S Decompress” from the menu.

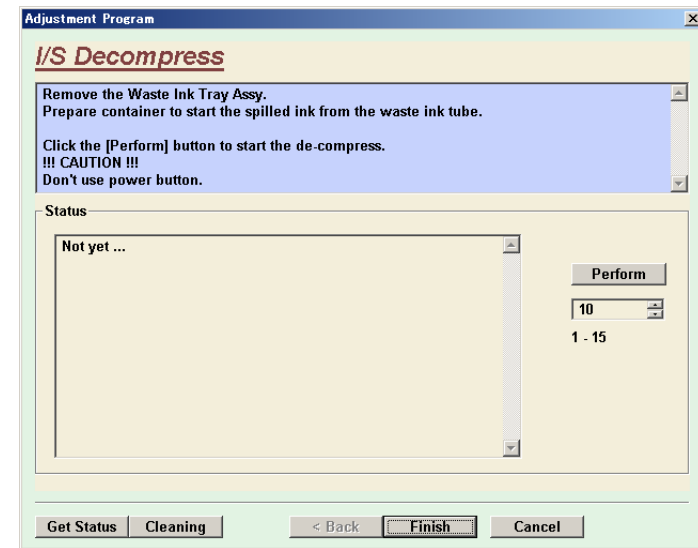


Figure 5-53. I/S Decompress Screen

2. Press the “Perform” button, and perform the operation according to the instruction displayed on the adjustment program.

CAUTION



In the next step to turn the printer off, make sure to turn it off forcibly by unplugging the AC cable, not using the “Power” button on the control panel.

3. Unplug the AC cable to turn the printer off according to the instruction displayed on the adjustment program.
4. Make sure that the printer is turned off, perform the required disassembling/reassembling operations.

CHECK
POINT



For IS Decompress, ink will discharge for ten times by default considering the result of ink discharging test. The number of times of discharging can be chosen from one to fifteen though, the ink may remain in the ink supply path if discharging is performed only fewer times (if not sufficient).

5.4.2 AID SHK Error Reset

□ Overview

When a fatal error related to AID (AID SHK error) occurs, it cannot be cancelled unless resetting the specified error counter. To locate the error part in the above situation, AID SHK Error Reset allows you to cancel the fatal error once by resetting the related error counter.

□ Symptom in which the error part can be located using this function

This function allows you to cancel the fatal error only if the fatal error code matches the following. Any other fatal error cannot be cancelled by this function.

Error Code	Fatal Error Name
96H	AID SHK error



- When checking the fatal error code, select “Printer information check” from the menu of the adjustment program.
- An AID SHK error occurs when the number of times; judged in the AID inspection as the whole one row of the nozzles of the printhead has been clogged, exceeds the specified value. The following causes of this symptom can be presumed; the case that the nozzles are physically clogged, and the case that a false-positive detection occurs due to the broken AID board or the wrong connection between the AID board and the ink system.

□ Procedure

1. Select “AID SHK Error Reset” from the menu of the adjustment program, and press the “Reset” button.

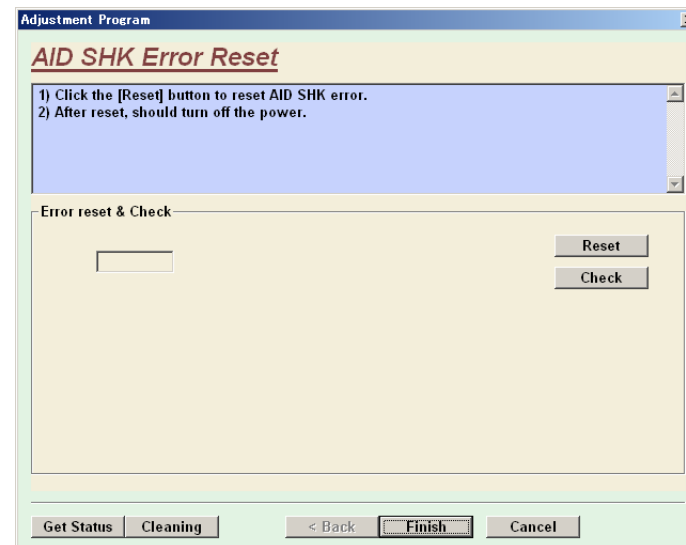


Figure 5-54. AID SHK Error Reset Screen

2. To save the data to the EEPROM, turn off the printer once, and restart it.
3. Select “AID SHK Error Reset” from the menu of the adjustment program again, and press the “Check” button, and confirm that the counter is initialized.



In the next step; when executing a manual cleaning, make sure to run it from the control panel on the printer, not by the cleaning of the adjustment program.

4. Follow the flowchart below to locate the cause of trouble.

5. After replacing appropriate parts in step 4, turn on the printer, select “AID SHK Error Reset” from the menu of the adjustment program again, and press the “Check” button to confirm that the value of the counter is not increased. If the value is increased or the same fatal error occurs repeatedly, return to step 1 and continue to locate the cause of trouble.

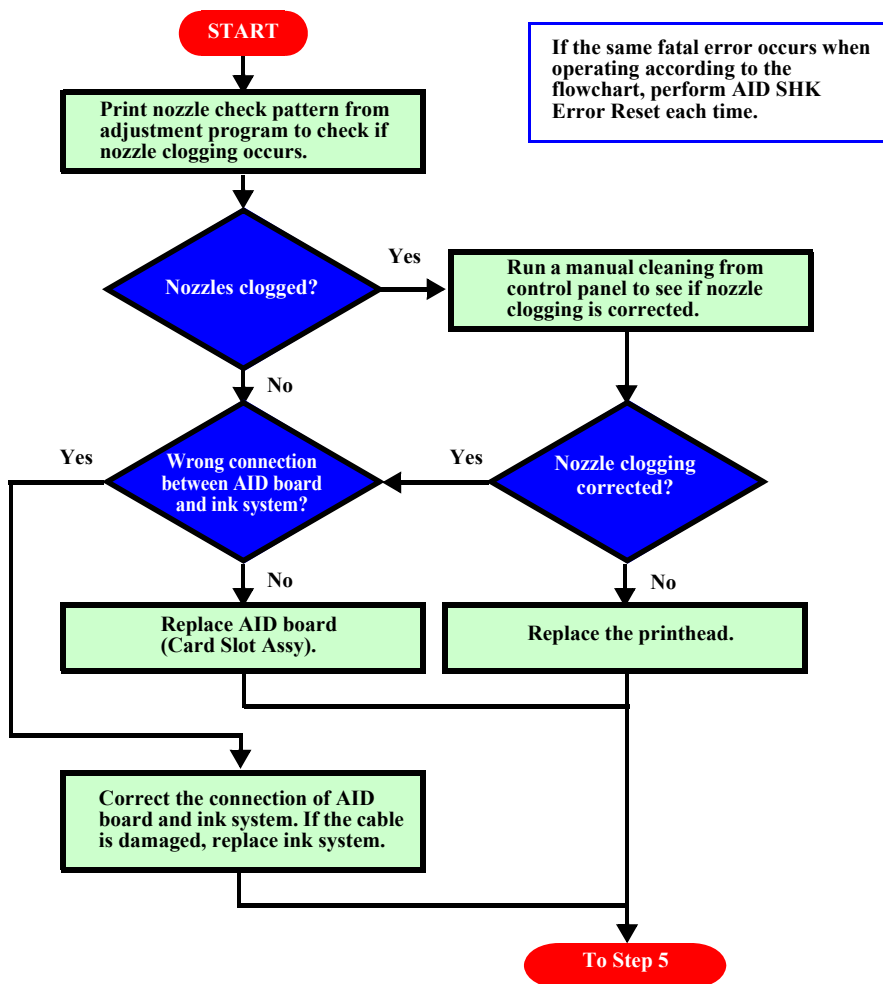


Figure 5-55. Flowchart for locating the cause of trouble

CHAPTER

6

MAINTENANCE

6.1 Overview

This section provides information to maintain the printer in its optimum condition.

6.1.1 Cleaning

This printer has no mechanical components which require regular cleaning except the Printhead. Therefore, check the following parts and perform appropriate cleaning if stain is noticeable.



- **Never use chemical solvents, such as thinner, benzene, and acetone to clean the exterior parts of the printer like the Housing. These chemicals may deform or deteriorate the components of the printer.**
- **Be careful not to damage any components when you clean inside the printer.**
- **Do not scratch the coated surface of the PF Roller. Use soft brush to wipe off any dusts. Use a soft cloth moistened with alcohol to remove the ink stain.**
- **Use a soft cloth moistened with alcohol to remove the ink stain.**
- **When using compressed air products; such as air duster, for cleaning during repair and maintenance, the use of such products containing flammable gas is prohibited.**

- Exterior parts
Use a clean soft cloth moistened with water, and wipe off any dirt. If the exterior parts have ink stain, use a cloth moistened with neutral detergent to wipe it off.
- Inside the printer
Use a vacuum cleaner to remove any paper dust.
- LD Roller/Pick Up Roller/Intermediate Roller
When paper loading function does not operate properly because of a drop in friction force of each roller due to paper dust, use a soft cloth moistened with alcohol to remove the paper dust.
- Touch Panel (Artisan 800/PX800FW/TX800FW only)
Wipe it with a dry soft cloth without applying extra force. Even if soft cloth is used, be careful not to damage the panel when using something pointing or hard with the cloth.

6.1.2 Service Maintenance

If any abnormal print (dot missing, white line, etc.) has occurred or the printer indicates the “Maintenance request error”, take the following actions to clear the error. (This error is displayed in EPSON Status Monitor 3 and on the LCD panel.)

6.1.2.1 Printhead cleaning

This product automatically checks the nozzle with the AID function at the following timing, and carries out cleaning automatically (AID detection cleaning) according to the settings of Auto Cleaning (ON/OFF), and the check result.

- Auto Cleaning ON
 - At power-on
 - When receiving FAX
 - Initial ink charge
 - After a lapse of preset time period from the previous AID detection cleaning. (performed before printing)/when ejecting the CDR Tray.
- Auto Cleaning OFF
 - When carrying out manual cleaning

There are three cleaning modes. One of the modes is automatically selected depending on the number of nozzles detected as clogged. The amount of ink consumed for the cleaning differs from modes.

6.1.2.2 Service Call

Ink is consumed also for cleaning and flushing operations. When the ink is used for cleaning and flushing operations, the ink is drained to the Waste Ink Pads (Ink Waste Tray Assy) via the Pump. The ink flushed outside of the boundary of paper when carrying out the borderless printing is conducted through the Front Paper Guide Waste Ink Pad, and drained to the Lower Paper Guide Waste Ink Pad Assy.

The amount of the waste ink is stored as the waste ink counter into the EEPROM. When the waste ink counter has reached the limit of the absorbing capability of the Waste Ink Pads, the maintenance request error is displayed. This printer takes the ink evaporation amount into consideration, therefore the counter limit differs depending on how often printing is made.



For display of Maintenance request error, see the following.

- [Chapter 3 TROUBLESHOOTING \(p.53\)](#)

When the maintenance request error appears, replace the Waste ink pads (Ink Waste Tray Assy) with a new one and reset the waste ink counter using the Adjustment program. If the waste ink counter is close to its limit, recommend that the Waste ink pads (Ink Waste Tray Assy) will be replaced with new one. This is because the “Maintenance request error” will may occur after returning the repaired product to the customer.

6.1.3 Lubrication

The type and amount of the grease used to lubricate the printer parts are determined based on the results of the internal evaluations. Be sure to apply the specified type and amount of the grease to the specified parts during servicing mentioned below.

- When a part that need lubrication is replaced
- As the need arises during disassembly/reassembly of the printer



- **Never use oil or grease other than those specified in this manual. Use of different types of oil or grease may damage the component and adversely affect the printer operation.**
- **Observe the specified amount. Never apply excess.**

Type	Name	EPSON CODE	Supplier
Grease	G-71	1304682	EPSON
Grease	G-74	1409257	EPSON

□ Refer to the following figures for the lubrication points.

	<p><Lubrication Points></p> <ol style="list-style-type: none"> Two contact points between the Carriage Unit and the Carriage Shaft. Two contact points between the Carriage Unit and the CR guide plate. Two lubrication holes on top of the Carriage Unit.
	<p><Type></p> <p>G-71</p>
	<p><Application Amount></p> <ol style="list-style-type: none"> 100 ± 20 mg 170 ± 20 mg 190 ± 20 mg
	<p><Application Timing></p> <p>After installing the Carriage Unit and the Carriage Shaft</p>
	<p><Remarks></p> <p>Apply with injector</p> <ol style="list-style-type: none"> After lubrication, move the Carriage Unit from side to side while rotating the Carriage Shaft to spread the grease evenly.

Figure 6-1. Lubrication of the Carriage Shaft and CR guide plate

	<p><Lubrication Points></p> <ol style="list-style-type: none"> Contact points between the PG Cam L and Left Parallelism Bushing Contact points between the PG Cam R and Right Parallelism Bushing
	<p><Type></p> <p>G-71</p>
	<p><Application Amount></p> <ol style="list-style-type: none"> φ 1 x sliding surface φ 1 x sliding surface
	<p><Application Timing></p> <p>After installing the PG Cam L and the PG Cam R</p>
	<p><Remarks></p> <p>Apply with injector</p>

Figure 6-2. Lubrication of the Left PG Cam and Right PG Cam

	<p><Lubrication Points></p> <ol style="list-style-type: none"> Sliding surface of the Left Front PG Cam Sliding surface of the Right Front PG Cam
	<p><Type></p> <p>G-71</p>
	<p><Application Amount></p> <ol style="list-style-type: none"> φ 1 x sliding surface φ 1 x sliding surface
	<p><Application Timing></p> <p>Before installing the Left Front PG Cam and Right Front PG Cam</p>
	<p><Remarks></p> <p>Apply with injector</p>

Figure 6-3. Lubrication of the Left Front PG Cam and Right Front PG Cam

	<p><Lubrication Points></p> <ol style="list-style-type: none"> 1. Four contact points between the Driven Pulley Holder and the Main Frame 2. The center of the Driven Pulley (bushing)
	<p><Type></p> <p>G-71</p>
	<p><Application Amount></p> <ol style="list-style-type: none"> 1. ϕ 1 x sufficient quantity 2. ϕ 1 x 1 mm
	<p><Application Timing></p> <p>Before installing the Driven Pulley Assy</p>
	<p><Remarks></p> <p>Apply with injector</p>

Figure 6-4. Lubrication of the Driven Pulley Assy

	<p><Lubrication Points></p> <p>Seven contact points between the bushings of the Paper Guide Front Assy and EJ Roller Shaft/PF Roller Shaft.</p>
	<p><Type></p> <p>G-71</p>
	<p><Application Amount></p> <p>ϕ 1 x sufficient quantity</p>
	<p><Application Timing></p> <p>Before installing the Paper Guide Front Assy</p>
	<p><Remarks></p> <p>Apply with brush</p>

Figure 6-6. Lubrication of the Paper Guide Front Assy

	<p><Lubrication Points></p> <p>The centers of the Driven Pulleys (bushings) (x2)</p>
	<p><Type></p> <p>G-71</p>
	<p><Application Amount></p> <p>ϕ 1 x 1 mm</p>
	<p><Application Timing></p> <p>Before installing the Driven Pulley Timing Assy</p>
	<p><Remarks></p> <p>Apply with injector</p>

Figure 6-5. Lubrication of the Driven Pulley Timing Assy

	<p><Lubrication Points></p> <ol style="list-style-type: none"> 1. Two points at the slits of the Sub Cassette Slider 2. Two points at the bearings of the Sub Cassette Slider
	<p><Type></p> <p>G-74</p>
	<p><Application Amount></p> <p>Sufficient quantity</p>
	<p><Application Timing></p> <p>Before installing the Cassette Assy</p>
	<p><Remarks></p> <p>Apply with brush</p>

Figure 6-7. Lubrication of the Sub Cassette Slider

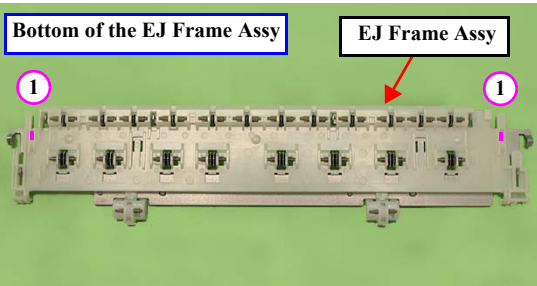
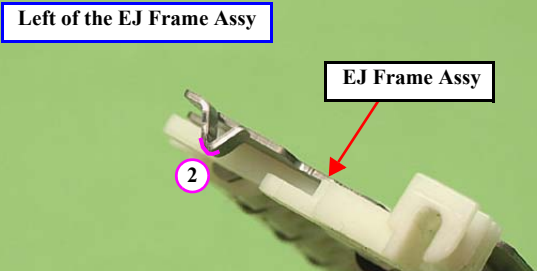
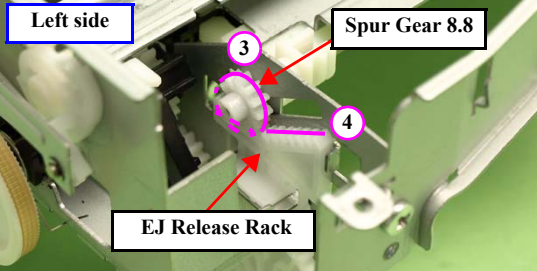
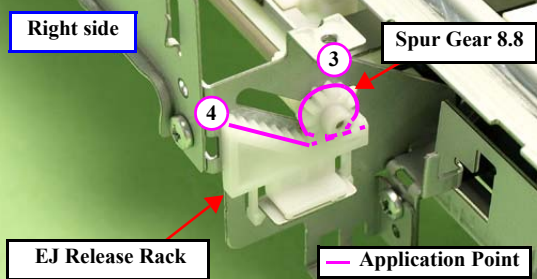
 <p>Bottom of the EJ Frame Assy</p> <p>EJ Frame Assy</p> <p>1</p>	<p><Lubrication Points></p> <ol style="list-style-type: none"> Two contact points between the EJ Frame Assy and the Paper Guide Front Assy Contact point between the left side of EJ Frame Assy L and the EJ Release Frame Assy L Spur Gear 8.8 (L/R) (x2) Toothed areas of EJ Release Rack (L/R) (x2)
 <p>Left of the EJ Frame Assy</p> <p>EJ Frame Assy</p> <p>2</p>	<p><Type></p> <p>G-71</p> <p><Application Amount></p> <ol style="list-style-type: none"> $\phi 2$ x sufficient quantity Sufficient quantity $\phi 1 \times 1$ circle $\phi 1 \times$ toothed areas
 <p>Left side</p> <p>Spur Gear 8.8</p> <p>EJ Release Rack</p> <p>3</p> <p>4</p>	<p><Application Timing></p> <p>(1), (2) Before installing the EJ Frame Assy</p> <p>(3), (4) Before installing the EJ Release Frame Assy L/R</p>
 <p>Right side</p> <p>Spur Gear 8.8</p> <p>EJ Release Rack</p> <p>3</p> <p>4</p> <p>Application Point</p>	<p><Remarks></p> <p>Apply with injector</p>

Figure 6-8. Lubrication of the EJ Release Assy L/R and EJ Release Racks

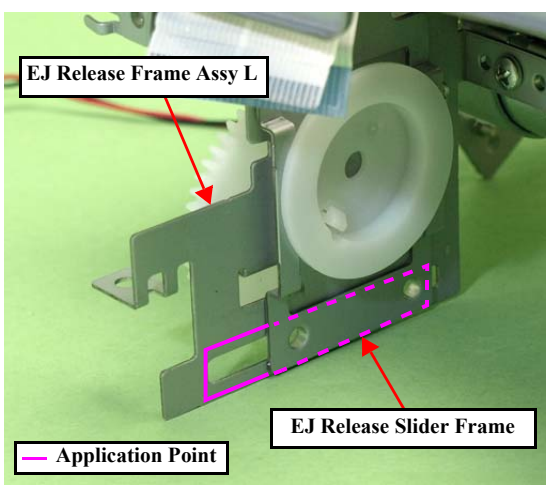
 <p>EJ Release Frame Assy L</p> <p>EJ Release Slider Frame</p> <p>Application Point</p>	<p><Lubrication Points></p> <p>Contact point between the EJ Release Frame Assy L and the EJ Release Slider Frame</p> <p><Type></p> <p>G-71</p> <p><Application Amount></p> <p>Sufficient quantity</p> <p><Application Timing></p> <p>Before installing the EJ Release Frame Assy L</p> <p><Remarks></p> <p>Apply with brush</p>
----------------------------------------------------------------------------------------------------------------------------------------------------------------------------	---------------------------------------------------------------------------------------------------------------------------------------------------------------------------------------------------------------------------------------------------------------------------------------------------------------------------------------------------------------

Figure 6-9. Lubrication of the EJ Release Frame Assy L

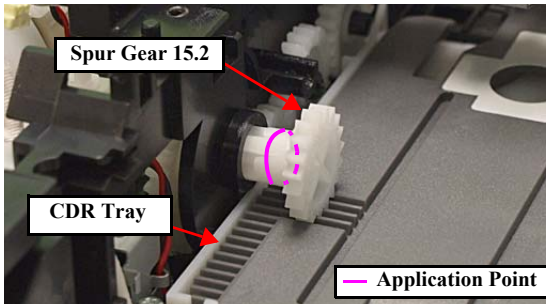
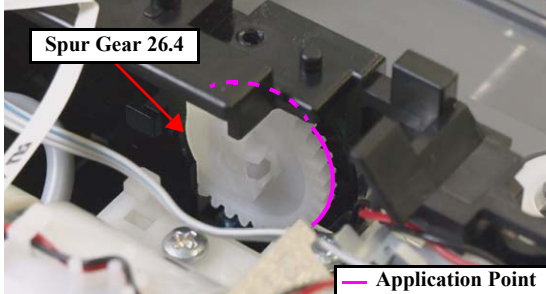
 <p>Spur Gear 15.2</p> <p>CDR Tray</p> <p>Application Point</p>	<p><Lubrication Points></p> <ol style="list-style-type: none"> On the shaft of Spur Gear 15.2 On the toothed area of Spur Gear 26.4 <p><Type></p> <p>G-71</p>
 <p>Spur Gear 26.4</p> <p>Application Point</p>	<p><Application Amount></p> <ol style="list-style-type: none"> $\phi 1 \times 1$ circle $\phi 1 \times$ half circle <p><Application Timing></p> <p>Before installing the CDR Tray</p> <p><Remarks></p> <p>Apply with injector</p>

Figure 6-10. Lubrication of the Spur Gear 15.2 and Spur Gear 26.4

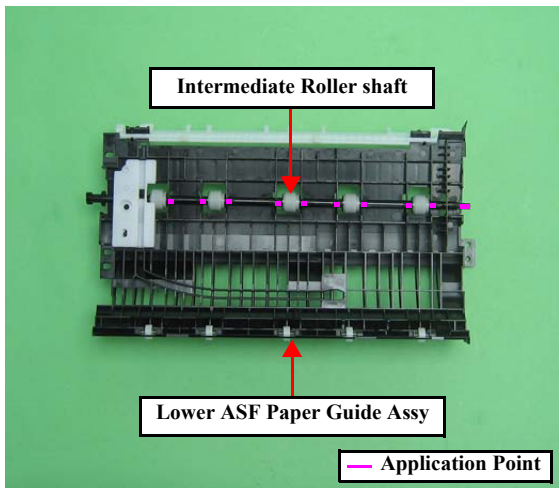
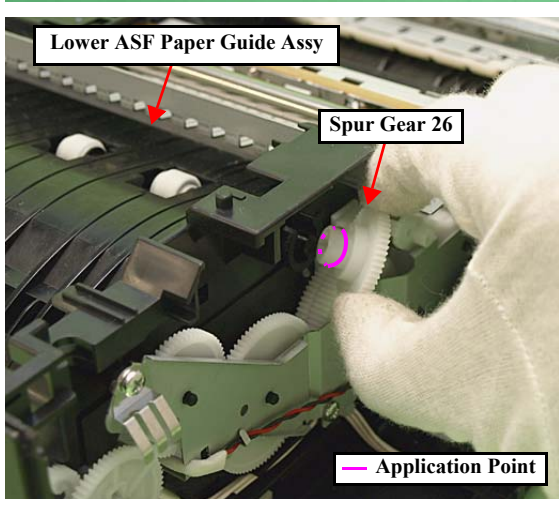
 <p>Intermediate Roller shaft</p> <p>Lower ASF Paper Guide Assy</p> <p>Application Point</p>	<p><Lubrication Points></p> <ol style="list-style-type: none"> 1. Ten contact points between the Intermediate Roller shaft and the Lower ASF Paper Guide Assy 2. On the shaft of Spur Gear 26 <p><Type></p> <p>G-71</p> <p><Application Amount></p> <ol style="list-style-type: none"> 1. ϕ 1 x 1 circle 2. ϕ 1 x 1 circle <p><Application Timing></p> <p>Before installing the Lower ASF Paper Guide Assy</p>
 <p>Lower ASF Paper Guide Assy</p> <p>Spur Gear 26</p> <p>Application Point</p>	<p><Remarks></p> <p>Apply with injector</p>

Figure 6-11. Lubrication of the Lower ASF Paper Guide Assy

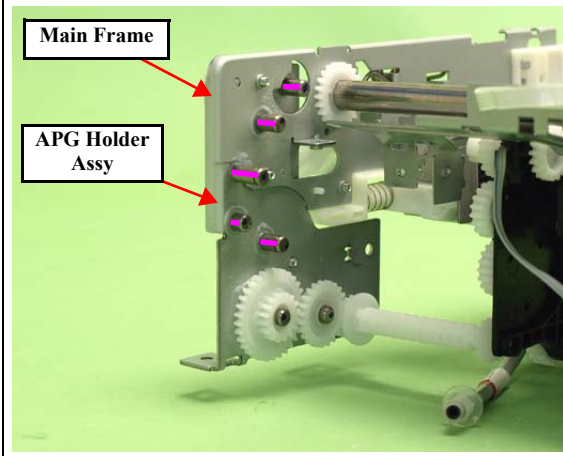
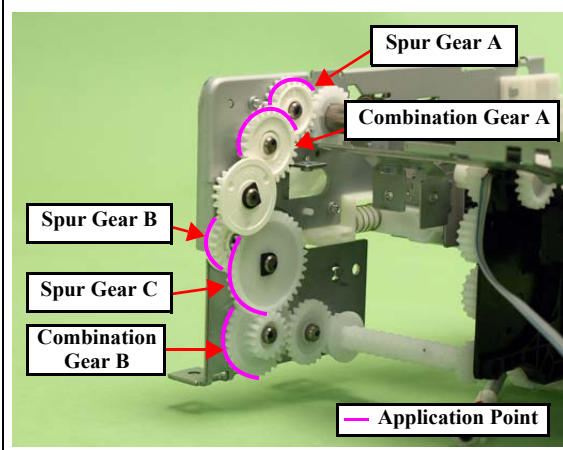
 <p>Main Frame</p> <p>APG Holder Assy</p>	<p><Lubrication Points></p> <ol style="list-style-type: none"> 1. Five points on the shafts of the Main Frame and APG Holder Assy 2. On the toothed areas of the Spur Gear A, B, C and Combination Gear A, B <p><Type></p> <p>G-71</p> <p><Application Amount></p> <ol style="list-style-type: none"> 1. ϕ 1 x 1 circle 2. ϕ 1 x half circle
 <p>Spur Gear A</p> <p>Combination Gear A</p> <p>Spur Gear B</p> <p>Spur Gear C</p> <p>Combination Gear B</p> <p>Application Point</p>	<p><Application Timing></p> <p>Before installing each gear</p> <p><Remarks></p> <p>Apply with injector</p>

Figure 6-12. Lubrication of the APG related gears

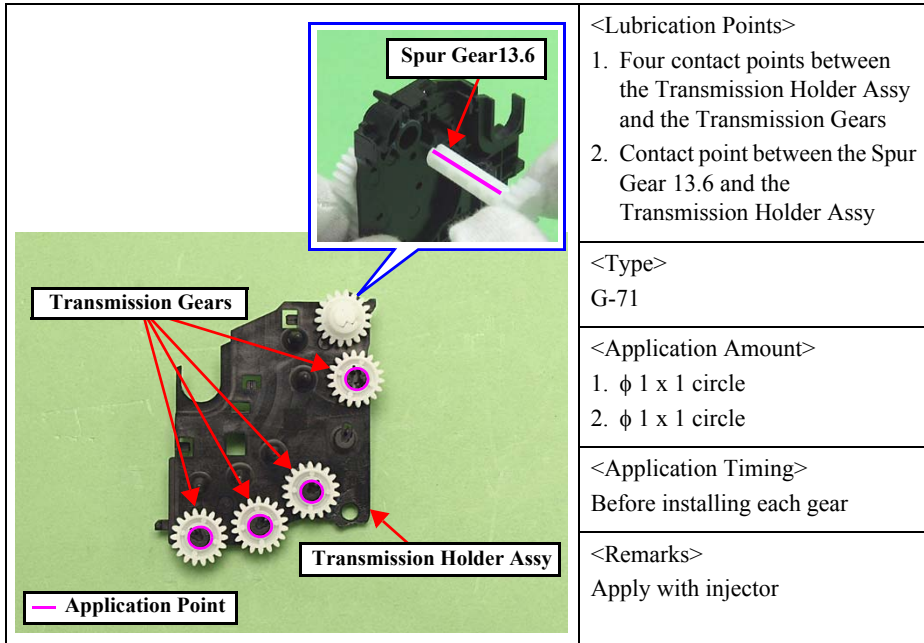


Figure 6-13. Lubrication of the Transmission Holder Assy (1)

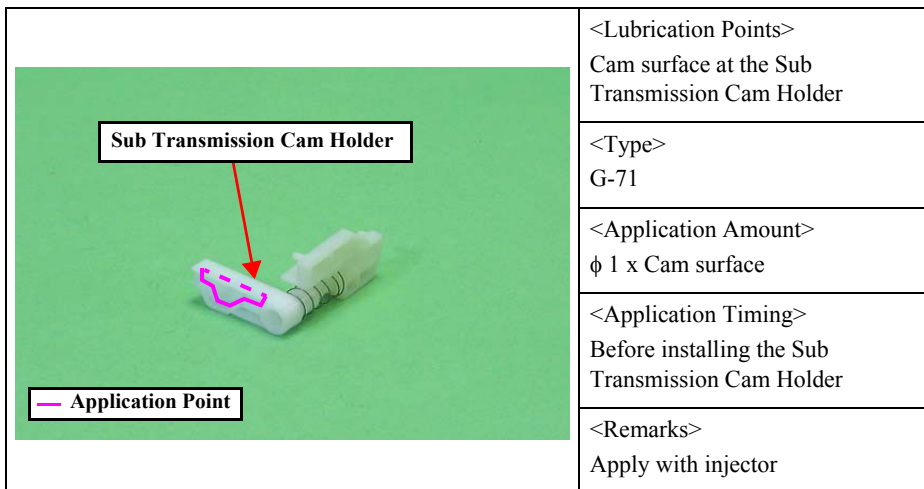


Figure 6-14. Lubrication of the Transmission Holder Assy (2)

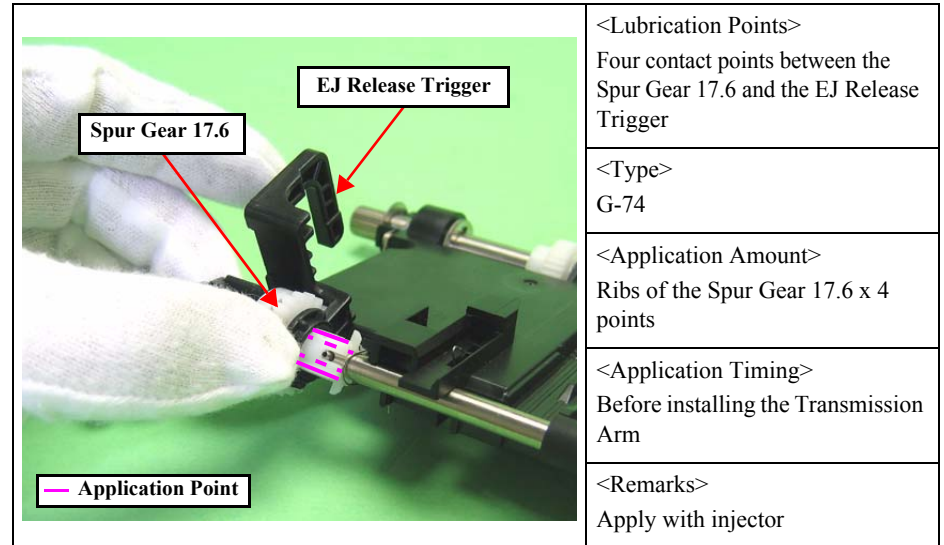


Figure 6-15. Lubrication of the Spur Gear 17.6

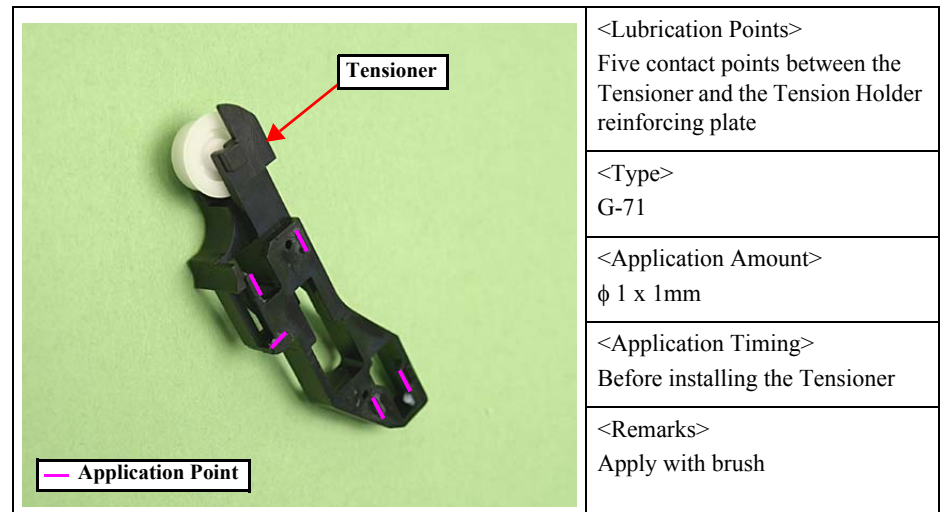


Figure 6-16. Lubrication of the Tensioner

	<p><Lubrication Points></p> <ol style="list-style-type: none"> 1. Two toothed areas of the Pick Up Roller transmission shaft 2. Two contact points between the Pick Up Roller and Pick Up Frame 3. Three contact points between the Pick Up Roller transmission shaft and Pick Up Frame
	<p><Type></p> <p>G-74</p>
	<p><Application Amount></p> <p>Sufficient quantity</p>
	<p><Application Timing></p> <p>Before installing the Pick Up Roller</p>
	<p><Remarks></p> <p>Apply with injector</p>

Figure 6-17. Lubrication of the Pick Up Roller transmission shaft

	<p><Lubrication Points></p> <ol style="list-style-type: none"> 1. On half the toothed area of the Spur Gear 36 2. On the shaft of the Base Frame
	<p><Type></p> <p>G-71</p>
	<p><Application Amount></p> <p>Sufficient quantity</p>
	<p><Application Timing></p> <p>Before installing the CDR Guide</p>
	<p><Remarks></p> <p>Apply with injector</p>

Figure 6-18. Lubrication of the Spur Gear 36

	<p><Lubrication Points></p> <p>Two Contact points between the LD Roller shaft and the Base Frame</p>
	<p><Type></p> <p>G-71</p>
	<p><Application Amount></p> <p>φ 1 x 1 circle</p>
	<p><Application Timing></p> <p>Before installing the LD Roller shaft</p>
	<p><Remarks></p> <p>Apply with injector</p>

Figure 6-19. Lubrication of the LD Roller shaft

	<p><Lubrication Points></p> <p>Two contact points between the Intermediate Roller shaft and the Base Frame</p>
	<p><Type></p> <p>G-71</p>
	<p><Application Amount></p> <p>φ 1 x 1 circle</p>
	<p><Application Timing></p> <p>Before installing the Intermediate Roller shaft</p>
	<p><Remarks></p> <p>Apply with injector</p>

Figure 6-20. Lubrication of the Intermediate Roller Shaft

	<p><Lubrication Points> Contact points between the Base Frame and the Combination Gear A, B and Spur Gear A</p>
	<p><Type> G-71</p>
	<p><Application Amount> φ 1 x 1 circle</p>
	<p><Application Timing> Before installing the LD Roller Shaft and the Intermediate Roller Shaft</p>
	<p><Remarks> Apply with injector</p>

Figure 6-21. Lubrication of the Base Frame

	<p><Lubrication Points> On the CDR Guide</p>
	<p><Type> G-74</p>
	<p><Application Amount> Sufficient quantity all along</p>
	<p><Application Timing> Before installing the CDR Guide</p>
	<p><Remarks> Apply with injector</p>

Figure 6-22. Lubrication of the CDR Guide

	<p><Lubrication Points> On the shaft of the Panel Unit (3mm away from the left end)</p>
	<p><Type> G-71</p>
	<p><Application Amount> φ 1 x 10mm</p>
	<p><Application Timing> Before installing the Panel Unit</p>
	<p><Remarks> Apply with injector</p>

Figure 6-23. Lubrication of the Panel Unit (Artisan 700/PX700W/TX700W)

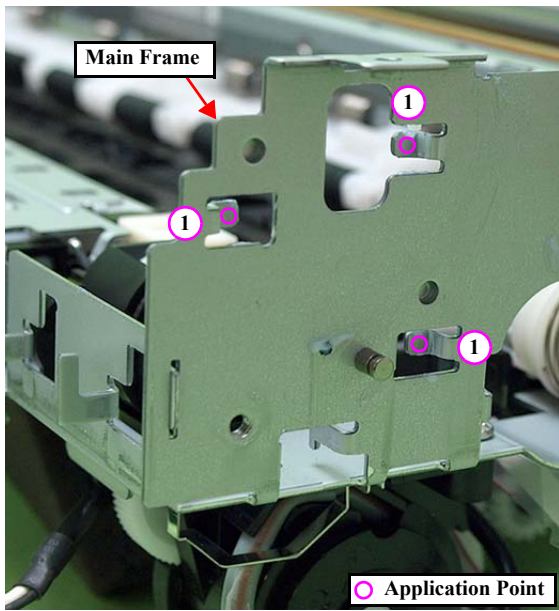
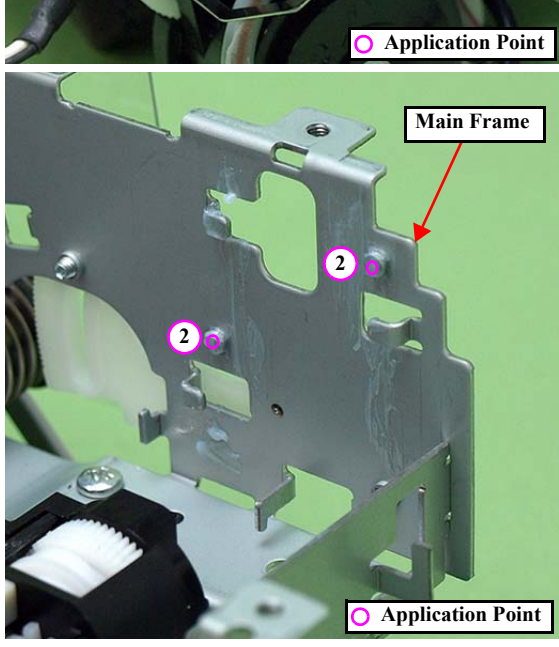
	<p><Lubrication Points></p> <ol style="list-style-type: none"> 1. Contact points between the Main Frame and the fixing plate R. (Three hooks) 2. Contact points between the Main Frame and the fixing plate R. (Two dowels)
	<p><Type></p> <p>G-71</p>
	<p><Application Amount></p> <ol style="list-style-type: none"> 1. ϕ 3 x sufficient quantity 2. ϕ 1 x sufficient quantity
	<p><Application Timing></p> <p>Before installing the fixing plate R.</p>
	<p><Remarks></p> <p>Apply with injector</p>

Figure 6-24. Lubrication of the Main Frame on the right

CHAPTER

7

APPENDIX

7.1 Connector Summary

This section shows the connections between the main components of the printer.

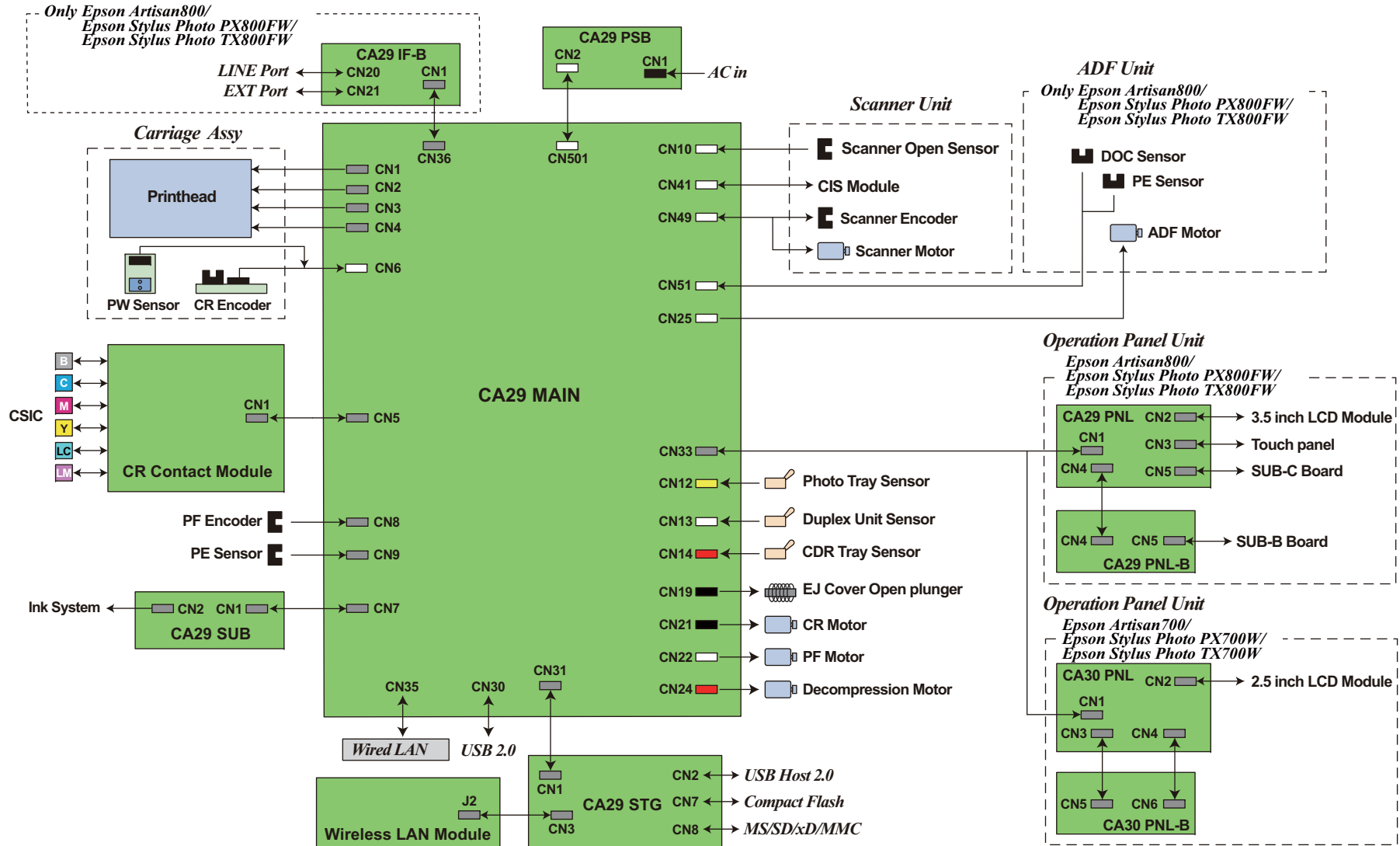


Figure 7-1. Block Diagram

7.2 Exploded Diagram / Parts List

This manual does not provide exploded diagrams or parts list.